

# Panasonic

Hybrid IP-PBX

User Manual

---

KX-TDA30/KX-TDA100  
Model KX-TDA200/KX-TDA600



Thank you for purchasing a Panasonic Hybrid IP-PBX.  
Please read this manual carefully before using this product and save this manual for future use.

**KX-TDA30: PSMPR Software File Version 4.0000 or later**  
**KX-TDA100/KX-TDA200: PMPR Software File Version 3.2000 or later**  
**KX-TDA600: PLMPR Software File Version 3.1000 or later**

## Feature Highlights

### Call Centre

This PBX can establish Incoming Call Distribution Groups (ICD Group) by which a large volume of calls from the external customers could be received. One extension can act as the supervisor, and monitor other group members.

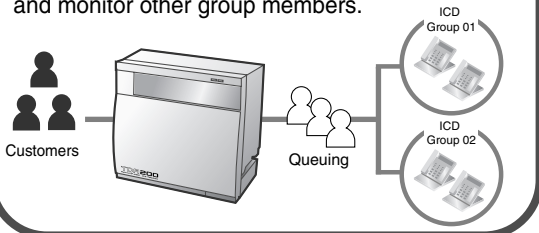

1.9 Utilising the Call Centre (Page 134)

### Voice Mail Integration

You can forward your calls to a voice processing system and let calling parties leave messages in your mailbox when you are unable to receive calls.



1.10.5 If a Voice Processing System is Connected (Page 146)

### Wireless System

This PBX optionally supports a Portable Station (PS) system. PSs can be used in the PBX with other wired telephones.



Appendix (Page 215)

### PC Phone/PC Console

This PBX supports the PC Phone/PC Console when your computer is connected to certain Panasonic telephones via USB interface. The PC Phone/PC Console provides advanced control and monitoring of your PBX.

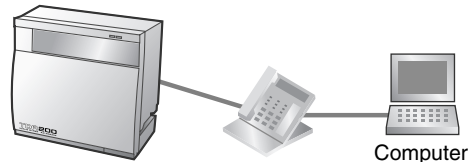

Consult your dealer

### Easy Operation

If you are using a certain Panasonic telephone that is equipped with a Navigator Key/Jog Dial and a display, it helps you to access the desired feature easily. Also, you will be informed of the arrival of an incoming call or a message waiting by the lamp if it is equipped.

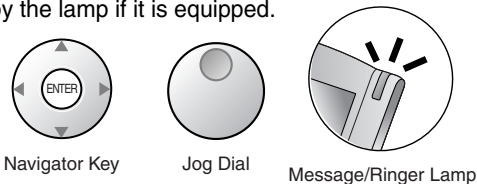

1.1 Before Operating the Telephones (Page 14)

### Call Record (Station Message Detail Recording)

This PBX can record or print out call information: date, time, extension no., dialled no., duration, etc.

Date	Time	Ext	.....
01/02/02	10:03AM	1230	.....
01/02/02	11:07AM	2230	.....

Consult your dealer

---

### ***Built-in Simplified Voice Message***

You can set incoming calls to be redirected to your message box to let callers leave voice messages when you are unable to answer the phone.

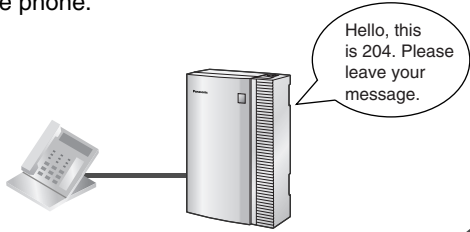

1.6.2 Using Voice Messaging (Built-in Simplified Voice Message [SVM]) (KX-TDA30 only) (Page 97)

---

## In This Manual,

- The following abbreviations are used:
  - APT → Analogue Proprietary Telephone
  - Display PT → Proprietary Telephone with a Display
  - DPT → Digital Proprietary Telephone
  - IP-PT → IP Proprietary Telephone
  - PS → Portable Station
  - PT → Proprietary Telephone
  - SLT → Single Line Telephone
- The suffix of each model number is omitted.
- The illustrations of the PBX are based on the KX-TDA200.
- The following icons are used frequently.



## Important Notice

Prior to connection of this product, please verify that the intended operating environment is supported. Satisfactory performance cannot be guaranteed for the following:

- interoperability and compatibility with all devices and systems connected to this product
- proper operation and compatibility with services provided by telecommunications companies over connected networks

## NOTES

- This manual provides basic information on how you can access commonly used PBX functions with proprietary telephones (PTs), single line telephones (SLTs), portable stations (PSs), and DSS Consoles. For detailed information about each feature or setting, consult your dealer.
- In this manual, several kinds of PTs appear, as follows:
  - IP Proprietary Telephone (IP-PT)
  - Digital Proprietary Telephone (DPT)
  - Analogue Proprietary Telephone (APT)
  - Proprietary Telephone with a Display (Display PT)"PT" is used as a generic term to represent all of these PTs. If a PBX feature only supports specific PTs, such as IP-PTs, the available telephone types are clearly indicated.
- IP-PTs may become busy and you may not be able to make or receive calls, depending on the network status.
- The contents of this manual apply to PBXs with a certain software version, as indicated on the cover of this manual. To confirm the software version of your PBX, consult your dealer.
- Product specifications are subject to change without notice.

---

# ***Important Information***

## **WARNING**

- **THIS UNIT MAY ONLY BE INSTALLED AND SERVICED BY QUALIFIED SERVICE PERSONNEL.**
- **IF DAMAGE TO THE UNIT EXPOSES ANY INTERNAL PARTS, DISCONNECT THE POWER SUPPLY CORD IMMEDIATELY AND RETURN THE UNIT TO YOUR DEALER.**
- **UNPLUG THIS UNIT FROM THE AC OUTLET IF IT EMITS SMOKE, AN ABNORMAL SMELL OR MAKES UNUSUAL NOISE. THESE CONDITIONS CAN CAUSE FIRE OR ELECTRIC SHOCK. CONFIRM THAT SMOKE HAS STOPPED AND CONTACT AN AUTHORISED PANASONIC FACTORY SERVICE CENTRE.**
- **WHEN RELOCATING THE EQUIPMENT, FIRST DISCONNECT THE TELECOM CONNECTION BEFORE DISCONNECTING THE POWER CONNECTION. WHEN THE UNIT IS INSTALLED IN THE NEW LOCATION, RECONNECT THE POWER FIRST, AND THEN RECONNECT THE TELECOM CONNECTION.**
- **THIS UNIT IS EQUIPPED WITH AN EARTHED PLUG. FOR SAFETY REASONS THIS PLUG MUST ONLY BE CONNECTED TO AN EARTHED OUTLET THAT HAS BEEN INSTALLED ACCORDING TO APPLICABLE REGULATIONS.**
- **TO PREVENT POSSIBLE FIRE OR ELECTRIC SHOCK, DO NOT EXPOSE THIS PRODUCT TO RAIN OR MOISTURE.**
- **THE POWER SUPPLY CORD IS USED AS THE MAIN DISCONNECT DEVICE. ENSURE THAT THE AC OUTLET IS LOCATED NEAR THE EQUIPMENT AND IS EASILY ACCESSIBLE.**
- **TO PROTECT THIS UNIT FROM STATIC ELECTRICITY, DO NOT TOUCH ANY EXTERNAL CONNECTORS OF THE UNIT.**

## **Safety Instructions**

When using your telephone equipment, basic safety precautions should always be followed to reduce the risk of fire, electric shock and injury to persons, including the following:

1. Do not use this product near water, for example, near a bathtub, wash bowl, kitchen sink or laundry tub, in a wet basement, or near a swimming pool.
2. Avoid using wired telephones during an electrical storm. There is a remote risk of electric shock from lightning.
3. Do not use a telephone in the vicinity of a gas leak to report the leak.
4. Use only the power cord and batteries indicated in this manual. Do not dispose of batteries in a fire, as they may explode. Dispose according to local regulations.

**SAVE THESE INSTRUCTIONS**



The KX-TDA30E, KX-TDA30NE, KX-TDA30GR, and KX-TDA30CE are designed to interwork with the:

- Analogue Public Switched Telephone Network (PSTN) of European countries
- Pan-European Integrated Services Digital Network (ISDN) using ISDN basic rate access

The KX-TDA100E/KX-TDA200E, KX-TDA100NE/KX-TDA200NE, KX-TDA100GR/KX-TDA200GR, and KX-TDA100CE/KX-TDA200CE are designed to interwork with the:

- Analogue Public Switched Telephone Network (PSTN) of European countries
- Pan-European Integrated Services Digital Network (ISDN) using ISDN basic rate access
- Pan-European Integrated Services Digital Network (ISDN) using ISDN primary rate access
- ONP 2048 kbit/s digital structured leased lines (D2048S)

The KX-TDA600E, KX-TDA600NE, KX-TDA600GR, and KX-TDA600CE are designed to interwork with the:

- Analogue Public Switched Telephone Network (PSTN) of European countries
- Pan-European Integrated Services Digital Network (ISDN) using ISDN basic rate access
- Pan-European Integrated Services Digital Network (ISDN) using ISDN primary rate access
- ONP 2048 kbit/s digital structured leased lines (D2048S)

Panasonic Communications Co., Ltd./Panasonic Communications Company (U.K.) Ltd. declares that this equipment is in compliance with the essential requirements and other relevant provisions of Radio & Telecommunications Terminal Equipment (R&TTE) Directive 1999/5/EC.

Declarations of Conformity for the relevant Panasonic products described in this manual are available for download by visiting:

<http://www.doc.panasonic.de>

Contact:

Panasonic Services Europe  
a Division of Panasonic Marketing Europe GmbH  
Panasonic Testing Centre  
Winsbergring 15, 22525 Hamburg, Germany

---

## Attention

- Keep the unit away from heating appliances and devices that generate electrical noise such as fluorescent lamps, motors, and televisions. These noise sources can interfere with the performance of the PBX.
- This unit should be kept free of dust, moisture, high temperature (more than 40 °C), and vibration, and should not be exposed to direct sunlight.
- If you are having problems making calls to outside destinations, follow this procedure to test the outside lines:
  1. Disconnect the PBX from all outside lines.
  2. Connect known working single line telephones (SLTs) to those outside lines.
  3. Make a call to an external destination using those SLTs.

If a call cannot be carried out correctly, there may be a problem with the outside line that the SLT is connected to. Contact your telephone company.

If all SLTs operate properly, there may be a problem with your PBX. Do not reconnect the PBX to the outside lines until it has been serviced by an authorised Panasonic Factory Service Centre.

- Never attempt to insert wires, pins, etc. into the vents or holes of this unit.
- Wipe the unit with a soft cloth. Do not clean the unit with abrasive powders or with chemical agents such as benzene or thinner.
- When using a Panasonic proprietary telephone (PT), use only the correct Panasonic handset.
- For users of PC Phone (Free Licence Version) shipped with KX-T7601 USB Module:

All features of the PC Phone software are available for 90 days from the date of installation.  
After this period expires, the following buttons on the Operation Screen will become unavailable:

  - Recording
  - TAM
  - Voice Memo
  - Text Memo
  - Speed

To continue using any of the corresponding features after the trial period, please purchase KX-TDA0350 (PC Phone, 5 licences).



---

### For users in the European Union only

- **Information on Disposal for Users of Waste Electrical & Electronic Equipment (private households)**

This symbol on the products and/or accompanying documents means that used electrical and electronic products should not be mixed with general household waste. For proper treatment, recovery and recycling, please take these products to designated collection points, where they will be accepted on a free of charge basis. Alternatively, in some countries you may be able to return your products to your local retailer upon the purchase of an equivalent new product. Disposing of this product correctly will help to save valuable resources and prevent any potential negative effects on human health and the environment which could otherwise arise from inappropriate waste handling. Please contact your local authority for further details of your nearest designated collection point. Penalties may be applicable for incorrect disposal of this waste, in accordance with national legislation.

- **For business users in the European Union**

If you wish to discard electrical and electronic equipment, please contact your dealer or supplier for further information.

- **Information on Disposal in other Countries outside the European Union**

This symbol is only valid in the European Union. If you wish to discard this product, please contact your local authorities or dealer and ask for the correct method of disposal.



### For users in New Zealand only

- This equipment shall not be set to make automatic calls to the Telecom '111' Emergency Service.
- The grant of a Telepermit for any item of terminal equipment indicates only that Telecom has accepted that the item complies with minimum conditions for connection to its network. It indicates no endorsement of the product by Telecom, nor does it provide any sort of warranty. Above all, it provides no assurance that any item will work correctly in all respects with another item of Telepermitted equipment of a different make or model, nor does it imply that any product is compatible with all of Telecom's network services.
- **IMPORTANT NOTICE**  
Under power failure conditions, the connected telephones may not operate. Please ensure that a separate telephone, not dependent on local power, is available for emergency use.
- **APPLICABLE ONLY TO TELECOM CUSTOMERS WHO HAVE AUTOMATIC ACCESS TO OTHER CARRIERS FOR TOLL CALLS**  
When calling back a number from the Caller ID list, all numbers prefixed with "0 + AREA CODE" will be automatically forwarded to your toll carrier. This includes numbers in your local calling area. The zero + area code should either be removed when calling back local numbers, or check with your toll carrier that a charge will not be levied.
- All persons using this device for recording telephone conversations shall comply with New Zealand law. This requires that at least one party to the conversation is to be aware that it is being recorded. In addition, the principles enumerated in the Privacy Act 1993 shall be complied with in respect to the nature of the personal information collected, the purpose for its collection, how it is used, and what is disclosed to any other party.



---

### For Future Reference

Please print, record, and retain the following information for future reference.

**Note**

The serial number of this product can be found on the label affixed to the unit. You should record the model number and the serial number of this unit as a permanent record of your purchase to aid in identification in the event of theft.

MODEL NO.	_____
SERIAL NO.	_____
DATE OF PURCHASE	_____
NAME OF DEALER	_____
DEALER'S ADDRESS	_____ _____ _____ _____
DEALER'S TEL. NO.	_____

---

# Table of Contents

<b>1</b>	<b>Operation</b>	<b>13</b>
1.1	<b>Before Operating the Telephones</b>	<b>14</b>
1.1.1	Before Operating the Telephones	14
1.2	<b>Making Calls</b>	<b>25</b>
1.2.1	Basic Calling	25
1.2.2	Easy Dialling	30
1.2.3	Redial	34
1.2.4	When the Dialed Line is Busy or There is No Answer	35
1.2.5	Accessing the ISDN Service (ISDN Service Access)	43
1.2.6	Alternating the Calling Method (Alternate Calling—Ring/Voice)	44
1.2.7	Calling without Restrictions	45
1.2.8	To Access Another Party Directly from Outside (Direct Inward System Access [DISA])	46
1.2.9	Setting Your Telephone from Another Extension or through DISA (Remote Setting)	49
1.3	<b>Receiving Calls</b>	<b>50</b>
1.3.1	Answering Calls	50
1.3.2	Answering Hands-free (Hands-free Answerback)	51
1.3.3	Answering a Call Ringing at Another Telephone (Call Pickup)	52
1.3.4	Answering a Call via an External Speaker (Trunk Answer From Any Station [TAFAS])	53
1.3.5	Using the ANSWER/RELEASE Button	54
1.3.6	Identifying Malicious Calling Parties (Malicious Call Identification [MCID])	56
1.4	<b>During a Conversation</b>	<b>57</b>
1.4.1	Transferring a Call (Call Transfer)	57
1.4.2	Holding a Call	61
1.4.3	Talking to Two Parties Alternately (Call Splitting)	65
1.4.4	Answering Call Waiting	67
1.4.5	Multiple Party Conversation	71
1.4.6	Mute	80
1.4.7	Letting Other People Listen to the Conversation (Off-hook Monitor)	81
1.4.8	Using the Headset (Headset Operation)	82
1.5	<b>Using a PDN/SDN Button</b>	<b>84</b>
1.5.1	Primary Directory Number (PDN)/Secondary Directory Number (SDN) Extension (KX-TDA100/KX-TDA200/KX-TDA600 only)	84
1.6	<b>Before Leaving Your Desk</b>	<b>88</b>
1.6.1	Forwarding Calls	88
1.6.2	Using Voice Messaging (Built-in Simplified Voice Message [SVM]) (KX-TDA30 only)	97
1.6.3	Showing a Message on the Caller's Telephone Display (Absent Message)	108
1.6.4	Preventing Other People from Using Your Telephone (Extension Dial Lock)	110
1.7	<b>Making/Answering an Announcement</b>	<b>112</b>
1.7.1	Paging	112
1.7.2	Answering/Denying a Paging Announcement	114
1.7.3	Making an Announcement and Having a Multiple Party Conversation (Broadcasting)	115
1.8	<b>Setting the Telephone According to Your Needs</b>	<b>118</b>
1.8.1	Setting the Alarm (Timed Reminder)	118
1.8.2	Refusing Incoming Calls (Do Not Disturb [DND])	120
1.8.3	Receiving Call Waiting (Call Waiting/Off-hook Call Announcement [OHCA]/Whisper OHCA)	123
1.8.4	Displaying Your Telephone Number on the Called Party and Caller's Telephone (Calling/Connected Line Identification Presentation [CLIP/COLP])	124

1.8.5	Preventing Your Telephone Number Being Displayed on the Caller's Telephone (Connected Line Identification Restriction [COLR]) .....	125
1.8.6	Preventing Your Number Being Displayed on the Called Party's Telephone (Calling Line Identification Restriction [CLIR]) .....	126
1.8.7	Preventing Other People from Joining Your Conversation (Executive Busy Override Deny) .....	127
1.8.8	Turning on the Background Music (BGM).....	128
1.8.9	Protecting Your Line against Notification Tones (Data Line Security).....	129
1.8.10	Checking the Time Service Status .....	130
1.8.11	Setting the Paralleled Telephone to Ring (Paralleled Telephone) .....	131
1.8.12	Using Your PS in Parallel with a Wired Telephone (Wireless XDP Parallel Mode) .....	132
1.8.13	Clearing Features Set at Your Extension (Extension Feature Clear).....	133
<b>1.9</b>	<b>Utilising the Call Centre</b> .....	<b>134</b>
1.9.1	Leaving an Incoming Call Distribution Group (Log-in/Log-out, Wrap-up) .....	134
1.9.2	Monitoring and Controlling the Call Status of an Incoming Call Distribution Group (Incoming Call Distribution Group Monitor) .....	137
1.9.3	Forwarding a Waiting Call (Manual Queue Redirection) .....	140
<b>1.10</b>	<b>Using User-supplied Equipment</b> .....	<b>141</b>
1.10.1	If a Doorphone/Door Opener is Connected .....	141
1.10.2	If an External Relay is Connected .....	143
1.10.3	If an External Sensor is Connected .....	144
1.10.4	If a Host PBX is Connected.....	145
1.10.5	If a Voice Processing System is Connected .....	146
<b>1.11</b>	<b>Administrative Features</b> .....	<b>152</b>
1.11.1	Using the Telephones in a Hotel-type Environment (Hospitality Features).....	152
1.11.2	Recording Information Using Preprogrammed Messages (Printing Message) .....	158
<b>1.12</b>	<b>After Moving to a New Location in the Office</b> .....	<b>159</b>
1.12.1	Using the Same Settings as Your Previous Extension (Walking Extension) .....	159
<b>1.13</b>	<b>Using a Display Proprietary Telephone</b> .....	<b>160</b>
1.13.1	Using the Call Log .....	160
1.13.2	Using the Directories .....	164
1.13.3	Accessing System Features (System Feature Access).....	172
<b>2</b>	<b>Manager Operation</b> .....	<b>173</b>
<b>2.1</b>	<b>Control Features</b> .....	<b>174</b>
2.1.1	Extension Control .....	174
2.1.2	Time Service Mode Control.....	175
2.1.3	Restriction Level Control (Dial Tone Transfer) .....	177
2.1.4	Turning on the External Background Music (BGM) .....	178
2.1.5	Recording Outgoing Messages (OGM) .....	179
2.1.6	Allowing Users to Seize an Unavailable Outside Line (Trunk Busy Out) .....	182
2.1.7	Releasing Network Direct Station Selection (NDSS) Monitor .....	183
<b>3</b>	<b>Customising Your Phone &amp; System</b> .....	<b>185</b>
<b>3.1</b>	<b>Customising Your Phone (Personal Programming)</b> .....	<b>186</b>
3.1.1	Customising Your Phone (Personal Programming) .....	186
3.1.2	Settings on the Programming Mode .....	188
3.1.3	Customising the Buttons .....	199
<b>3.2</b>	<b>Manager Programming</b> .....	<b>204</b>
3.2.1	Programming Information .....	204
3.2.2	Manager Programming.....	205
<b>3.3</b>	<b>Customising Your System (System Programming)</b> .....	<b>207</b>

---

3.3.1	Programming Information.....	207
3.3.2	System Programming.....	210
<b>4</b>	<b>Appendix .....</b>	<b>215</b>
<b>4.1</b>	<b>Troubleshooting .....</b>	<b>216</b>
4.1.1	Troubleshooting.....	216
<b>4.2</b>	<b>Feature Number Table .....</b>	<b>219</b>
4.2.1	Feature Number Table.....	219
<b>4.3</b>	<b>What is This Tone? .....</b>	<b>229</b>
4.3.1	What is This Tone?.....	229
<b>4.4</b>	<b>Revision History.....</b>	<b>233</b>
4.4.1	KX-TDA600 PLMPR Software File Version 3.1xxx .....	233
4.4.2	KX-TDA100/KX-TDA200 PMPR Software File Version 1.1xxx .....	234
4.4.3	KX-TDA100/KX-TDA200 PMPR Software File Version 2.0xxx .....	235
4.4.4	KX-TDA100/KX-TDA200 PMPR Software File Version 3.0xxx .....	236
4.4.5	KX-TDA100/KX-TDA200 PMPR Software File Version 3.2xxx .....	237
4.4.6	KX-TDA30 PSMPR Software File Version 1.1xxx .....	238
4.4.7	KX-TDA30 PSMPR Software File Version 2.0xxx .....	239
4.4.8	KX-TDA30 PSMPR Software File Version 2.2xxx .....	240
4.4.9	KX-TDA30 PSMPR Software File Version 3.0xxx .....	241
4.4.10	KX-TDA30 PSMPR Software File Version 4.0xxx .....	242
	<b>Index.....</b>	<b>245</b>

---

# **Section 1**

## **Operation**

*This chapter shows you step by step how to use each feature.  
Read this chapter to become familiar with the many useful  
features of this PBX.*

# 1.1 Before Operating the Telephones

## 1.1.1 Before Operating the Telephones

### ◆◆ What Kind of Telephone Can Be Used?

You can use a single line telephone (SLT), such as a rotary pulse telephone or a Panasonic proprietary telephone (PT) such as the KX-T7636 or KX-NT136. You can also use a Panasonic Portable Station (PS) such as the KX-TCA255 or KX-TD7690. Use the feature depending on the telephone you are using. If you

are using a Panasonic proprietary telephone with a special feature button such as  or a display (Display PT) or both, you can follow the operation with the button or display messages for easy programming.

If you use a large display telephone (e.g., KX-T7636), you can follow the displayed messages to use the features. If your telephone does not have feature buttons and/or a display, you may operate the PBX by entering a feature number instead. Follow the operation for your type of telephone.

If you use a Console, you can use the buttons on the Console as the buttons on the connected proprietary telephone.

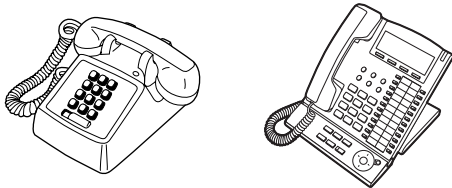

- If you use a Panasonic proprietary telephone which does not have feature buttons, you may change one of the unused flexible buttons to a feature button. Refer to "3.1.3 Customising the Buttons".

### Registration for Your Portable Station (PS)

Your PS must be registered with the PBX and assigned an extension number before initial use, through system programming. To confirm the extension number of your PS, refer to "Your extension information" in Section "3.1.2 Settings on the Programming Mode".

### ◆◆ Feature Numbers

To use certain features, you need to enter specified feature numbers (and an additional parameter, if required).

There are two types of feature numbers as follows:

- Flexible feature number
- Fixed feature number

Fixed feature numbers cannot be changed. However, you can change the flexible numbers to other numbers for easier use. In this manual, the default numbers (factory installed) are used for operations.

A flexible number is shown as  (half-shaded key). Use the new programmed number if you have changed the feature number. Write the new number in "4.2.1 Feature Number Table" (Appendix).

#### **Notice**

The default value of a flexible feature number may vary depending on country/area.



If you use a single line telephone which does not have the "\*" or "#" keys; it is not possible to access features that have "\*" or "#" in their feature numbers.

◆◆ **Tone**

You will hear various tones, during or after an operation, for confirmation. Refer to "4.3.1 What is This Tone?" (Appendix).

◆◆ **Display**

In this manual, you will see "the display ...". This refers to the display of a Panasonic proprietary telephone. If your telephone is not a Panasonic display proprietary telephone, the message will not be displayed. If you use a Panasonic display proprietary telephone, the display helps you confirm the settings. Some proprietary telephones also give you easy access to features. A message is displayed depending on the feature. By pressing the corresponding button on the side or at the bottom of the display, or pressing the Navigator Key, you can access the desired feature. Furthermore, depending on the display proprietary telephone, you can operate features or make calls using the display message. Refer to "1.13 Using a Display Proprietary Telephone".

**Notice**

In this manual, the display messages are described in English.

**Your Extension Number**

If you use a Panasonic display proprietary telephone, you can check your own extension number on the display. Press the TRANSFER button or Soft (S1) button while on-hook.

◆◆ **Using a Navigator Key/Jog Dial/Volume Key**

The Navigator Key can be used for the display contrast and the volume control or you can search for desired items on the display. Press the Navigator Key/Volume Key or rotate the Jog Dial in the desired direction. The contrast or the volume level and the items will change as follows:

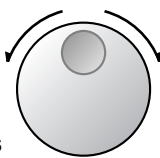
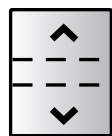
Navigator Key	Jog Dial	Volume Key
<p style="text-align: center;"><b>Up</b> (Level <b>increases</b>)</p> <p style="text-align: center;">Left    Right</p> <p style="text-align: center;"><b>Down</b> (Level <b>decreases</b>)</p> 	<p style="text-align: center;"><b>Left</b> (anti-clockwise)</p> <p style="text-align: center;">↓ Level <b>decreases</b></p> <p style="text-align: center;"></p> <p style="text-align: center;"><b>Right</b> (clockwise)</p> <p style="text-align: center;">↓ Level <b>increases</b></p>	<p style="text-align: center;"><b>Up</b> (Level <b>increases</b>)</p> <p style="text-align: center;"></p> <p style="text-align: center;"><b>Down</b> (Level <b>decreases</b>)</p>



## 1.1 Before Operating the Telephones

### ◆◆ Examples















The displays and the illustrations shown as examples are from a telephone connected to the KX-TDA200.

### ◆◆ Restrictions

Some features may be restricted at your extension depending on system programming and the type of telephone being used.

### ◆◆ Icon Descriptions

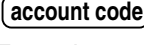

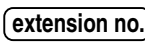
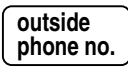
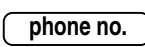
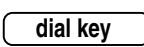











The following icons show you the feature availability, notes and action to use the features.

	This feature cannot be used with a single line telephone.	 (co) OR  OR 	Seize an outside line (One of the following). <ul style="list-style-type: none"> <li>Press the CO button.</li> <li>Dial automatic line access number 0 or 9.</li> <li>Dial outside line group access number and outside line group number.</li> </ul>
	See "Programming" for Related Programming if necessary.		
	Off-hook (One of the following). <ul style="list-style-type: none"> <li>Lift the handset.</li> <li>Press the SP-PHONE button.</li> <li>Press the MONITOR button. (To start talking, lift the handset.)</li> <li>Press TALK button.</li> </ul>		Press the Call button on the Doorphone.
	On-hook (One of the following). <ul style="list-style-type: none"> <li>Hang up.</li> <li>Press the SP-PHONE button.</li> <li>Press the MONITOR button.</li> <li>Press CANCEL button.</li> </ul>		Press the hookswitch lightly.
	Press the corresponding feature button on the proprietary telephone.		Talk.
	Enter the required number. <Example>  Enter the account code.		You will hear a busy, confirmation, dial, ring or ringback tone. <ul style="list-style-type: none"> <li>B. Tone: Busy Tone</li> <li>C. Tone: Confirmation Tone</li> <li>D. Tone: Dial Tone</li> <li>R. Tone: Ring Tone</li> <li>R. B. Tone: Ringback Tone</li> </ul>
	Dial an extension number.		Dial outside phone number.
	Dial the telephone number.		Press any dial key (0–9, *, #).



### ◆◆ When You Use a Panasonic Proprietary Telephone







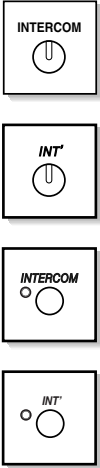

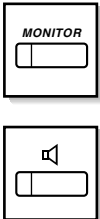
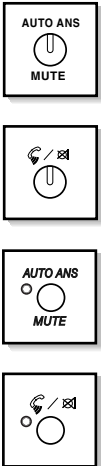
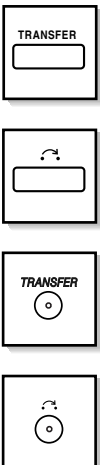
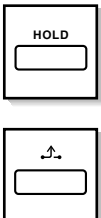





If you use a Panasonic proprietary telephone and the Console, they may have some of the useful feature buttons described below. For a PS user, refer to "Operating Instructions" for PS. These buttons make operations simple. The illustrations may differ from the buttons on your telephone.

#### Fixed Buttons















	<p><b>CO:</b> Used to make or receive an outside call. (Button assignment is required.) Also used as feature buttons. (Button assignment is required.) (Only the outside line "number" [e.g., 1, 2] may be shown on some telephones.)</p>	   	<p><b>SP-PHONE:</b> Used for hands-free operation.</p>
   	<p><b>AUTO DIAL/STORE:</b> Used for System/Personal Speed Dialling or storing programme changes.</p>	 	<p><b>PAUSE:</b> Used to insert a pause when storing a telephone number. This button also functions as the PROGRAM button when there is no PROGRAM button on your telephone.</p>
 	<p><b>REDIAL:</b> Used to redial the last dialled number.</p>	 	<p><b>MESSAGE:</b> Used to leave a message waiting indication or call back the party who left the message waiting indication.</p>

1.1 Before Operating the Telephones

	<p><b>INTERCOM:</b> Used to make or receive intercom calls.</p>		<p><b>Soft Buttons:</b> Used to select the item displayed on the bottom of the display.</p>
	<p><b>MONITOR:</b> Used for hands-free dialling. You can monitor the party's voice in hands-free mode.</p>		<p><b>AUTO ANS (Auto Answer)/MUTE:</b> Used to receive an incoming call in hands-free mode or mute the microphone during a conversation.</p>
	<p><b>TRANSFER:</b> Used to transfer a call to another party.</p>		<p><b>HOLD:</b> Used to place a call on hold.</p>

 	<p><b>FLASH/RECALL:</b> Used to disconnect the current call and make another call without hanging up. This button also functions as a CANCEL button while on-hook.</p>	 	<p><b>CONF (Conference):</b> Used to establish a multiple party conversation.</p>
 	<p><b>VOICE CALL/MUTE:</b> Used to monitor an intercom call automatically, but it cannot be used for hands-free conversations. It also mutes the handset microphone during a conversation.</p>	 	<p><b>Call Forwarding (FWD)/Do Not Disturb (DND):</b> Used to perform Call Forwarding (FWD) or Do Not Disturb (DND).</p>
    	<p><b>PROGRAM:</b> Used to enter and exit the Programming mode.</p>	 	<p><b>ANSWER:</b> Used to answer an incoming call.</p>

1.1 Before Operating the Telephones

 	<p><b>RELEASE:</b> Used to disconnect the line.</p>	     	<p><b>Navigator Key/Jog Dial/Volume Key:</b> Used to adjust the volume and the display contrast or select desired items.</p>
	<p><b>Programmable Feature (PF):</b> <i>Located on the upper part of the CO button array or on the DSS Console.</i> Assigns the desired button and used to access the stored feature. Mostly used as a One-touch Dialling button. (Only the "F and number" may be shown on some telephones.)</p>		<p><b>MODE:</b> Used to shift the display to access various features.</p>
	<p><b>SELECT:</b> Used to select the displayed item or to call the displayed phone number.</p>		<p><b>SHIFT:</b> Used to access the second level of Soft button features.</p>
	<p><b>ENTER:</b> Used to confirm the selected item.</p>		<p><b>CANCEL:</b> Used to cancel the selected item.</p>

**Customised Buttons**

If the term is in parentheses like (Account) in this section, it means a flexible button has been made into an "Account" button. To customise, refer to "3.1.3 Customising the Buttons".

Buttons	Feature
Loop-CO (L-CO)	Used to access an idle outside line for making outside calls. Incoming outside calls from any outside line arrive at this button.
Group-CO (G-CO)	Used to access an idle outside line in a specified outside line group for making outside calls. Incoming calls from outside lines in the assigned outside line group arrive at this button.

<b>Buttons</b>	<b>Feature</b>
Single-CO (S-CO)	Used to access a specified outside line for making or receiving outside calls.
Direct Station Selection (DSS)	Used to access an extension with one touch. It is also possible to be changed to the other feature button.
One-touch Dialling	Used to access a desired party or system feature with one touch.
Incoming Call Distribution Group (ICD Group)	Used to access a specified incoming call distribution group for making or receiving calls.
Message	Used to leave a message waiting indication or call back the party who left the message waiting indication.
Message for Another Extension	Used to have a Message button for another extension.
Call Forwarding (FWD)/Do Not Disturb (DND)—Both calls	Used to forward all calls to a specified destination or refuse.
FWD/DND—Outside calls	Used to forward outside calls to a specified destination or refuse.
FWD/DND—Intercom calls	Used to forward intercom calls to a specified destination or refuse.
Group FWD—Both calls	Used to forward all the calls to your group to a specified destination.
Group FWD—Outside calls	Used to forward the outside calls to your group to a specified destination.
Group FWD—Intercom calls	Used to forward the intercom calls to your group to a specified destination.
Account	Used to enter an account code.
Conference	Used to establish a multiple party conversation.
Terminate	Used to disconnect the current call and make another call without hanging up.
External Feature Access (EFA)	Used to access special features offered by a host PBX or a telephone company.
Call Charge Reference	Used to check the total call charge for your own extension.
Call Park	Used to park or retrieve a call in a preset parking zone.
Call Park (Automatic Park Zone)	Used to park a call in an idle parking zone automatically.
Call Log	Used to show the incoming call information.
Call Log for ICD Group	Used to have a Call Log button for incoming call distribution group.
Log-in/Log-out	Used to switch between the log-in and log-out mode.
Log-in/Log-out of a specified group	Used to have a Log-in/Log-out button for another incoming call distribution group.
Log-in/Log-out for all groups	Used to have a Log-in/Log-out button for all groups.
Hurry-up	Used to transfer the longest waiting call in the queue of an incoming call distribution group to the overflow destination.
Wrap-up	Used to switch the wrap-up status, Ready and Not Ready mode.
System Alarm	Used to confirm a PBX error.
Time Service (Day/Night/Lunch/Break)	Used to switch the time service mode.

## 1.1 Before Operating the Telephones

Buttons	Feature
Answer	Used to answer an incoming call.
Release	Used to disconnect the line during or after a conversation or to complete a Call Transfer.
Toll Restriction/Call Barring	Used to change the toll restriction/call barring level of other extension users temporarily.
ISDN Service	Used to access an ISDN service.
Calling Line Identification Restriction (CLIR)	Used to switch between the CLIP and CLIR services.
Connected Line Identification Restriction (COLR)	Used to switch between the COLP and COLR services.
ISDN-Hold	Used to transfer a call using telephone company.
Headset	Used to talk using the headset.
Time Service Switching Mode (Automatic/Manual)	Used to switch the time service mode, Automatic or Manual.
Two-way Record	Used to record a conversation into your own mailbox.
Two-way Transfer	Used to record a conversation into the mailbox of a specific extension.
One-touch Two-way Transfer	Used to record a conversation into the mailbox of a specific extension with one touch.
Live Call Screening (LCS)	Used to monitor your own voice mailbox while an incoming caller is leaving a message and, if desired, intercept the call.
Voice Mail Transfer	Used to transfer a call to the mailbox of a specified extension.
Network Direct Station Selection (NDSS)	Used to access an extension connected to other PBXs in the network with one touch.
CTI	Used to access CTI features.
Check-in	Used to switch the room status of extensions from Check-out to Check-in.
Check-out	Used to switch the room status of extensions from Check-in to Check-out.
Primary Directory Number (PDN)*	Used to make and receive both outside and intercom calls.
Secondary Directory Number (SDN)*	Used to show the current status of another extension, call the extension, and pick up or transfer calls to it.

\*: Only available for KX-TDA100/KX-TDA200/KX-TDA600.



### ◆◆ How to Follow the Steps

An example of system operation is shown below.

◆◆ **Calling Another Extension** Feature title

**To call an extension (Intercom Call)**

**PT/SLT/PS**

Off-hook.      Dial **extension number** or press **DSS**.      Talk.

Operation steps  
The description of the icons are explained on "Icon Descriptions".

- The DSS button light shows the current status as follows:
  - Off:** The extension is idle.
  - Red on:** Your or another extension is using the line.Conditions
- To call using a directory, refer to "1.11.2 Using the Directories".
- **For quick operation**  
If you are an operator or dial some extensions frequently, DSS buttons are useful.
- **Hands-free Operation**  
You can make an intercom call and have a conversation in hands-free mode using the SP-PHONE button.

**Customising Your Phone** Hints

- 3.1.2 Settings on the Programming Mode—**Preferred Line Assignment—Outgoing**  
Select the seized line when going off-hook.
- 3.1.3 Customising the Buttons  
Create or edit a Direct Station Selection (DSS) button.

**Programming References:** The related or required programming is noted.

### ◆◆ Connection Example

This diagram shows you a connection example.

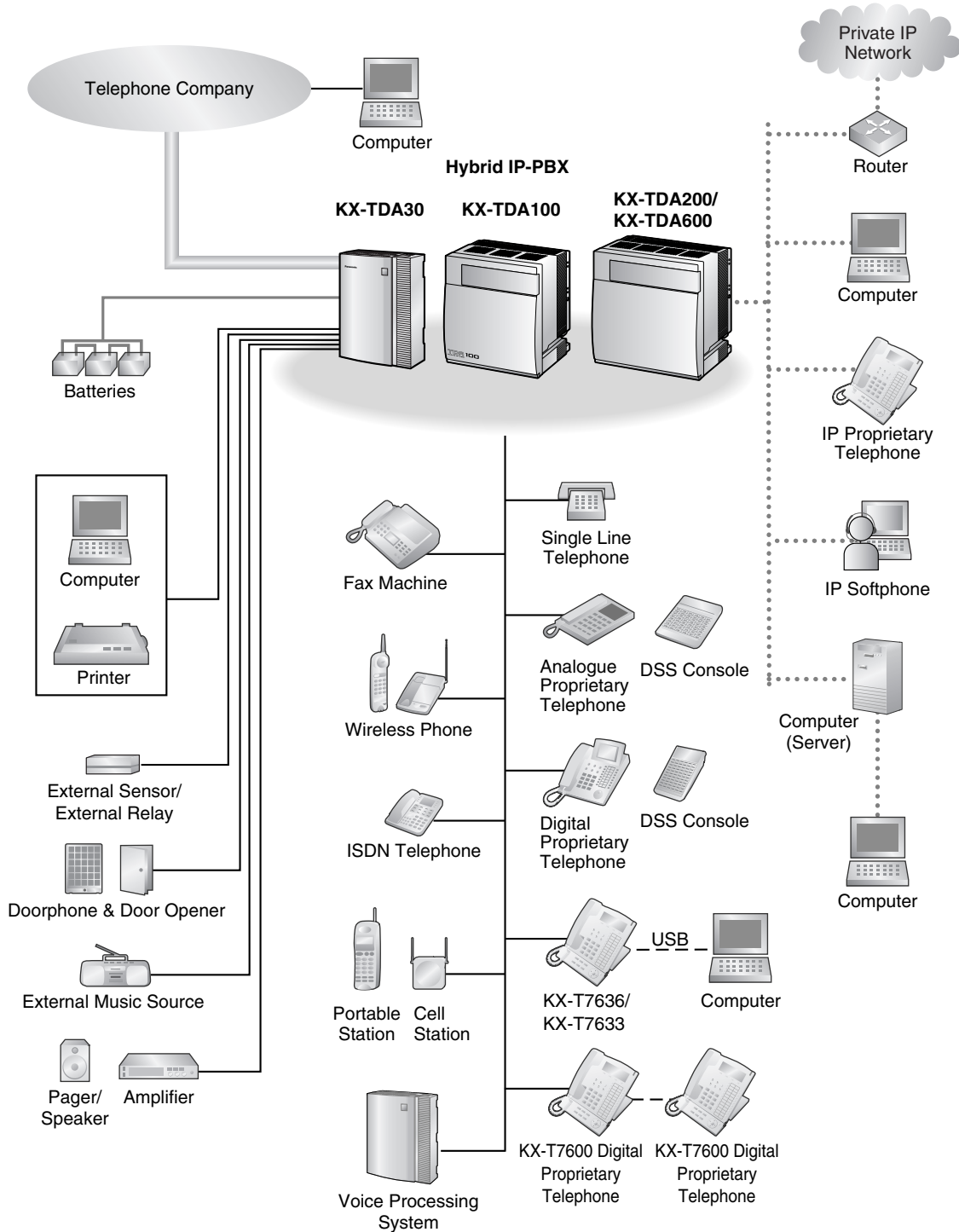

## 1.2 Making Calls

### 1.2.1 Basic Calling

- Calling Another Extension
- Calling an Outside Party
- Making a Call to a Private Network (TIE Line Access)
- Using an Account Code (Account Code Entry)

#### ◆◆ Calling Another Extension

To call an extension (Intercom Call)

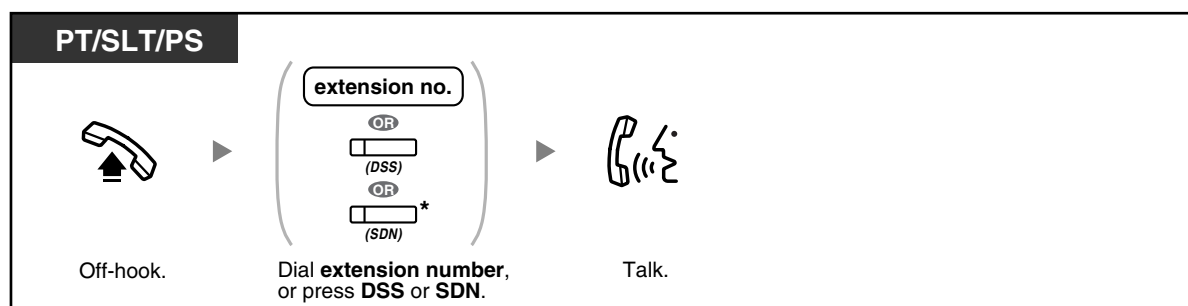

- The DSS button light shows the current status as follows:  
**Off:** The extension is idle.  
**Red on:** Your or another extension is using the line.
- \* You have to press the SDN button once or twice depending on the mode of the SDN button. For details, refer to "1.5.1 Primary Directory Number (PDN)/Secondary Directory Number (SDN) Extension (KX-TDA100/KX-TDA200/KX-TDA600 only)".



- To call using a directory, refer to "1.13.2 Using the Directories".
- **For quick operation**  
If you are an operator or dial some extensions frequently, DSS buttons are useful.
- **Hands-free Operation**  
You can make an intercom call and have a conversation in hands-free mode using the SP-PHONE button.



#### Customising Your Phone

- 3.1.2 Settings on the Programming Mode—**Preferred Line Assignment—Outgoing**  
Select the seized line when going off-hook.
- 3.1.3 Customising the Buttons  
Create or edit a Direct Station Selection (DSS) button.

### To call an operator (Operator Call)

You can call an extension or a group assigned as the operator.

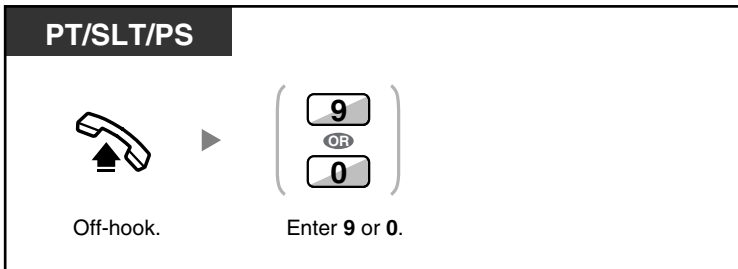

- The operator call number (default) varies depending on country/area.

### ◆◆ Calling an Outside Party

You have to seize an outside line before dialling an outside phone number because external calls are made via your PBX.

Select one of the following methods:

#### To select an idle outside line automatically (Automatic Line Access)

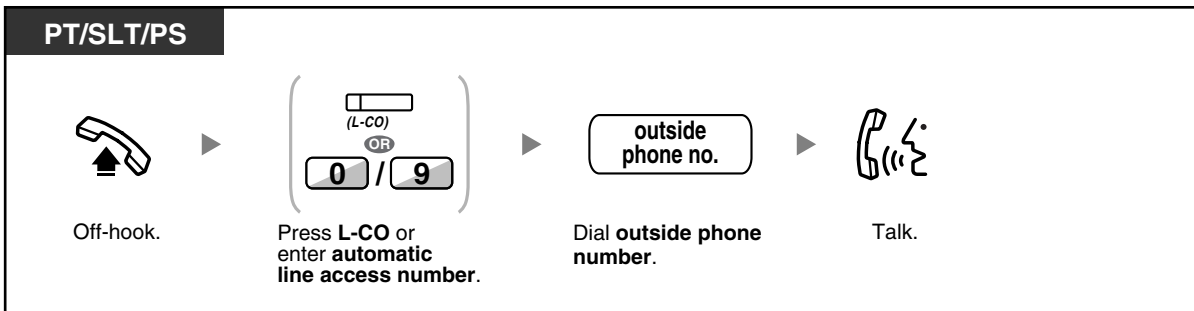

- The automatic line access number (default) varies depending on country/area.

#### To select an idle outside line in the specified outside line group automatically (Outside Line Group Access)

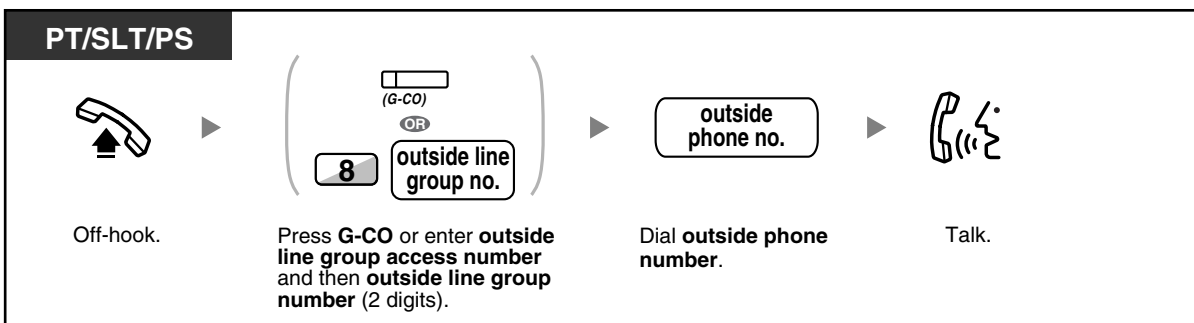

## To select the specified outside line

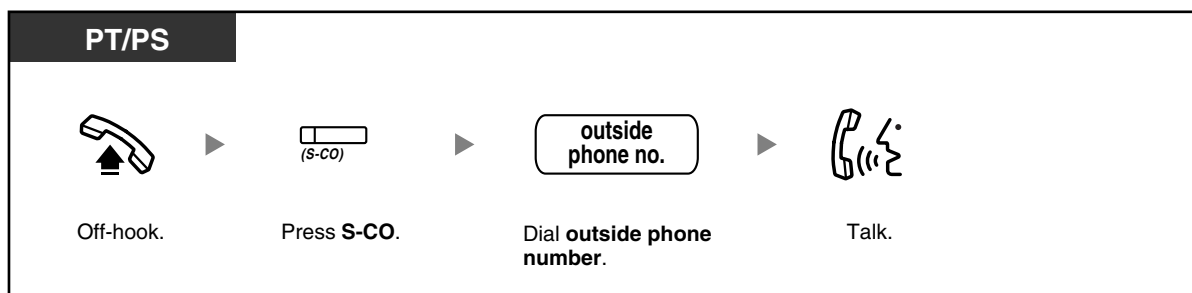

- Each of the S-CO button or G-CO button light shows the current status as follows:

**Off:** The line is idle.

**Red on:** The line is in use.

- You may be restricted from making a call to the specified outside party. To make a call, refer to "1.2.7 Calling without Restrictions".



- To confirm number before dialling**, you can enter a phone number and confirm it on the display and then go off-hook. (Predialling)
- Call Charge Reference**  
You can confirm your total call charges by pressing the Call Charge Reference button.
- To make a call to another party without going on-hook**, press the FLASH/RECALL button. It will re-access the outside line and provide external dial tone. Pressing the Terminate button will provide intercom dial tone. You can dial the new phone number without going on/off-hook.
- Hands-free Operation**  
You can make an outside call and have a conversation in hands-free mode using the SP-PHONE button.



### Customising Your Phone

- 3.1.2 Settings on the Programming Mode—**Preferred Line Assignment—Outgoing**  
Select the seized line when going off-hook.
- 3.1.3 Customising the Buttons  
Create or edit a Loop-CO (L-CO) button, a Group-CO (G-CO) button, a Single-CO (S-CO) button, a Terminate button or a Call Charge Reference button.

## ◆◆ Making a Call to a Private Network (TIE Line Access)

You can access extensions connected to other PBXs in a private network.

### To call

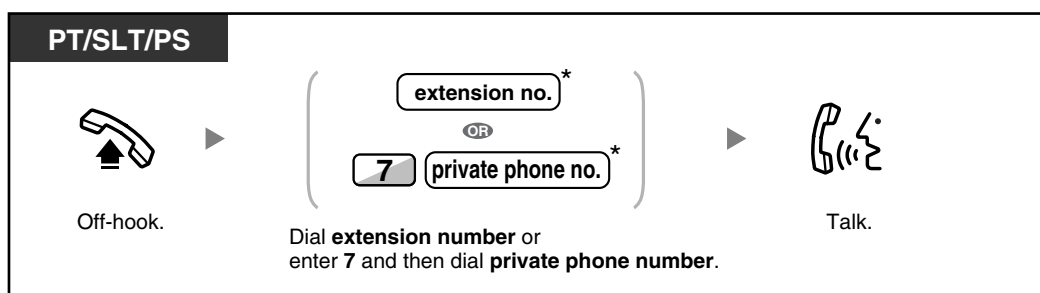

## 1.2 Making Calls



- \* Which type of telephone number must be entered depends on the settings of your PBX.

### To call with one touch



- To start monitoring another PBX extension after customising an NDSS button,** go off-hook, press the NDSS button, and go on-hook. The NDSS button light will show the current status as follows:  
**Off:** The extension is idle.  
**Red on:** The extension is busy.



### Customising Your Phone

- 3.1.3 Customising the Buttons  
 Create or edit a Network Direct Station Selection (NDSS) button.

## ◆◆ Using an Account Code (Account Code Entry)

You may give a specified account code to extension users and check their telephone usage. You can specify an account code for each client and check the call duration.

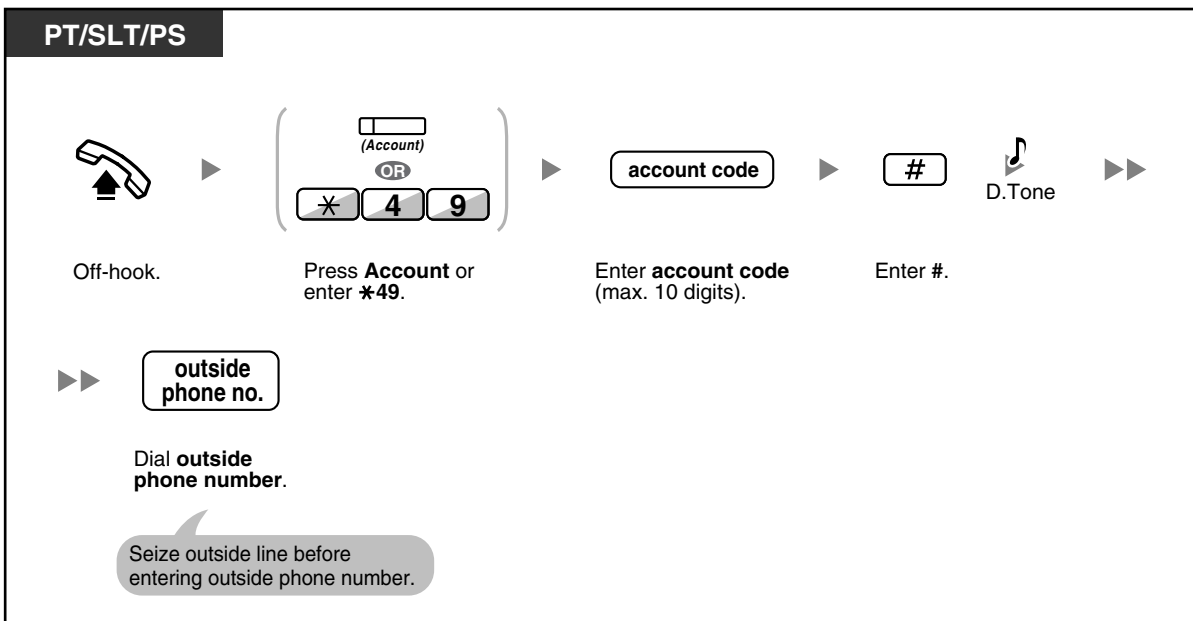



- **A Panasonic proprietary telephone extension user** can enter an account code during a conversation and when hearing reorder tone after the other party hangs up.
- Account codes may use the digits "0" through "9".
- Depending on the settings of your PBX, you may be required to enter an account code to make an outside call.
- **If you enter the wrong code**, press the "\*" key and re-enter the account code.



- **For your convenience**, you can store the code with the phone number in the memory (e.g., Speed Dialling).



### Customising Your Phone

- 3.1.3 Customising the Buttons  
Create or edit an Account button.



## 1.2.2 Easy Dialling

This is convenient for frequently dialled phone numbers.

- With a One-touch Button (One-touch Dialling)
- Using Numbers Stored at Your Extension (Personal Speed Dialling)
- Using Numbers Stored in the PBX (System Speed Dialling)
- To a Preset Number by Going Off-hook (Hot Line)
- Using a Preprogrammed Number (Quick Dialling)

### ◆◆ With a One-touch Button (One-touch Dialling)

You can store a phone number into the flexible button for one-touch operation.

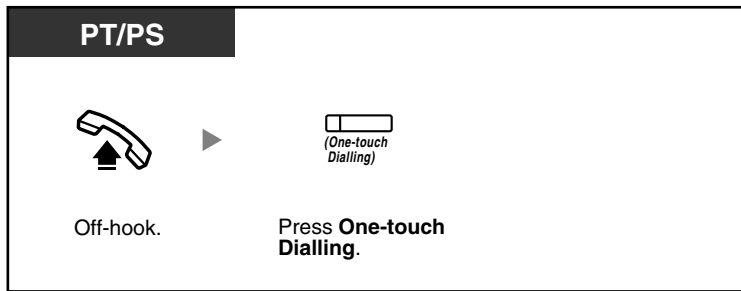

#### Customising Your Phone

- 3.1.3 Customising the Buttons  
Create or edit a One-touch Dialling button, store the desired phone number or feature number.

### ◆◆ Using Numbers Stored at Your Extension (Personal Speed Dialling)

You can store numbers at your extension for your personal use.  
This feature is also known as Station Speed Dialling.

#### To store a phone number

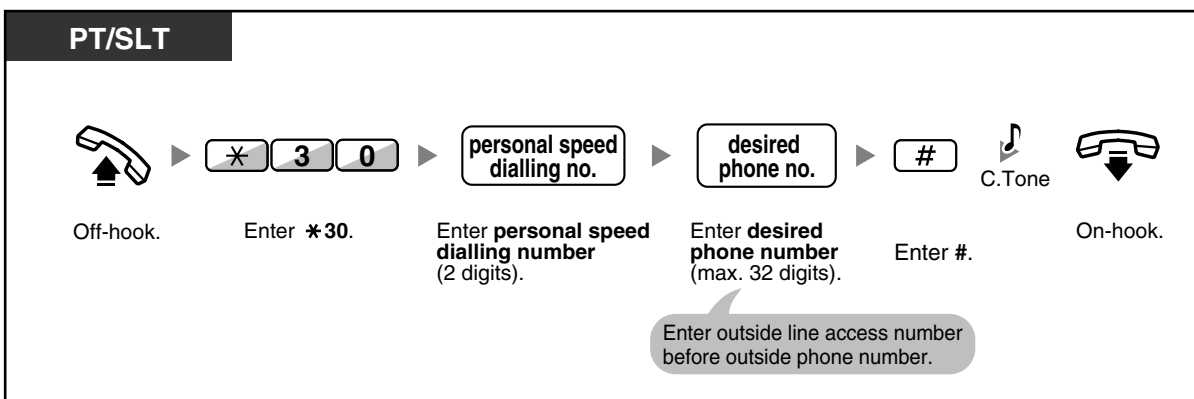



- The number of personal speed dialling numbers available per extension (default: 10 numbers stored in locations "00" to "09") can be increased to a maximum of 100.

### To dial

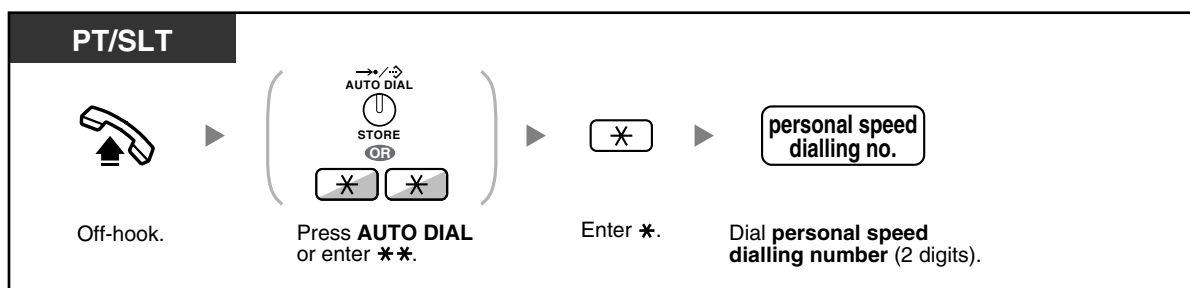

- To call using a directory, refer to "1.13.2 Using the Directories".

### ◆◆ Using Numbers Stored in the PBX (System Speed Dialling)

You can make calls using speed dialling numbers stored in the PBX.

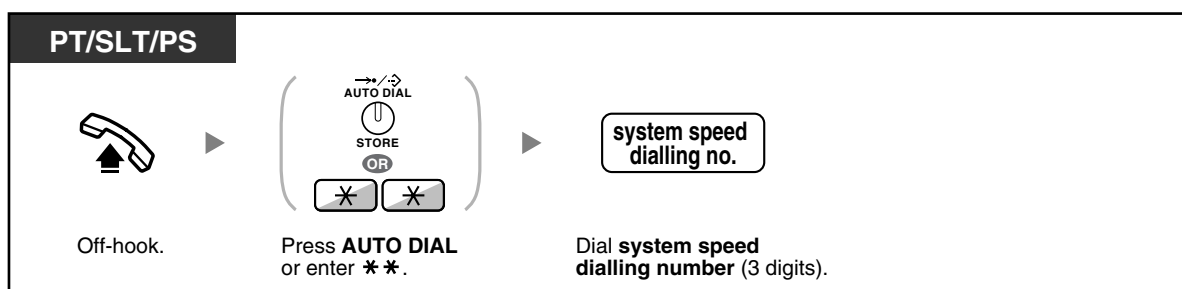

- To call using a directory, refer to "1.13.2 Using the Directories".

### ◆◆ To a Preset Number by Going Off-hook (Hot Line)

You can make an outside call simply by going off-hook if you have preprogrammed your phone. This feature is also known as Pickup Dialling.

#### To store a phone number

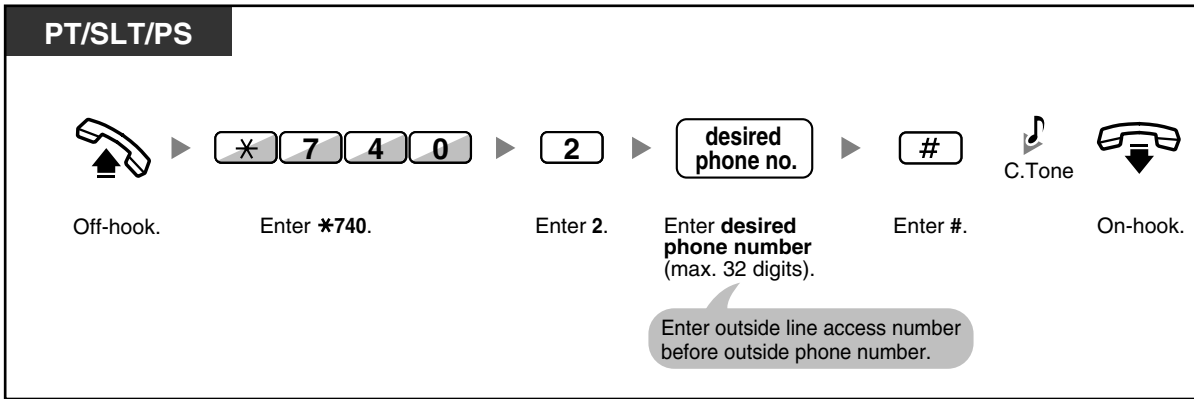

#### To set/cancel

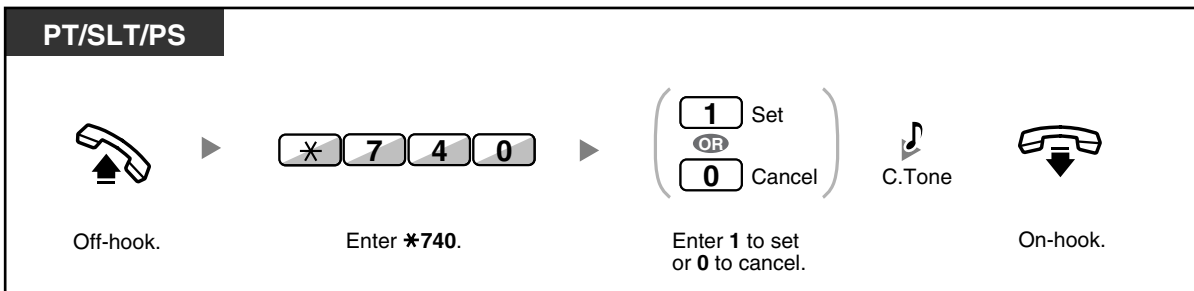

#### To dial



- **To call another party**, dial the desired party's phone number before the preprogrammed number is dialled.
- You should assign the intercom line as the seized line when going off-hook. (Preferred Line Assignment—Outgoing)
- It is possible to increase the delay before Hot Line is activated through system programming. This can be useful if you require more time after going off-hook to dial another telephone number or extension number.



### Customising Your Phone

- 3.1.2 Settings on the Programming Mode—**Preferred Line Assignment—Outgoing**  
Select the seized line when going off-hook.

## ◆◆ Using a Preprogrammed Number (Quick Dialling)

You can make a call simply by pressing the preprogrammed number for quick dialling.

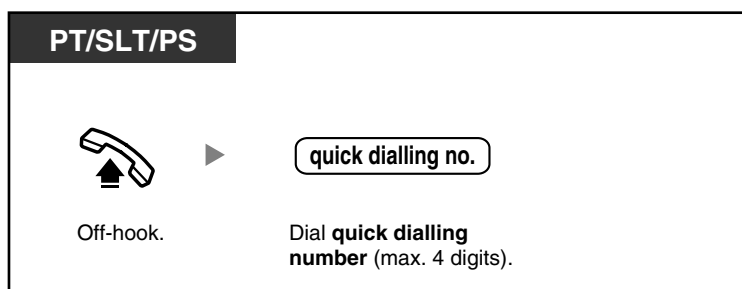

- The length of a quick dialling number can be increased to a maximum of eight digits.
- This is a useful feature for hotels.  
For example, to dial Room Service, dial the digit "3", not the full extension number.

## 1.2.3 Redial

This is convenient when calling the same outside party again.

- Redialling the Last Number You Dialed (Last Number Redial)

### ◆◆ Redialling the Last Number You Dialed (Last Number Redial)

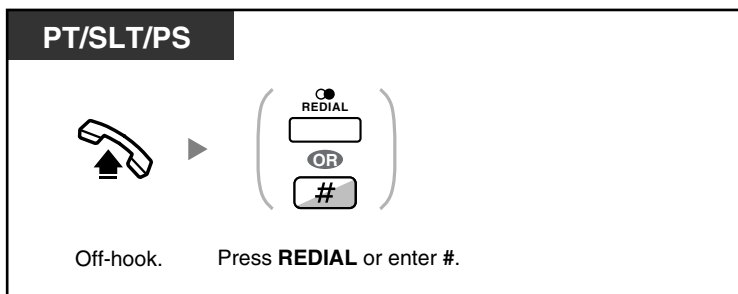

- Up to 32 digits can be stored and redialled.
- After pressing REDIAL, if you hear a busy tone again, press REDIAL to retry.



- **Automatic Redial**

**To redial automatically**, press the SP-PHONE button and then the REDIAL button, or press the REDIAL button directly. It will keep trying the busy number until the called party answers or until a specified timeout.

You can perform other tasks during dialling. To cancel, press the FLASH/RECALL button. Some outside lines may not support this feature.

This feature is not available for the KX-T7665 and PS.

## 1.2.4 When the Dialed Line is Busy or There is No Answer

- Reserving a Busy Line (Automatic Callback Busy)
- Setting Callback on an ISDN Line (Completion of Calls to Busy Subscriber [CCBS])
- Sending a Call Waiting Notification (Call Waiting)
- Leaving a Message Waiting Indication/Calling Back the Caller Who Left an Indication (Message Waiting)
- Joining an Existing Call (Executive Busy Override)
- Monitoring Another Extension (Call Monitor)
- To an Extension Refusing the Call (DND Override)

### ◆◆ Reserving a Busy Line (Automatic Callback Busy)

You can set the telephone to receive callback ringing:

- when a dialed extension becomes idle.
- when your desired outside line that is in use by another extension becomes idle.

You cannot set Automatic Callback Busy for a busy party outside of the PBX.

When you answer the callback ringing:

- For an outside call: The line is seized.
- For an intercom call: The called extension starts ringing automatically.

#### To set (for both extension and outside line)

**PT/SLT/PS**

*While hearing a busy tone*



Enter 6.



C.Tone



On-hook.

#### To answer the callback ringing from an idle extension

**PT/SLT/PS**

*While hearing a callback ringing*



Off-hook.



R.B.Tone



Talk.

**To answer the callback ringing from an idle outside line**

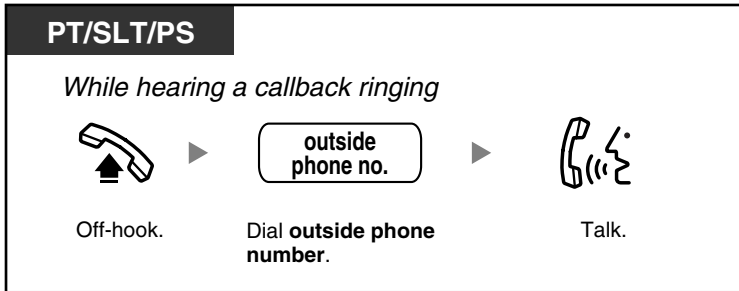

- If you do not answer the callback ringing within 10 seconds, this feature will be cancelled.

**To cancel callback ringing (Automatic Callback Busy Cancel)**

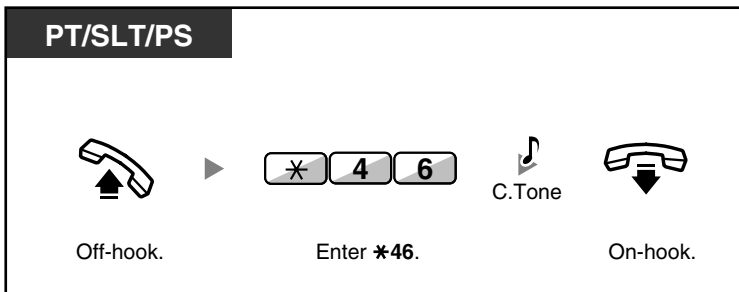

**◆◆ Setting Callback on an ISDN Line (Completion of Calls to Busy Subscriber [CCBS])**

You can set the telephone to receive callback ringing when a busy called party on an ISDN line becomes free.

When you answer the callback ringing, the called party's telephone number is automatically dialled.

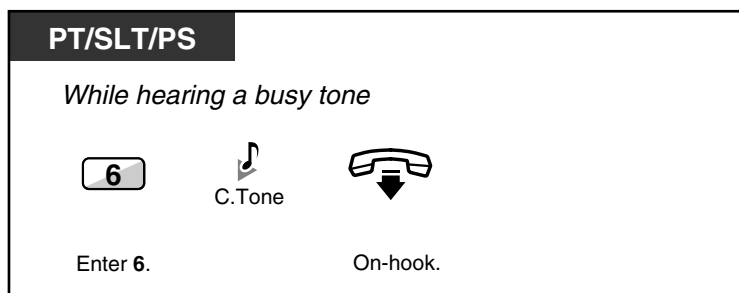



### To answer while hearing a callback ringing



### To cancel (CCBS Cancel)

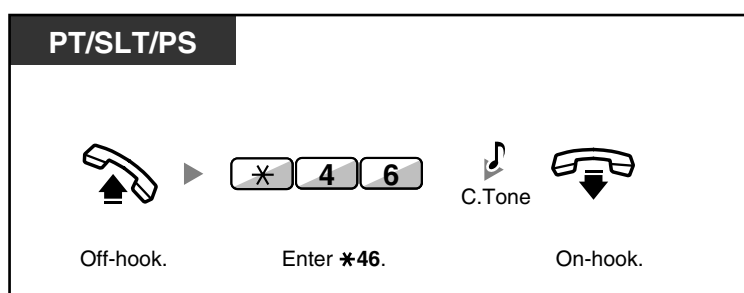

- If you do not answer within a specified time period, this feature will be cancelled.
- Availability of this feature depends on the ISDN service of your telephone company.

## ◆◆ Sending a Call Waiting Notification (Call Waiting)

You can inform the called party that your call is waiting.  
This feature is also known as Busy Station Signalling (BSS).

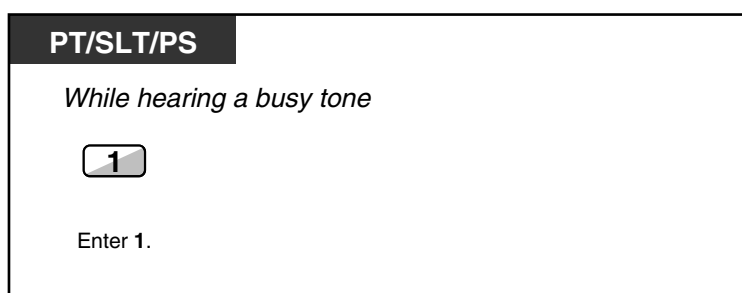

- **Depending on the type of the other party's telephone**, you may be able to talk to the other party using the speaker and the microphone (Off-hook Call Announcement [OHCA]), or you can send a call announcement through the handset (Whisper OHCA), if they are having another conversation using the handset.  
Refer to "1.8.3 Receiving Call Waiting (Call Waiting/Off-hook Call Announcement [OHCA]/Whisper OHCA)".
- Depending on system programming and the called extension's setting, a call waiting tone may be sent automatically without performing the operation above. For details, refer to "**Automatic Call Waiting**" in Section "3.1.2 Settings on the Programming Mode".

## ◆◆ Leaving a Message Waiting Indication/Calling Back the Caller Who Left an Indication (Message Waiting)

### ◆ For a caller

When the called extension is busy or does not answer your call, you can leave a notification so that the called party may call you back.

### ◆ For a called extension

As a message receiver, the Message button light or Message/Ringer Lamp lets you know that a call has been received. If you receive notification, you can call the caller back by a simple operation.

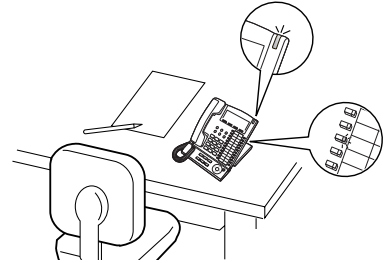

### ◆ For a caller

#### To leave a message waiting indication

**PT/SLT/PS**

*When the called extension is busy or does not answer*



Press **MESSAGE**  
or enter **4**.



C.Tone



On-hook.

#### To leave/cancel a message waiting indication

**PT/SLT/PS**



Off-hook.

Enter **\*70**.

**1** Leave  
**OR**  
**0** Cancel

Enter **1** to leave  
or **0** to cancel.

**desired extension no.**

Enter **desired extension number**.



C.Tone



On-hook.

◆ For a called extension

To check the left message and call back

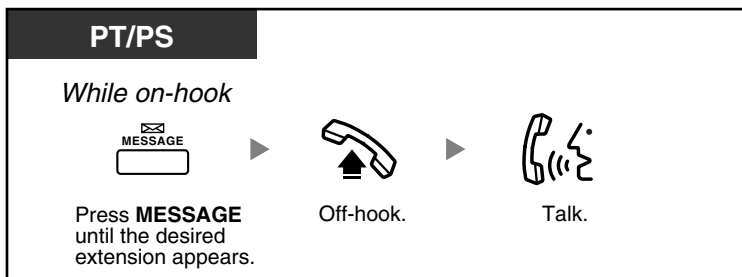

To call back

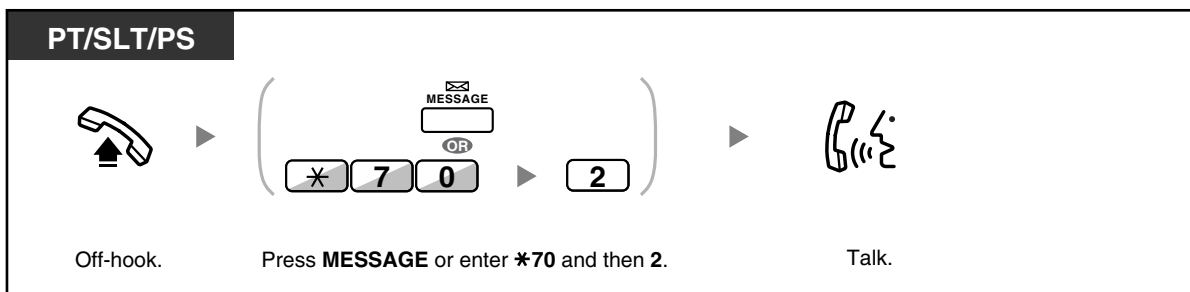

To clear message waiting indications left on your extension

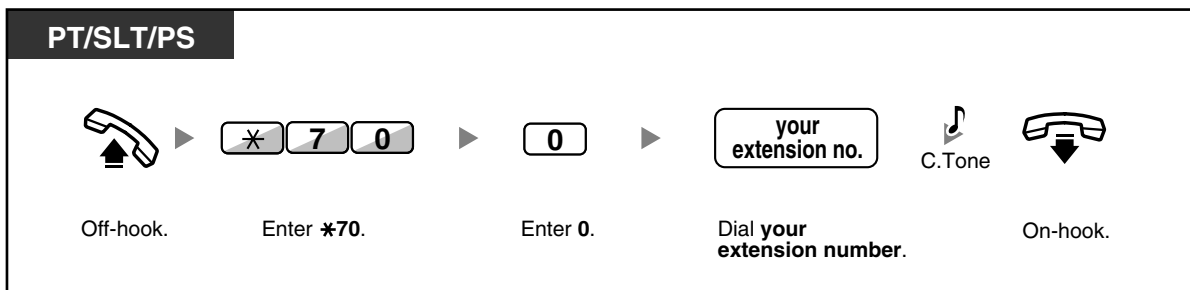

## 1.2 Making Calls



- The Message button light or Message/Ringer Lamp shows the current status as follows:
  - Off:** No message
  - Red on:** You have a message.
- The display shows the messages starting with the most recent call.
- At a called extension, the MESSAGE button allows you to clear message waiting indications if you do not want to call the callers back. To clear, press the MESSAGE button and then press the soft button.
- On your PT, you can establish one or more Message for Another Extension buttons. These buttons can accept the message waiting notification of other extensions or various incoming call distribution groups. In other words, you can monitor the message waiting notifications of other telephones.
- A single line telephone extension user will receive a special dial tone as message waiting notification when going off-hook.
- KX-TDA100/KX-TDA200/KX-TDA600 only**  
The message waiting lamp of a single line telephone can also let you know that you have a message in the same way as the Message button.



### Customising Your Phone

- 3.1.3 Customising the Buttons  
Create or edit a Message button or Message for Another Extension button.

## ◆◆ Joining an Existing Call (Executive Busy Override)

The preprogrammed extension can call someone who is busy on the telephone and establish a three-party conversation.

### To join an intercom call

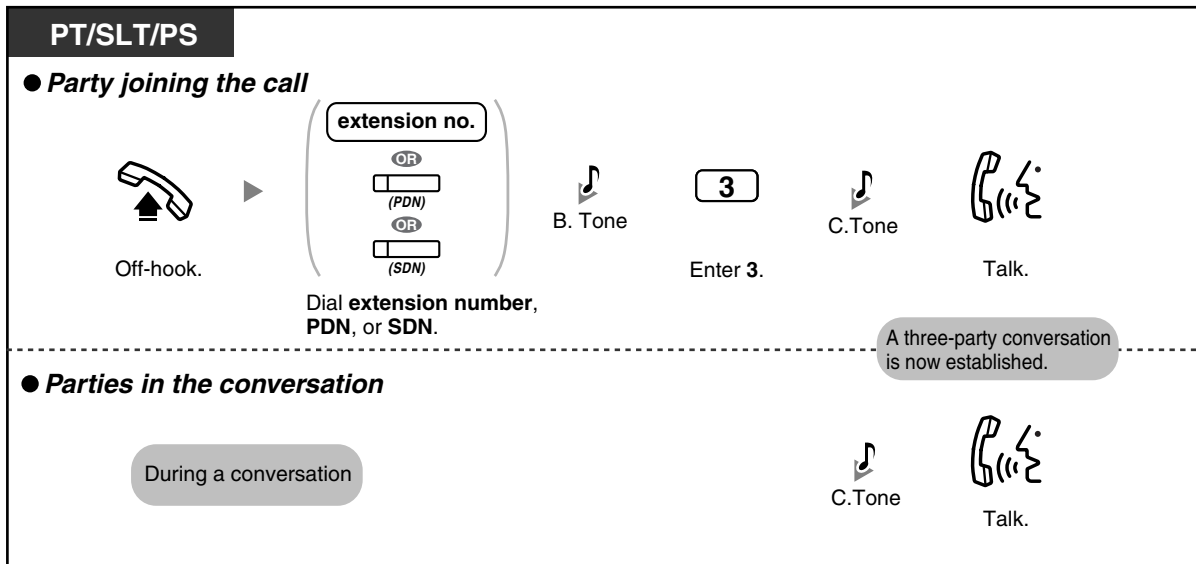

### To join an outside call

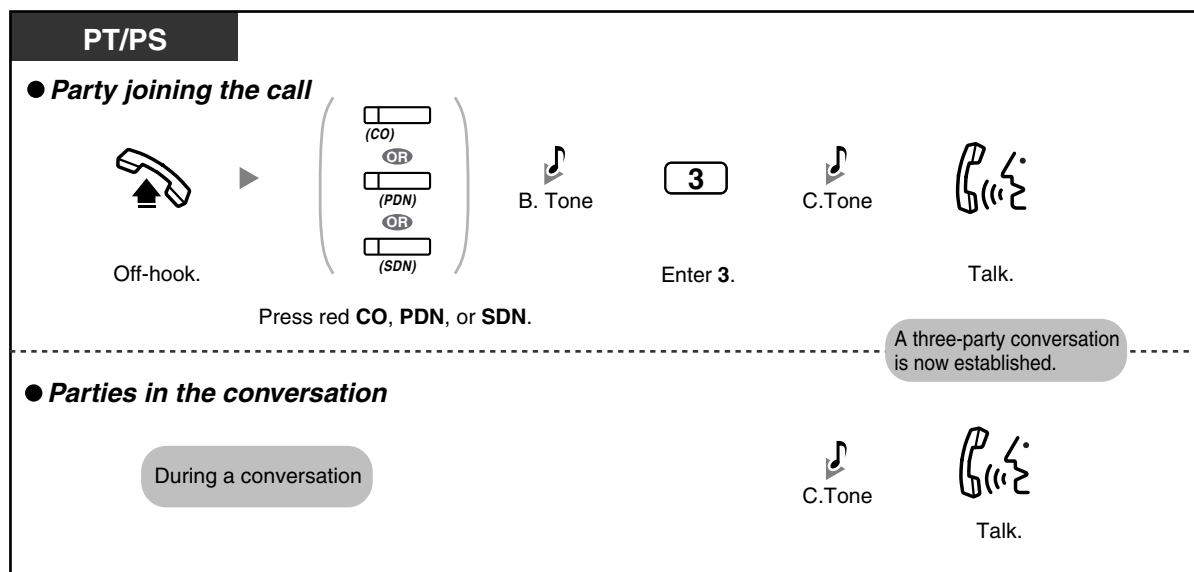

- To join another conversation, you must have Executive Busy Override enabled at your extension through COS programming.
- It is possible for an originating extension to leave a three-party conversation with an outside party and let the two other parties talk by simply going on-hook.

### ◆ For the originating extension

#### To talk to each party alternately

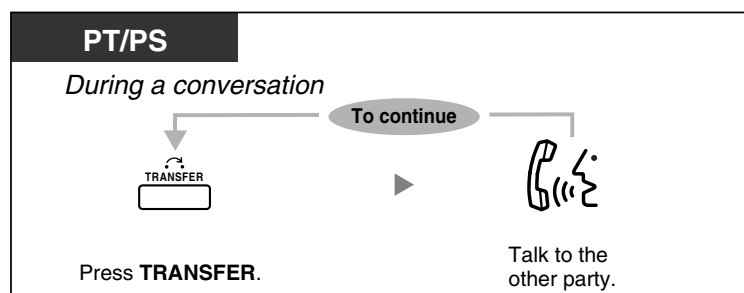

- You can also deny others the possibility of joining your conversation (Default: Allow). Refer to "1.8.7 Preventing Other People from Joining Your Conversation (Executive Busy Override Deny)".

### ◆◆ Monitoring Another Extension (Call Monitor)

The preprogrammed extension can monitor another extension.

#### To monitor

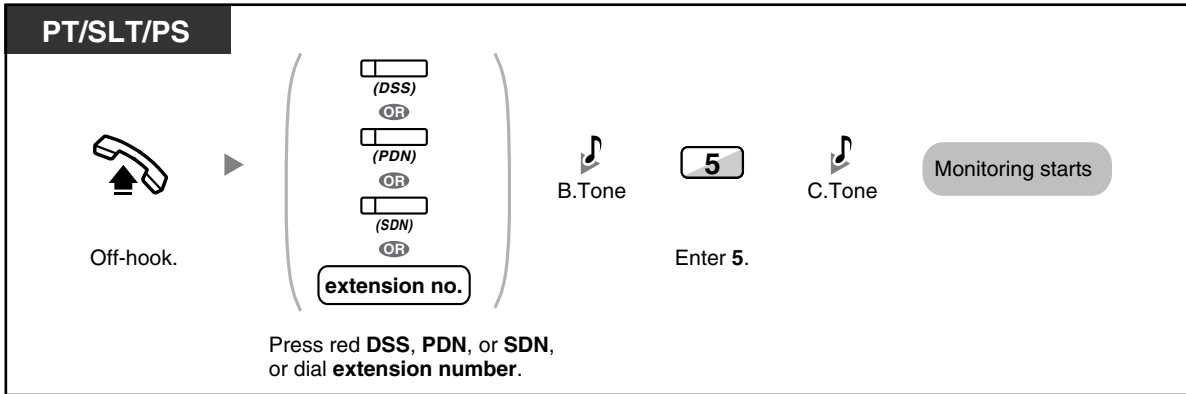

### ◆◆ To an Extension Refusing the Call (DND Override)

The preprogrammed extension can call someone who has set the DND feature.

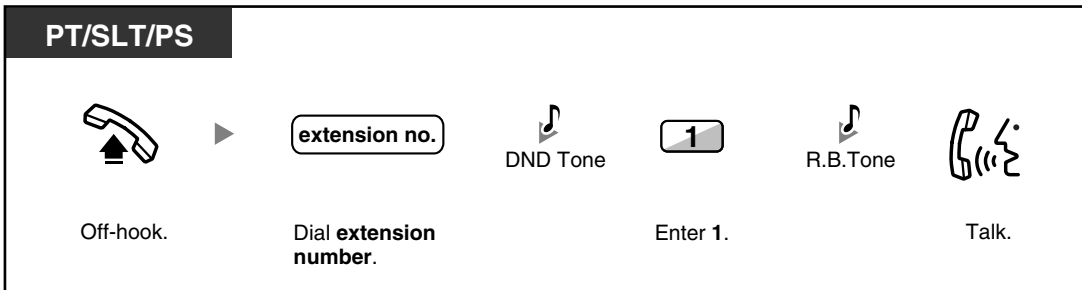

## 1.2.5 Accessing the ISDN Service (ISDN Service Access)

You can access services provided by the ISDN.



### To access

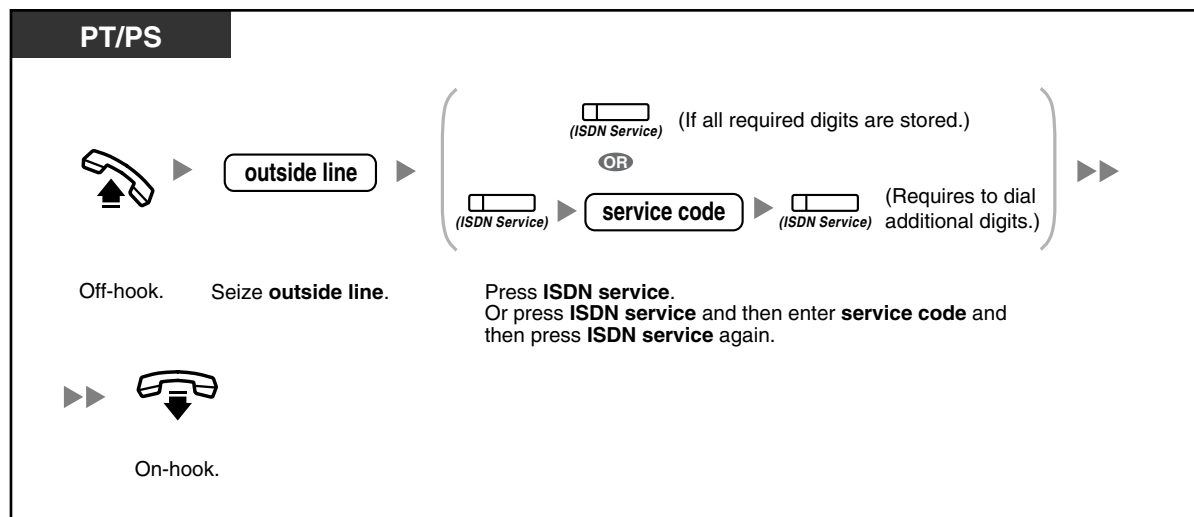

- Availability of features depends on the ISDN service of your telephone company.



### Customising Your Phone

- 3.1.3 Customising the Buttons  
Create or edit an ISDN Service button.

## 1.2.6 Alternating the Calling Method (Alternate Calling—Ring/Voice)



The caller can alternate the alerting method, either ring or voice, when making an intercom call. On the other hand, any extension can set the alerting method, either ring or voice, when receiving an intercom call.

**Ringing (Default):** You can call the other party with a ring tone.

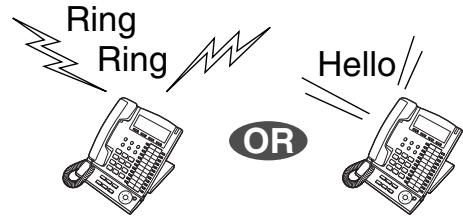
**Voice-calling:** You can talk to the other party immediately after confirmation tone.



### To change the method

PT/SLT/PS		
<i>After dialling</i>		
		
Enter *.		Talk.

-  If the called party uses a single line telephone or portable station, Voice-calling is not available.
- This feature is not available when the called party's telephone is in the Voice Call Deny mode.

### Customising Your Phone

- 3.1.2 Settings on the Programming Mode—**Alternate Receiving—Ring/Voice**  
Select the alerting method, either ring or the other party's voice.



## 1.2.7 Calling without Restrictions

- Using Your Calling Privileges at Another Extension (Remote COS Access)

### ◆◆ Using Your Calling Privileges at Another Extension (Remote COS Access)

You can use your calling privileges (Class of Service) at another extension. You may override restrictions which have been set. To use this feature, an original extension number and an extension PIN (Personal Identification Number) are required. You can make a call by entering a verification code and verification code PIN.

#### To call (Walking COS)

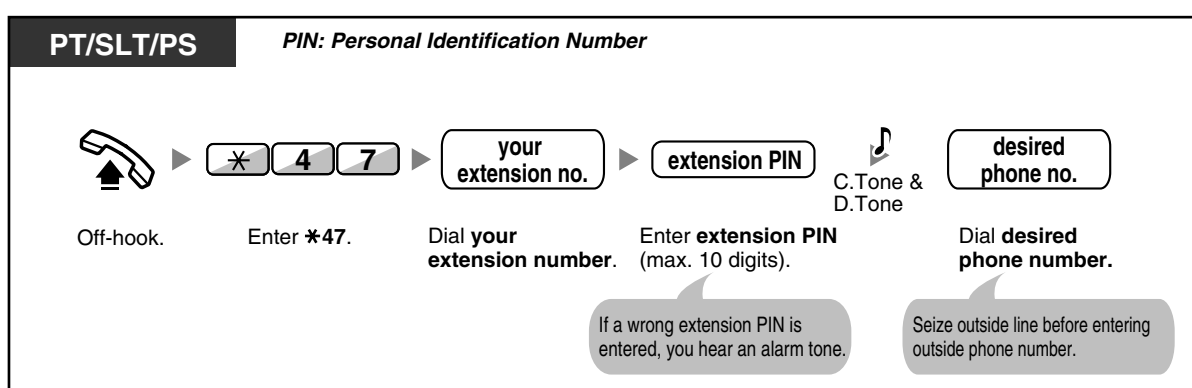

#### To call with a verification code (Verification Code Entry)

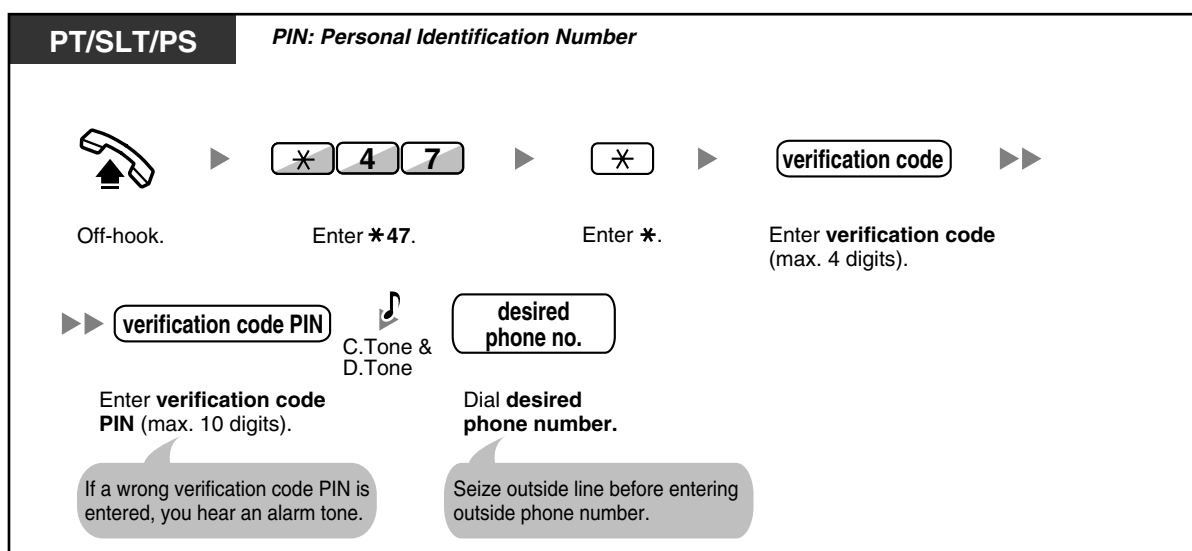

## 1.2.8 To Access Another Party Directly from Outside (Direct Inward System Access [DISA])

- Calling through DISA

### ◆◆ Calling through DISA

When outside callers access extensions in the PBX, a prerecorded message greets the caller and gives information about how to access an extension. You do not need the operator's assistance.

You may be able to access system features or call an outside party with your password depending on the security mode.

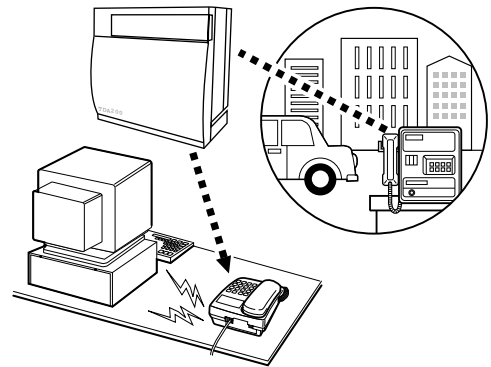

#### To call an extension

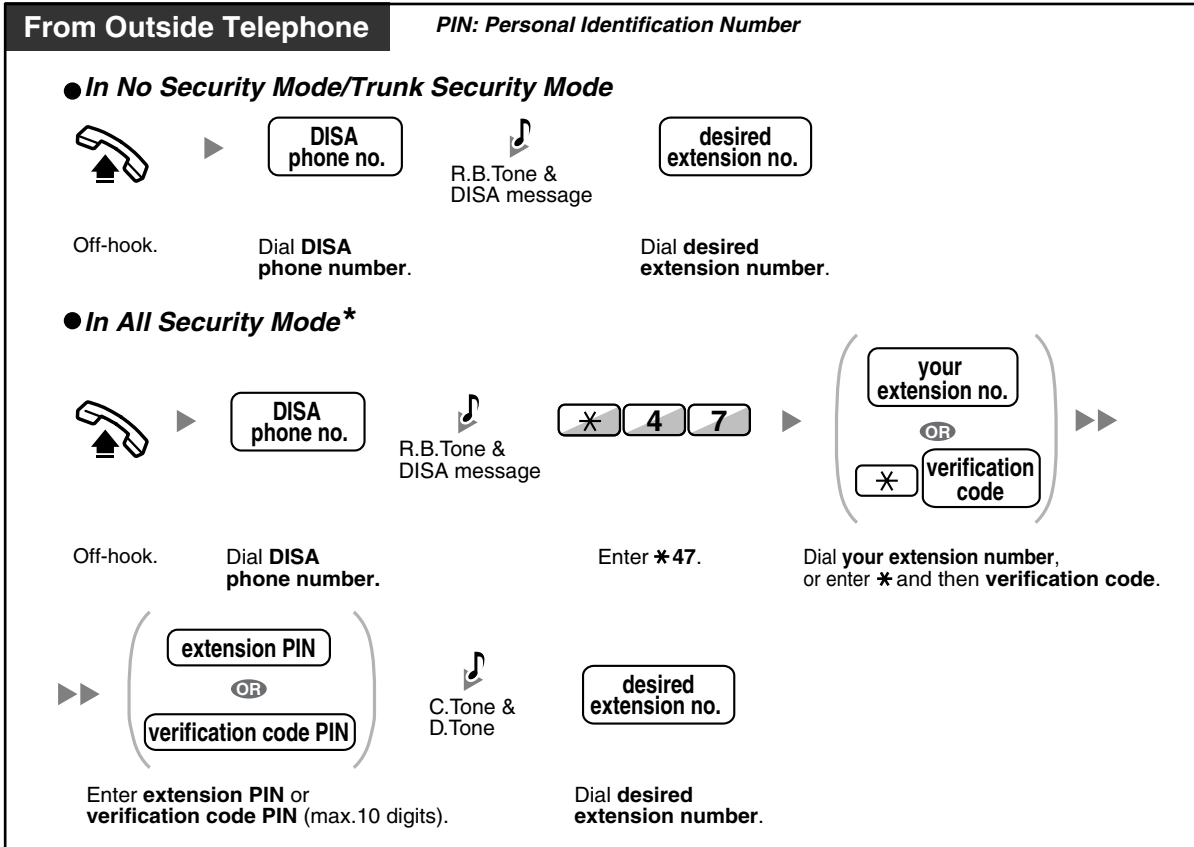

### To call an outside party

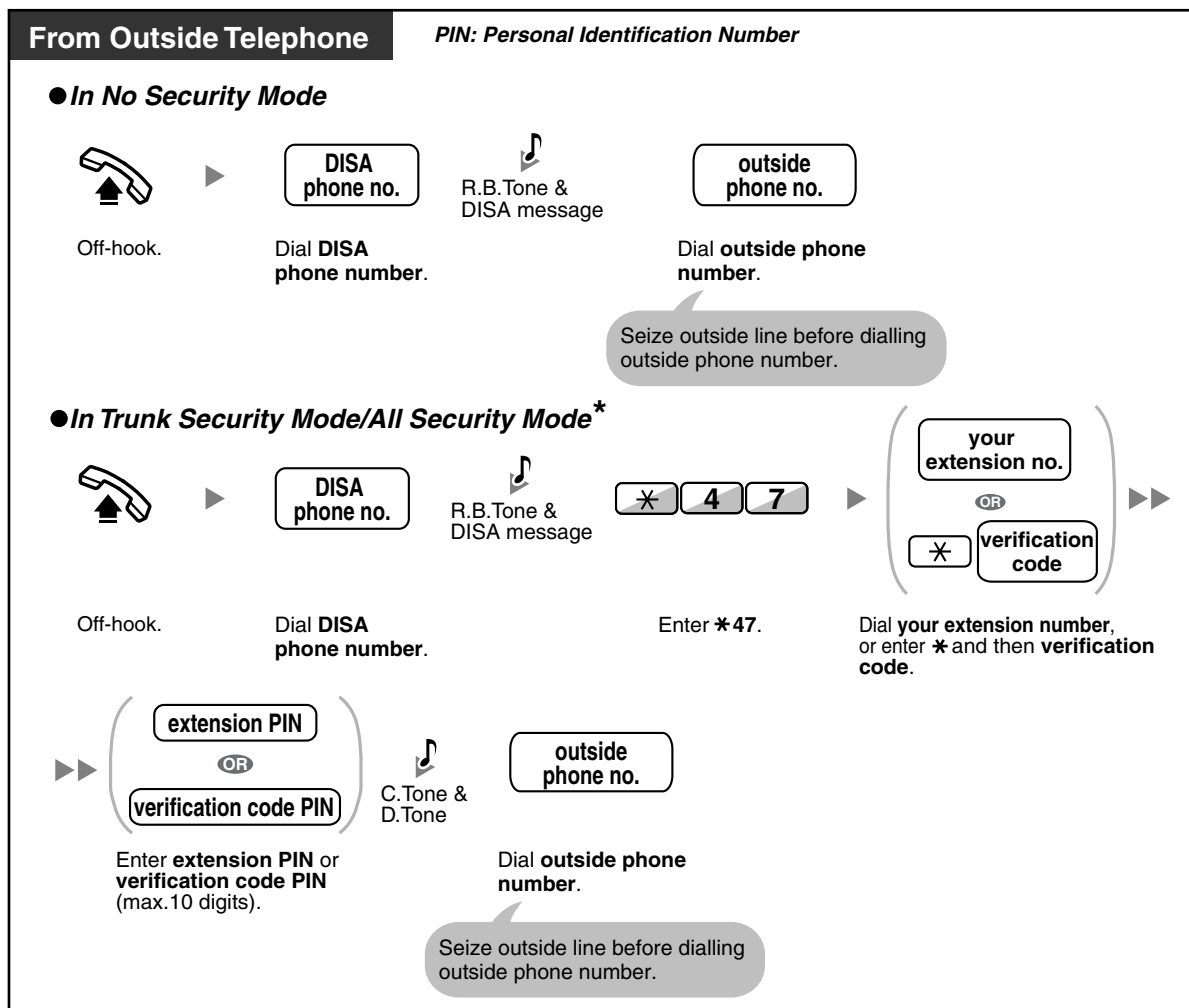

- \* Callers from preprogrammed outside numbers can access the PBX through DISA without a password (extension PIN/verification code PIN) (**DISA Automatic Walking COS**).

### To retry

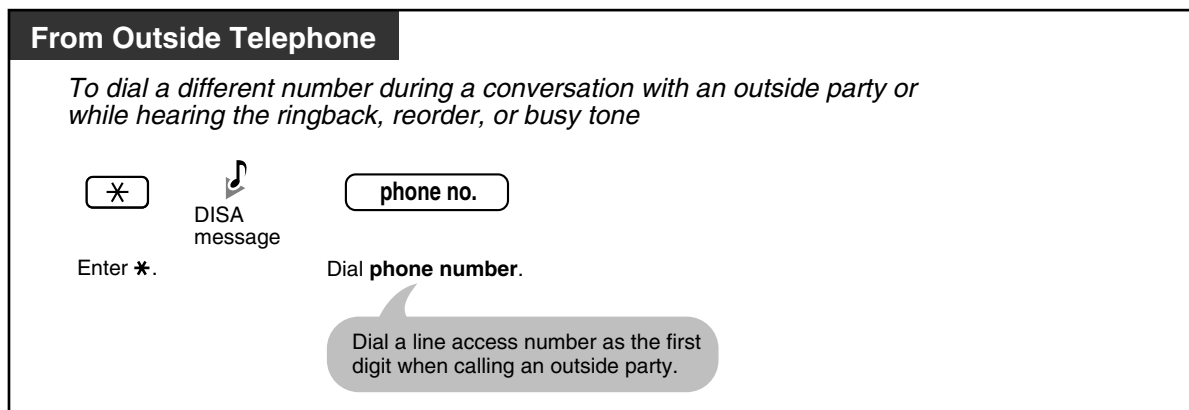



- **WARNING**  
There is a risk that fraudulent telephone calls will be made using the Outside-to-Outside Call feature of DISA.  
The cost of such calls will be billed to the owner/renter of the PBX.  
To protect the PBX from this kind of fraudulent use, we strongly recommend:
  - a) Enabling DISA security (Trunk Security or All Security).
  - b) Keeping your passwords (verification code PIN/extension PIN) secret.
  - c) Selecting complex, random PINs that cannot be easily guessed.
  - d) Changing PINs regularly.
- **Time limit**  
Both parties will hear an alarm tone fifteen seconds before the specified time limit. To extend, press any dial button except \*.
- **If Built-in Automated Attendant service is set**, you can access the desired extension simply by pressing a single digit (0–9) from the options given the prerecorded message.

## 1.2.9 Setting Your Telephone from Another Extension or through DISA (Remote Setting)

You can set the following features on your telephone from another extension or through DISA.

- Call Forwarding (FWD)/Do Not Disturb (DND)
- Changing the Log-in/Log-out Status of Extensions
- Absent Message
- Extension Dial Lock
- Time Service—Changing the Time Mode (Day/Night/Lunch/Break)

### From another extension

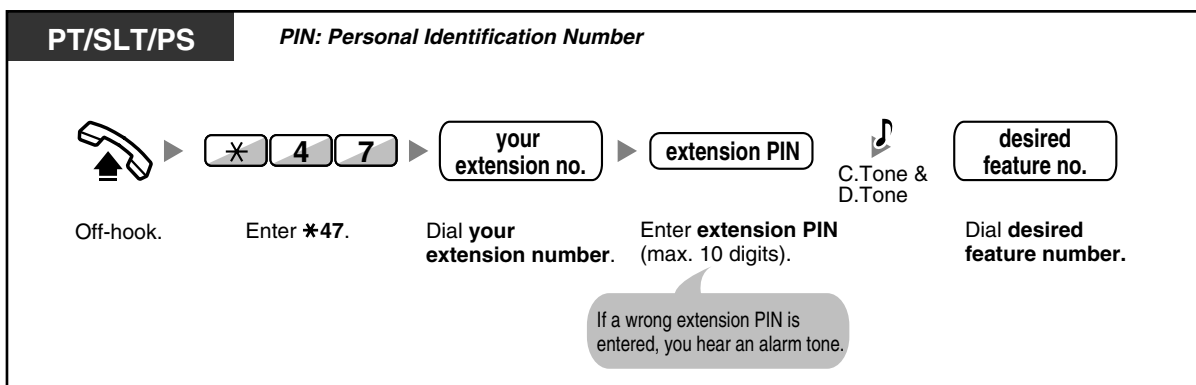

### Through DISA

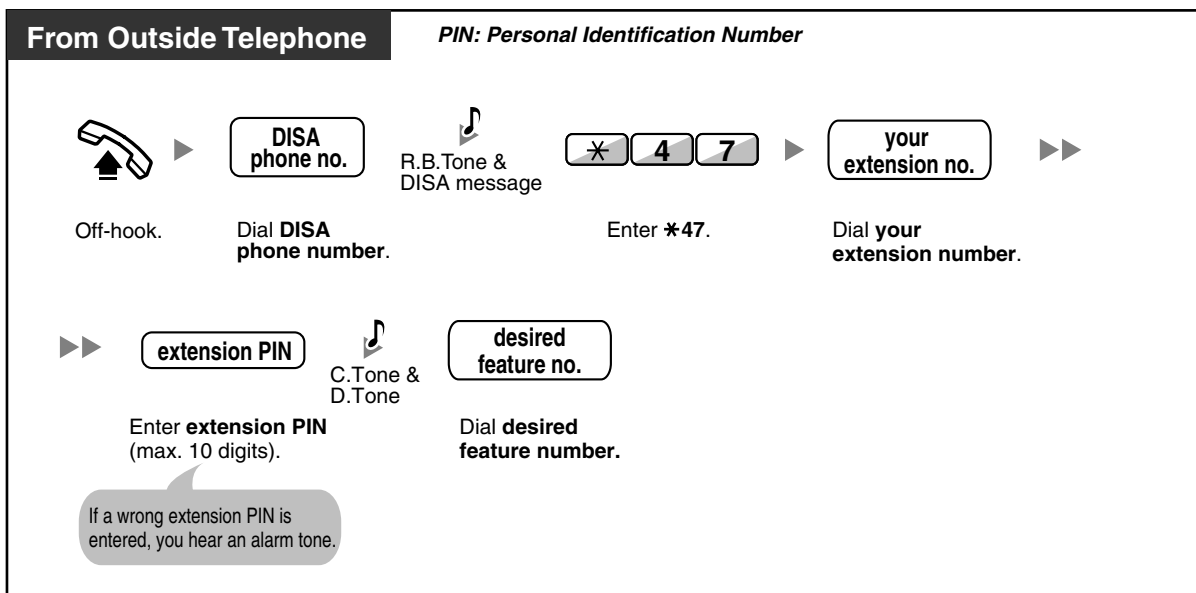

## 1.3 Receiving Calls

### 1.3.1 Answering Calls

**PT/SLT/PS**



Off-hook.      Talk.

Select one of the following methods:

- Lift the handset to receive the preferred line.  
(Default: Ringing line is selected.)
- Press the SP-PHONE button.
- Press the flashing CO, INTERCOM, ICD Group, PDN, or SDN button directly.
- Press the ANSWER button.



- **Hands-free Operation**

You can receive a call and have a conversation in hands-free mode using the SP-PHONE button.



- **Customising Your Phone**

- 3.1.2 Settings on the Programming Mode—

- **Preferred Line Assignment—Incoming**

- Select the seized line when going off-hook.

- **Alternate Receiving—Ring/Voice**

- Select the alerting method, either ring or the other party's voice.

- 3.1.3 Customising the Buttons

- Create or edit an Incoming Call Distribution Group (ICD Group), Primary Directory Number (PDN), or Secondary Directory Number (SDN) button.

## 1.3.2 Answering Hands-free (Hands-free Answerback)

You can answer an incoming call without going off-hook as soon as the line is connected. When an intercom call arrives, you will hear the caller talking without the phone ringing. When an outside call arrives, you will hear the caller talking after a preprogrammed number of rings. Hands-free Answerback for outside calls requires system programming.



### To set/cancel

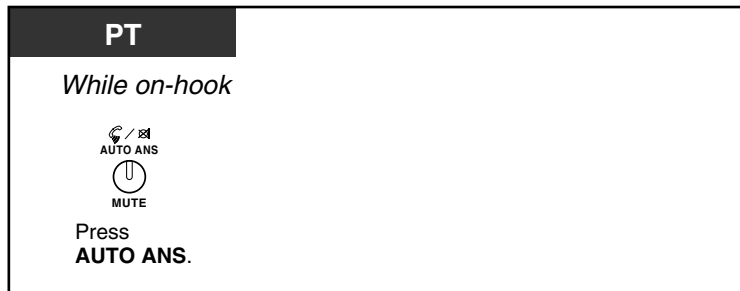

- The AUTO ANS button light shows the current status as follows:
  - Off:** Not set
  - Red on:** Set
- PS users: Refer to "Operating Instructions" for PS.

### 1.3.3 Answering a Call Ringing at Another Telephone (Call Pickup)

- Answering a Call from Another Telephone (Call Pickup)
- Denying Other People the Possibility of Picking Up Your Calls (Call Pickup Deny)

#### ◆◆ Answering a Call from Another Telephone (Call Pickup)

You can answer an incoming call that is ringing at another extension or group from your phone without leaving your desk.

The following types of pickup are available:

**Group Call Pickup:** Picks up a call within your group.

**Directed Call Pickup:** Picks up a specified extension's call.

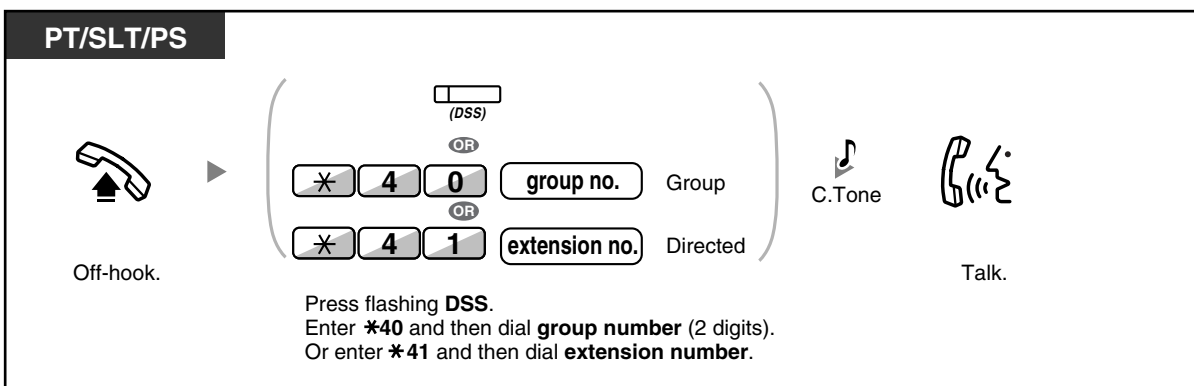

- **If you receive a call waiting tone**, you can ask a third party to pick up your second call with Directed Call Pickup.

#### ◆◆ Denying Other People the Possibility of Picking Up Your Calls (Call Pickup Deny)

You can deny or allow other people to pick up your calls.

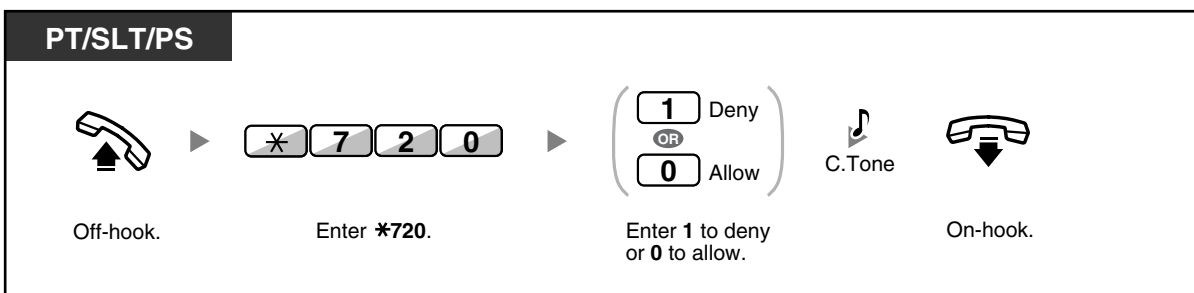



## 1.3.4 Answering a Call via an External Speaker (Trunk Answer From Any Station [TAFAS])

You can be notified of incoming outside calls through an external speaker. These calls can be answered from any extension.

### Through an external speaker

<For users of KX-TDA100/KX-TDA200/KX-TDA600>

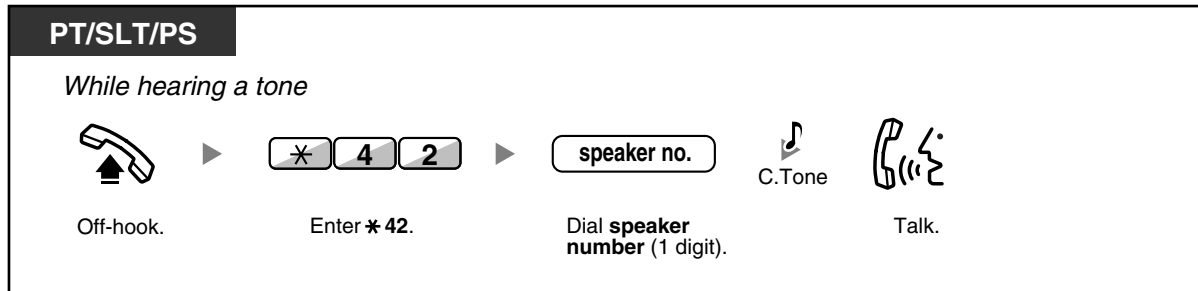

<For users of KX-TDA30>

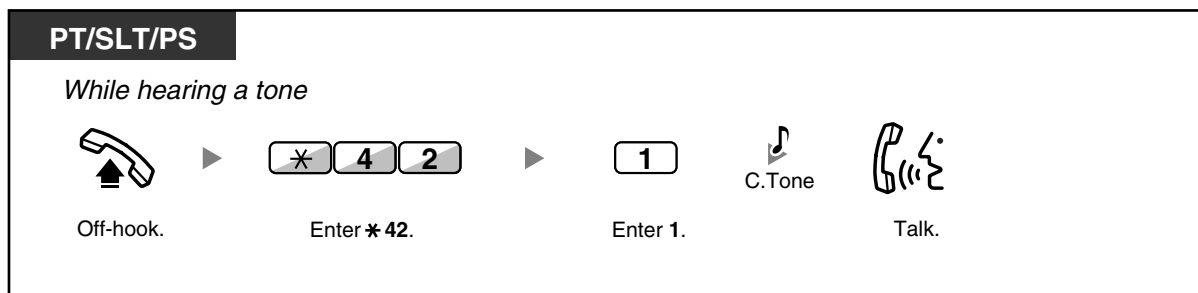

- You can also receive a paging announcement via a speaker with this operation.

### 1.3.5 Using the ANSWER/RELEASE Button

The ANSWER and RELEASE buttons are convenient for operators using headsets. With the ANSWER button, you can answer all incoming calls. With the RELEASE button, you can disconnect the line during or after a conversation, or complete transferring a call.



#### To answer

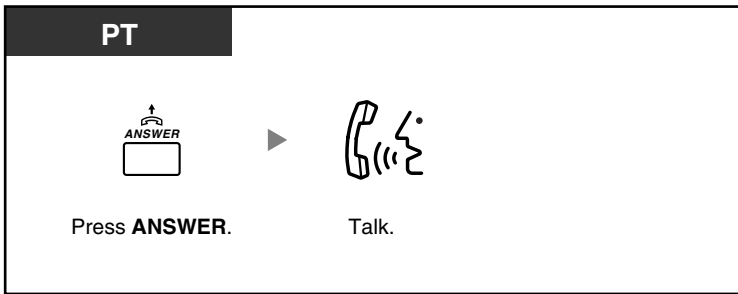

#### To transfer a call

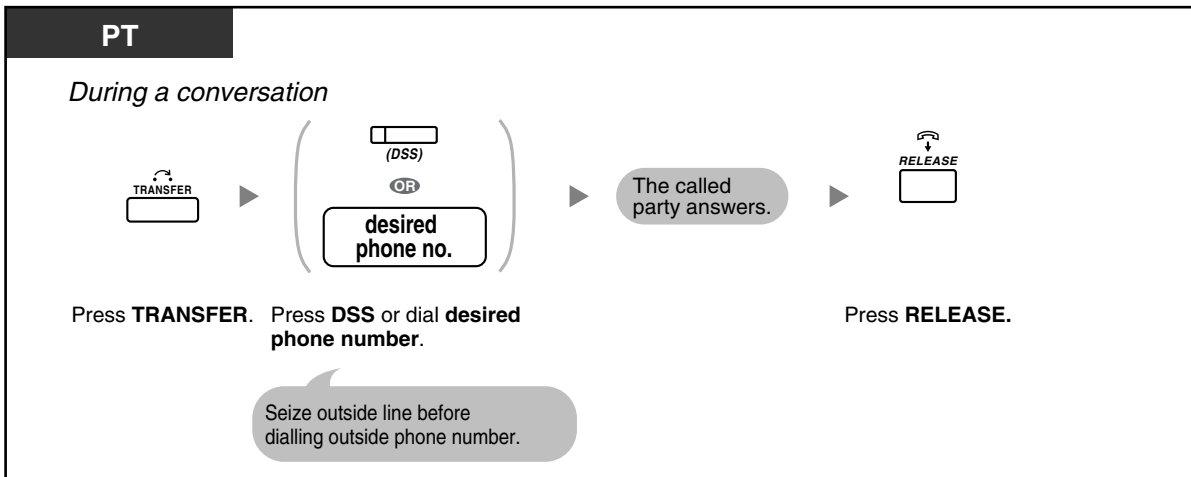

#### To talk to a waiting caller



### To transfer an outside call to an extension with a one-touch operation

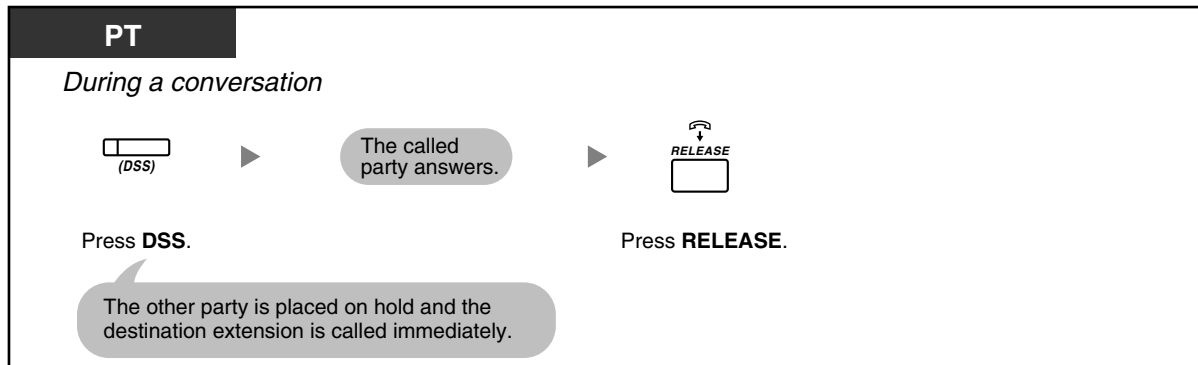

### To end a conversation

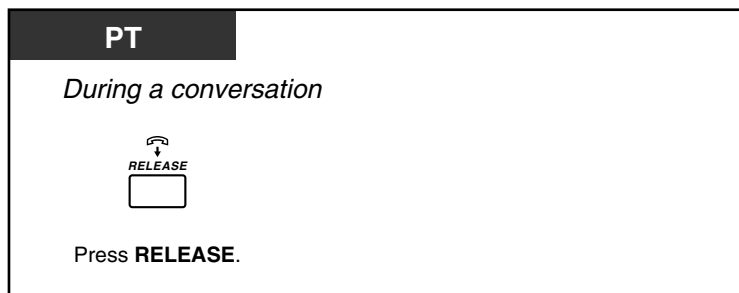

#### Customising Your Phone

- 3.1.3 Customising the Buttons  
Create or edit an Answer button or a Release button.

## 1.3.6 Identifying Malicious Calling Parties (Malicious Call Identification [MCID])

You can ask your telephone company to trace a malicious calling party during a conversation or after the calling party hangs up.

You will receive the information on the malicious call later on.

### To request MCID

**PT/SLT/PS**

*During a conversation or when hearing a reorder tone after the calling party hangs up.*

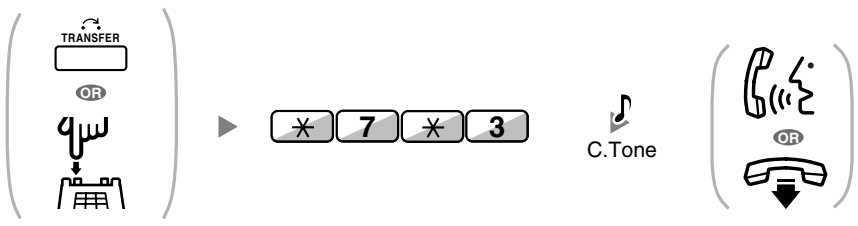

The diagram illustrates the process of requesting Malicious Call Identification (MCID). It is divided into three main steps:

- Step 1:** Press **TRANSFER** or **Recall/hookswitch**. This is represented by a telephone handset icon with a 'TRANSFER' button and a 'Recall/hookswitch' button, with an 'OR' between them.
- Step 2:** Enter **\*7\*3**. This is represented by four buttons labeled with the numbers \* 7 \* 3.
- Step 3:** Talk or on-hook. This is represented by a telephone handset icon with a 'C.Tone' (Call Transfer) icon and an 'OR' between them.

Arrows indicate the sequence from Step 1 to Step 2, and from Step 2 to Step 3.



- Availability of this feature depends on the ISDN service of your telephone company.

## 1.4 During a Conversation

### 1.4.1 Transferring a Call (Call Transfer)

- Transferring to an Extension in the PBX
- Transferring to an Outside Party Using the PBX Service
- Transferring a Call Using the ISDN Service (Call Transfer [CT]—by ISDN)



- You can transfer a held call without talking, and go on-hook even if the transferred party does not answer the call. If a transferred call is not answered within a specified time, it will ring at a preprogrammed extension, if set, or at your extension again. If you are off-hook at that time, you will hear an alarm tone. If an outside call is not answered within a specified time, it is automatically disconnected.

#### ◆◆ Transferring to an Extension in the PBX

##### To transfer

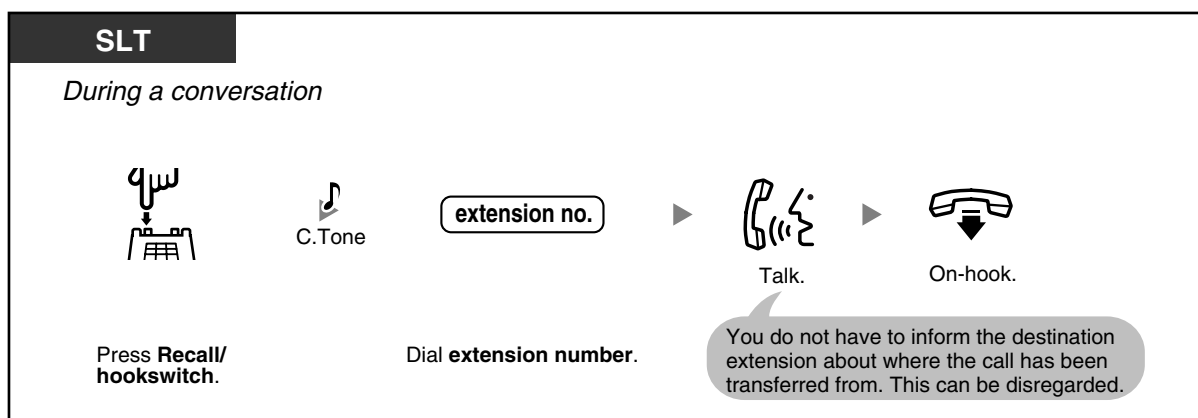
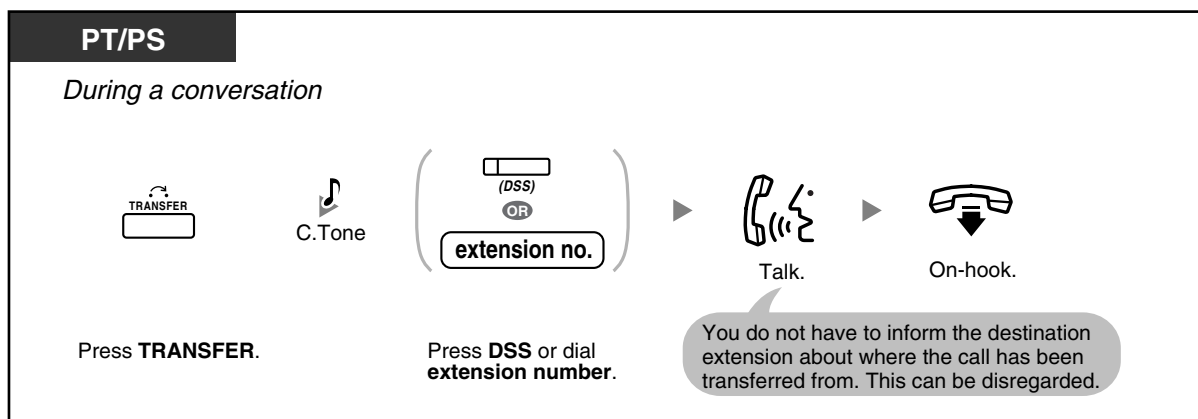

- When you are not at your desk or not in the office and receive a forwarded outside call, for example on your cellular phone, it is possible to transfer the call to an extension in the PBX by pressing # + desired extension number (if enabled through system programming).

## 1.4 During a Conversation



- For the transfer operation using an SDN button, refer to "1.5.1 Primary Directory Number (PDN)/Secondary Directory Number (SDN) Extension (KX-TDA100/KX-TDA200/KX-TDA600 only)".

### To transfer with one touch (One-touch Transfer)

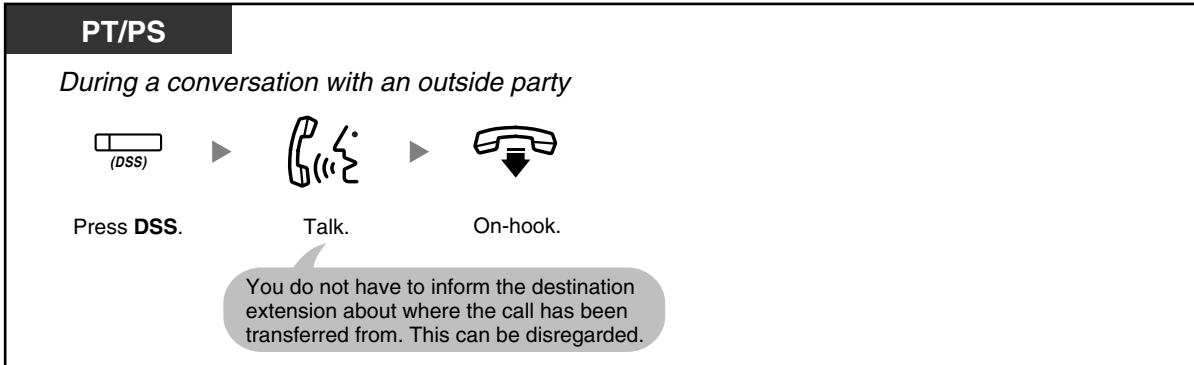

- System programming is required to use the One-touch Transfer feature during a conversation with an extension.

### ◆◆ Transferring to an Outside Party Using the PBX Service

Some extensions may be restricted from performing this feature.

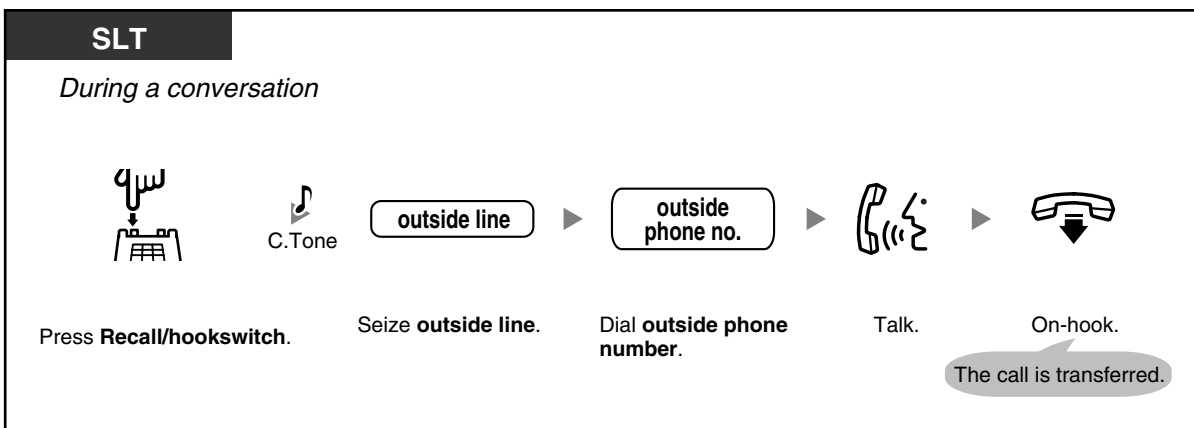
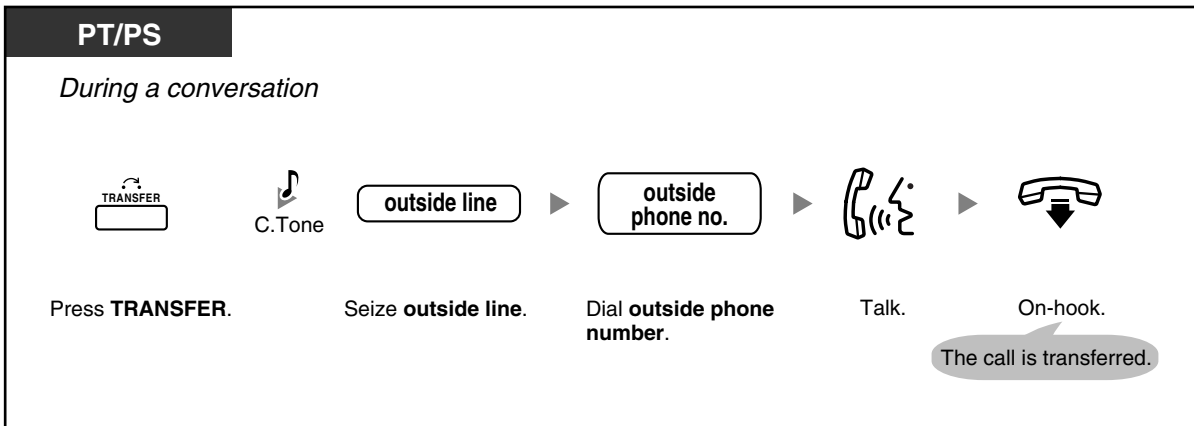



- **Time limit**  
Both the caller and the transferred party will hear an alarm tone fifteen seconds before a specified time period.
- **To return to the held call before the destination answers**, press the TRANSFER button, corresponding CO, ICD Group or INTERCOM button, or the hookswitch.



### Customising Your Phone

- 3.1.3 Customising the Buttons  
Create or edit a Direct Station Selection (DSS) button.

## ◆◆ Transferring a Call Using the ISDN Service (Call Transfer [CT]—by ISDN)

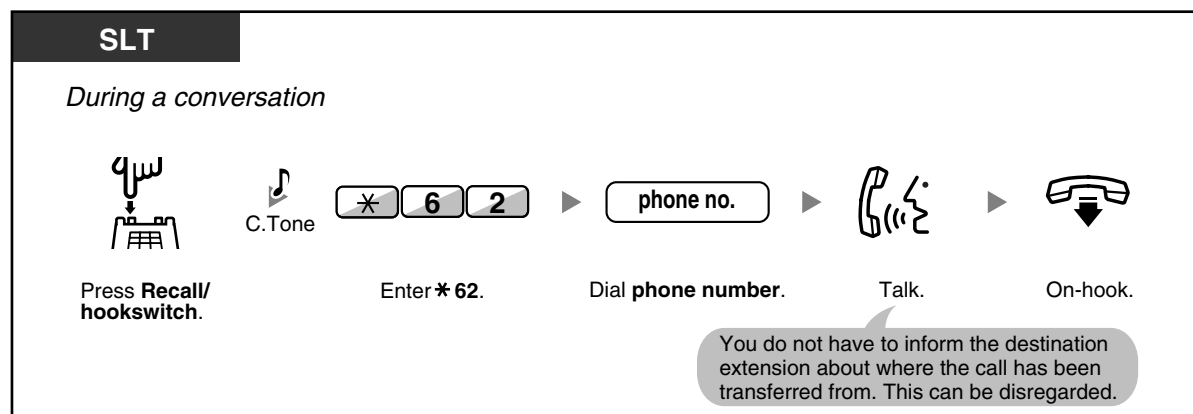
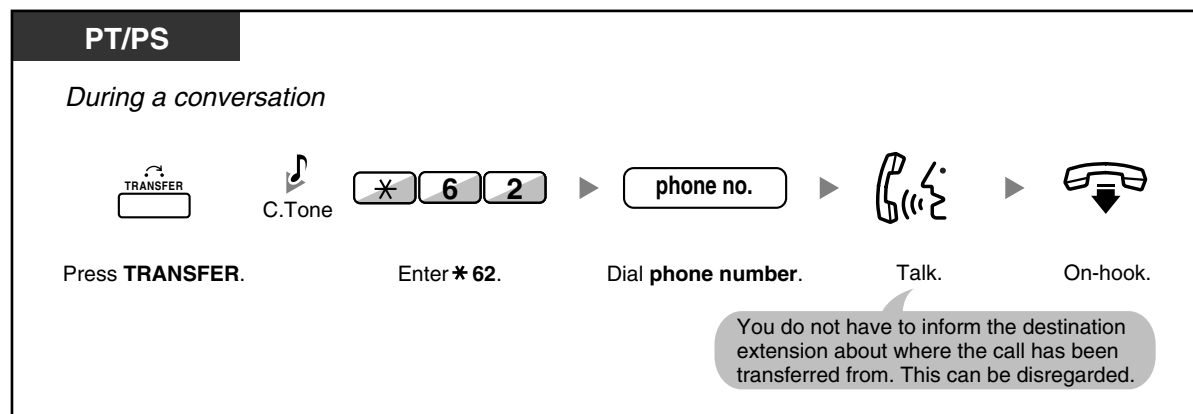
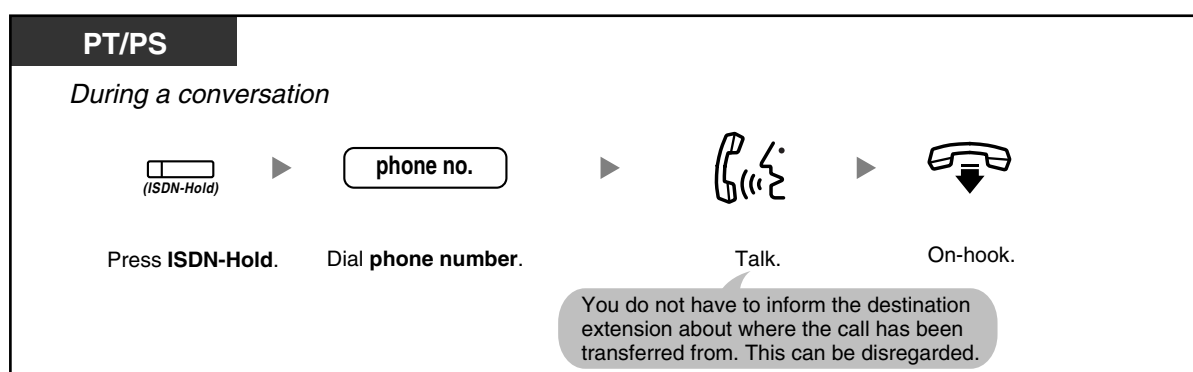

## 1.4 During a Conversation

---



- To retrieve the held call, press the TRANSFER button, Recall/hookswitch.
- Even if you go on-hook while transferring a call, it is transferred.
- After the call is transferred, the line becomes idle.



### **Customising Your Phone**

- 3.1.3 Customising the Buttons  
Create or edit an ISDN-Hold button.



## 1.4.2 Holding a Call

- Holding
- Holding in a System Parking Zone (Call Park)

### ◆◆ Holding

There are two types of hold. The difference between them is that other people can retrieve your held call (Regular Hold) or not (Exclusive Call Hold). As they can be alternated, ask your manager what the current mode is.

#### To hold (Call Hold)

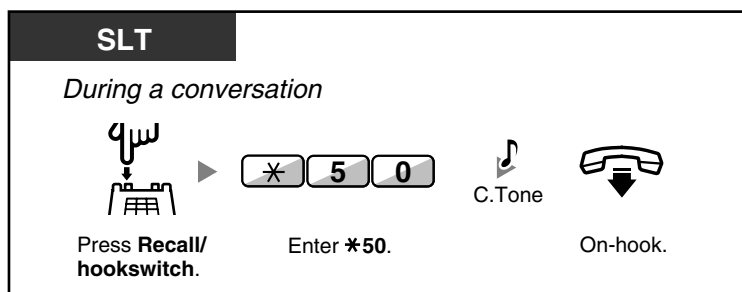
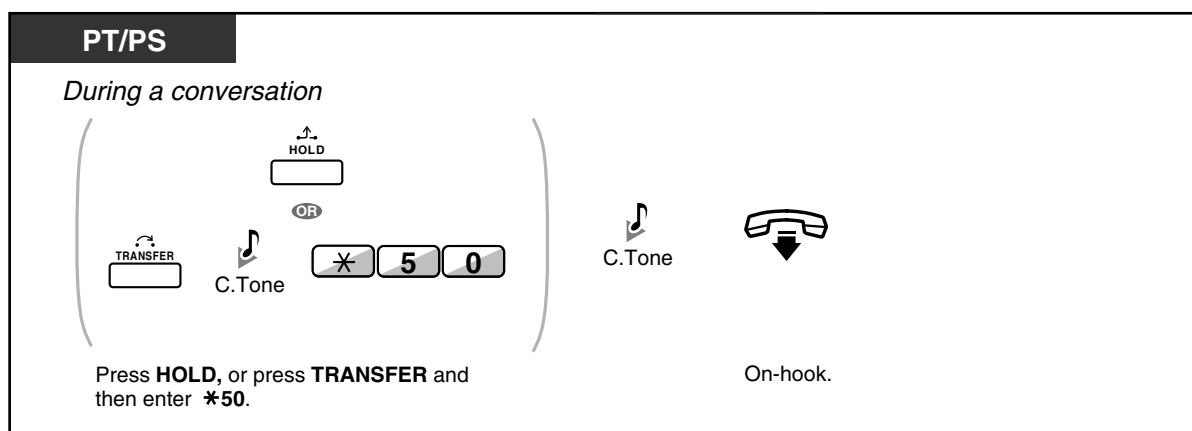

To retrieve a call (Call Hold Retrieve)

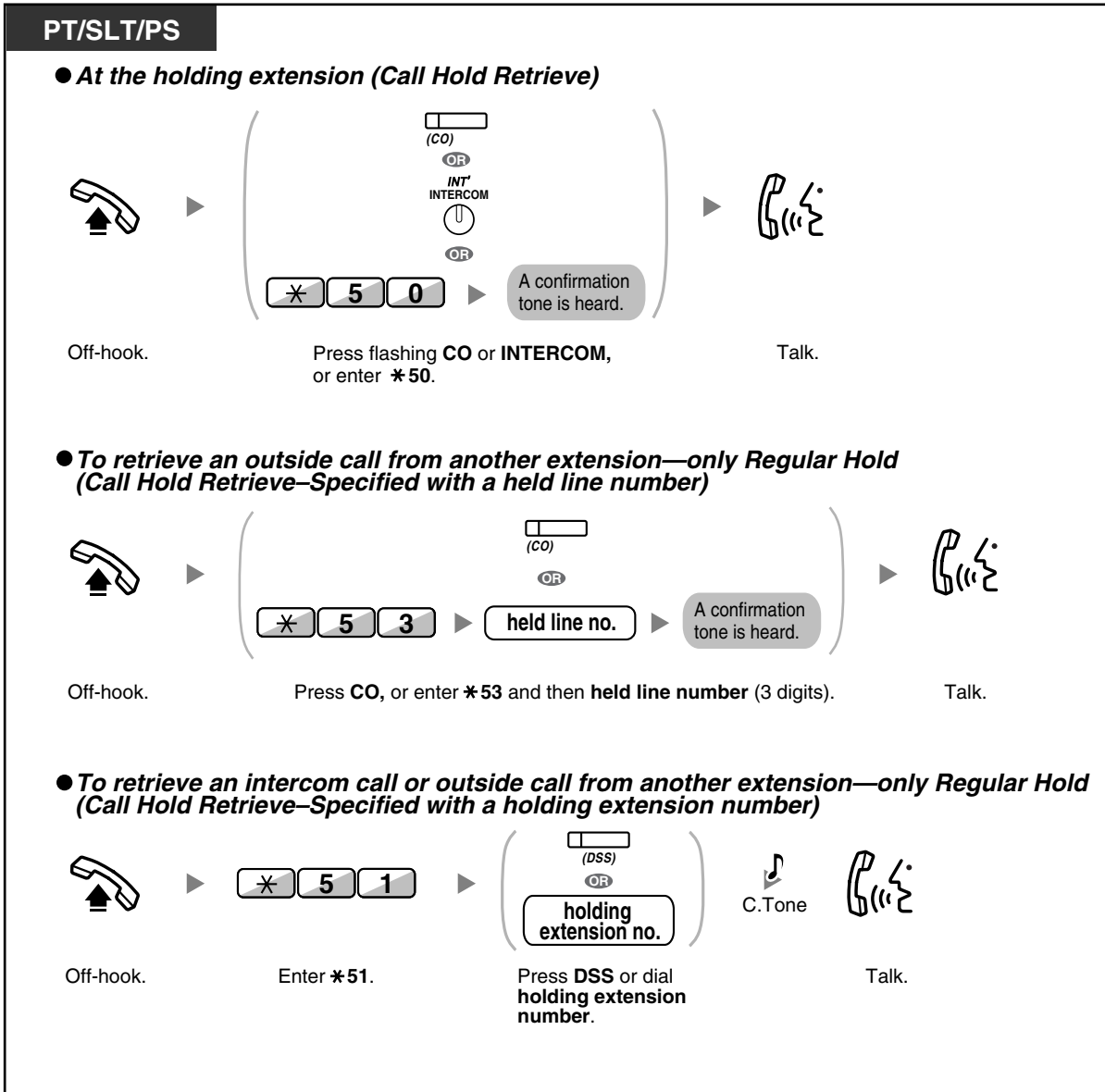

- The CO or INTERCOM button light shows the current status as follows:
    - Regular Hold mode
      - Flashing green slowly:** Your held call
      - Flashing red:** Another extension's held call
    - Exclusive Call Hold mode
      - Flashing green moderately:** Your held call
      - Red on:** Another extension's held call
  - If a call is not retrieved within a specified time**, you will hear an alarm as a reminder (Hold Recall).  
If an outside call is not answered within a specified time, it is automatically disconnected.
  - Hold Mode Change (PT only)**  
After pressing the HOLD button, if you press the HOLD button again, the status switches from the Regular Hold mode to the Exclusive Call Hold mode or from the Exclusive Call Hold mode to the Regular Hold mode.



- If **Automatic Call Hold** has been preprogrammed, you can put the current call on hold automatically by pressing another CO, ICD Group or INTERCOM button to make or answer another call.
- For the Call Hold Retrieve operation using a PDN/SDN button, refer to "1.5.1 Primary Directory Number (PDN)/Secondary Directory Number (SDN) Extension (KX-TDA100/KX-TDA200/KX-TDA600 only)".

## ◆◆ Holding in a System Parking Zone (Call Park)

You can put a call on hold in a common parking zone of the PBX so that any extension can retrieve the parked call. You can use this feature as a transferring feature.

A call can be put into either a specified parking zone (Specified) or any idle parking zone (Auto). If a Call Park button and Call Park (Automatic Park Zone) button have been established, you can select either way to park by simply pressing the corresponding button.

When a call is parked automatically, or more than one call has been parked at the same time, you need to specify the parking zone number to retrieve the required call.

### To set

PT/PS

*During a conversation*

(Call Park)

Press **Call Park**.

PT/PS

*During a conversation*

Press **TRANSFER**.

Enter **\*52**.

parking zone no.

Specified

OR

\*

Auto

C.Tone

On-hook.

Enter a specified **parking zone number** (2 digits) or press **\*** to park at an idle parking zone automatically.

If you hear a busy tone, enter another parking zone number or press **\*** again.

## 1.4 During a Conversation

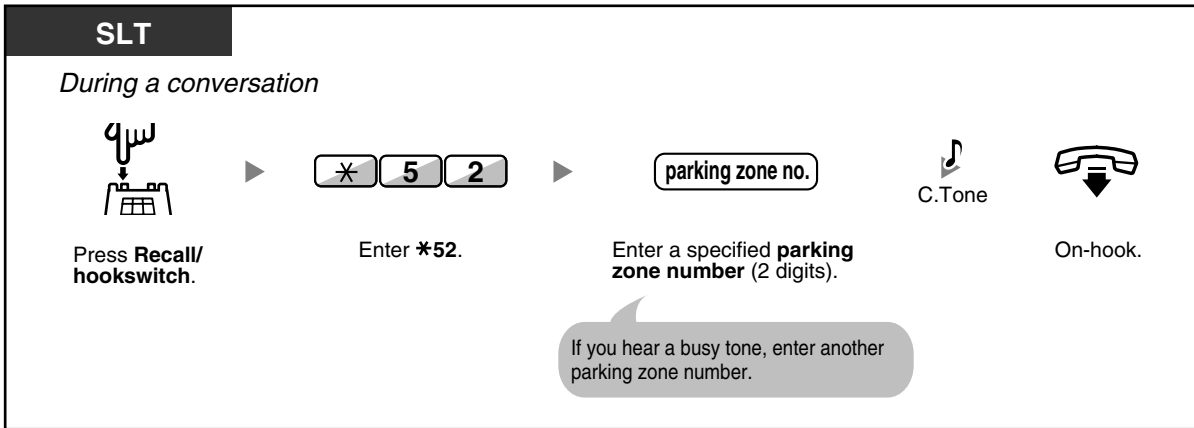

### To retrieve (Call Park Retrieve)

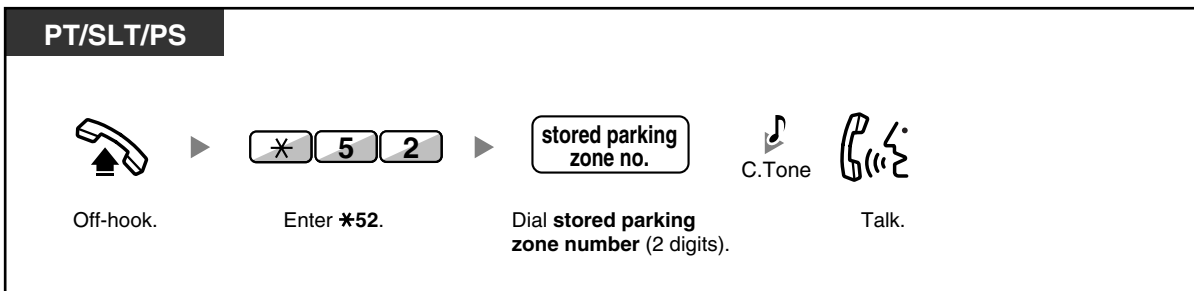
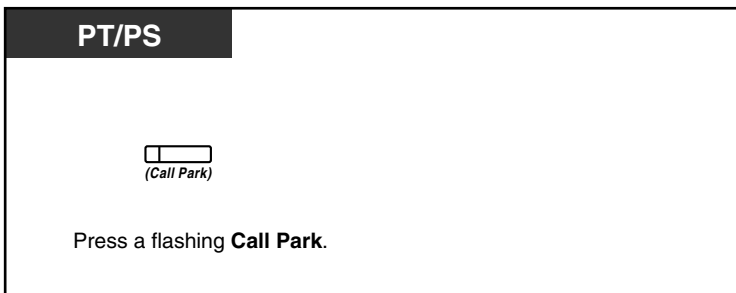

- If a call is parked automatically, confirm the parking zone number on the display.
- **If a call is not retrieved within a specified time**, you will hear an alarm as a reminder (Call Park Recall).  
If an outside call is not answered within a specified time, it is automatically disconnected.
- **If you hear a reorder tone when retrieving a parked call**, there is no held call. Confirm the stored parking zone number.
- After you park a call, you can perform other operations.

### Customising Your Phone

- 3.1.3 Customising the Buttons  
Create or edit a Call Park button or Call Park (Automatic Park Zone) button.

### 1.4.3 Talking to Two Parties Alternately (Call Splitting)

When talking to one party while the other party is on hold, you can swap the calls back and forth (alternately).

To alternate between the parties leaving one party on hold temporarily

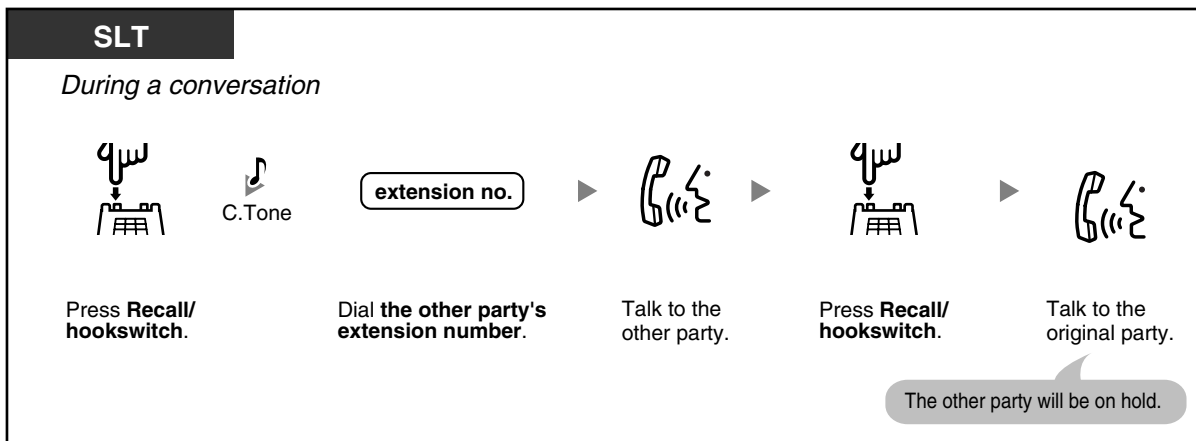
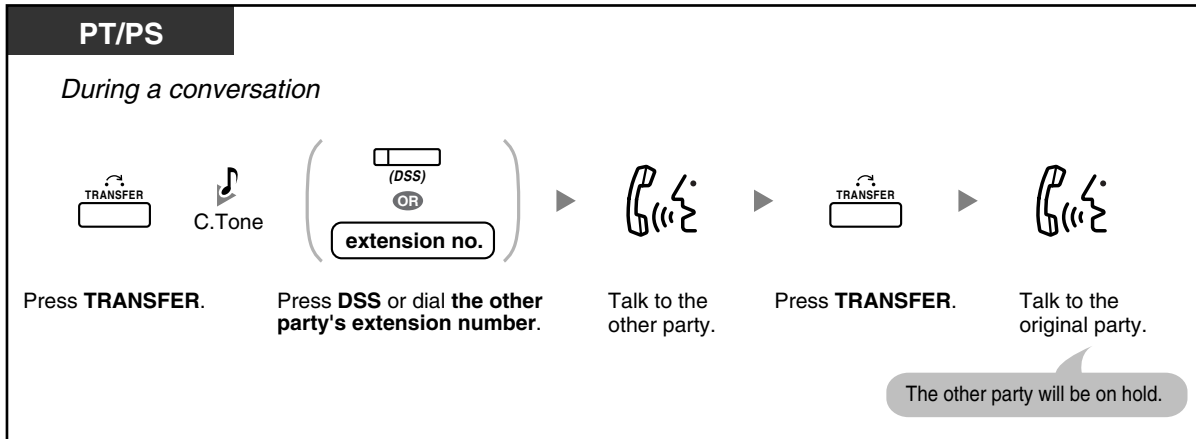

## 1.4 During a Conversation

### To leave the conversation and then let the two parties talk

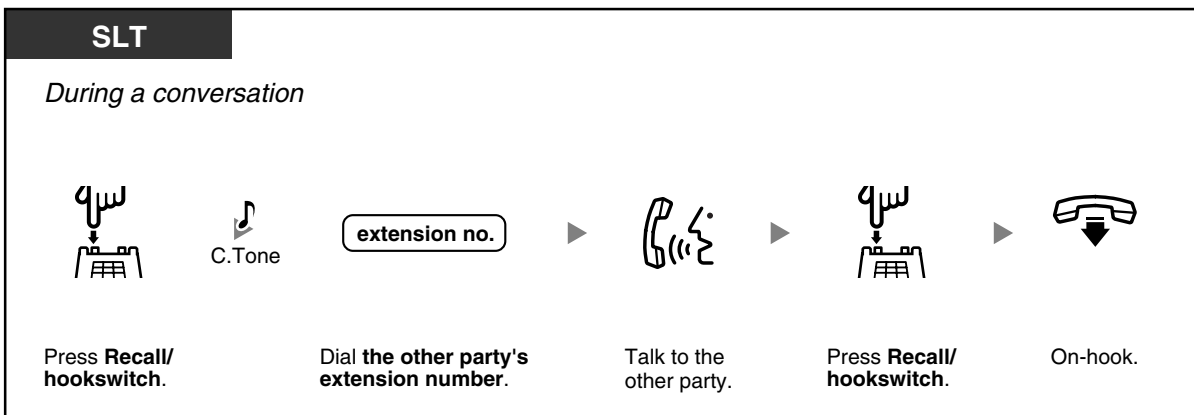
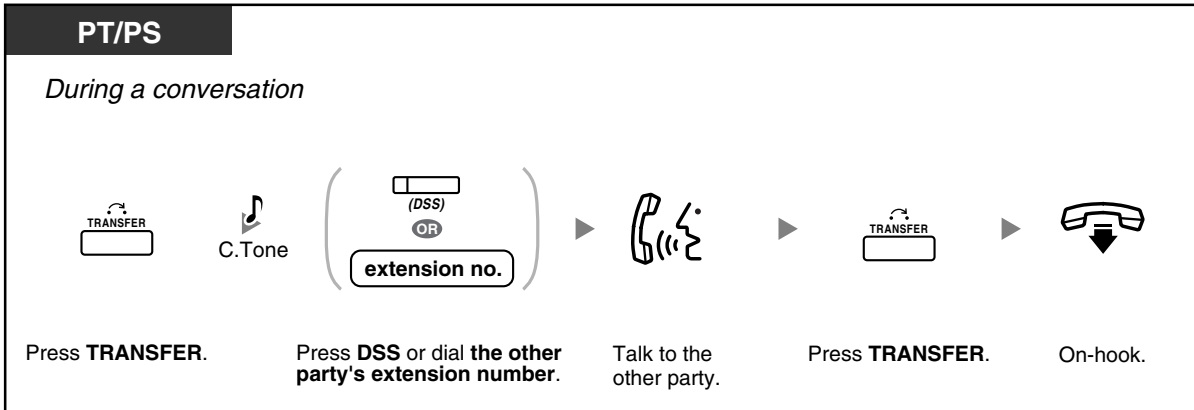

## 1.4.4 Answering Call Waiting

- Answering Call Waiting in the PBX
- Answering Call Waiting from the Telephone Company

### ◆◆ Answering Call Waiting in the PBX

During a conversation, a call waiting tone or voice announcement through the speaker or the handset occurs when an outside call has been received or another extension is letting you know a call is waiting. You must activate this feature to use it. (Default: Disable—No call [Intercom calls]/No tone [Outside calls])

**You can answer the second call by disconnecting (1) or holding (2) the current call.**

#### 1. To disconnect the current call and then talk to the new party

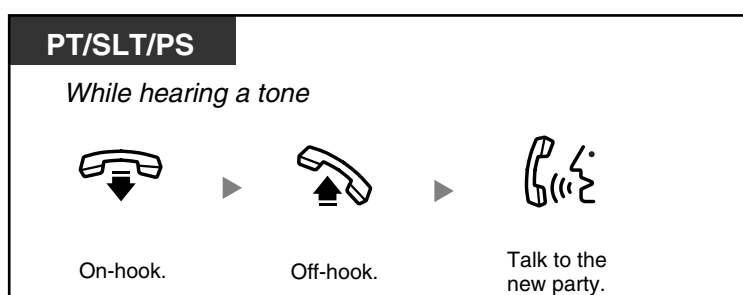

#### 2. To hold the current call and then talk to the new party

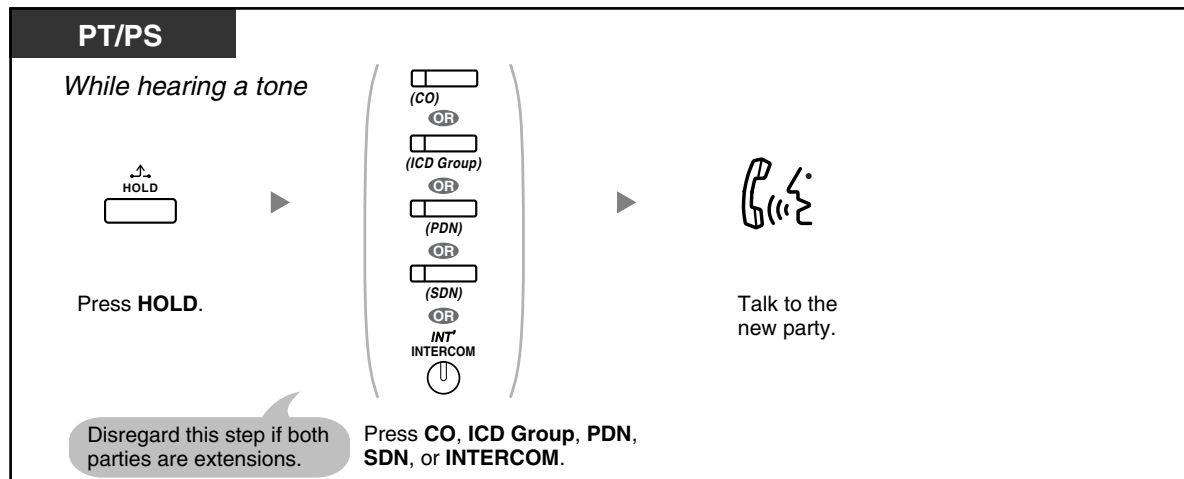

## 1.4 During a Conversation

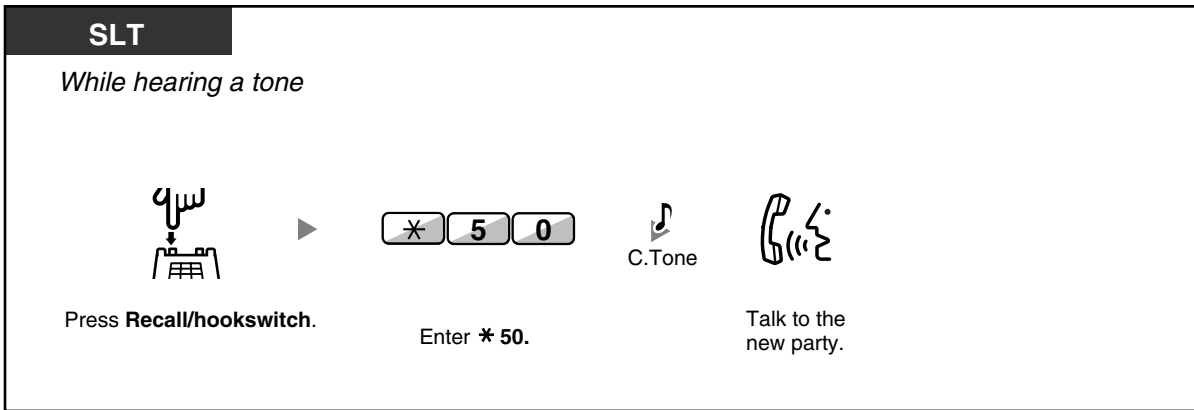

After talking to the new party (second call), you can disconnect (2.1) or hold (2.2) it and then retrieve the first call.

### 2.1 To disconnect the second call and then talk to the original party

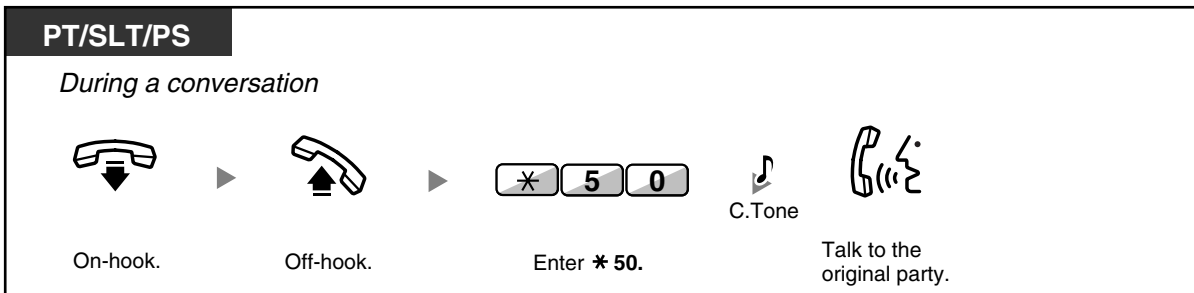
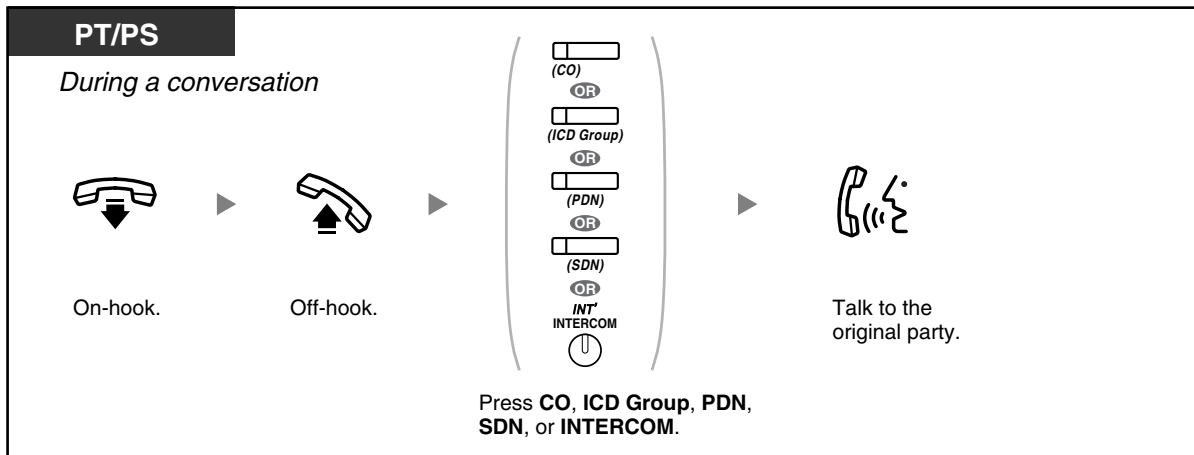



## 2.2 To hold the second call and then talk to the original party

After holding it, you can talk to the original party. Then, you can disconnect it and then talk to the new party again.

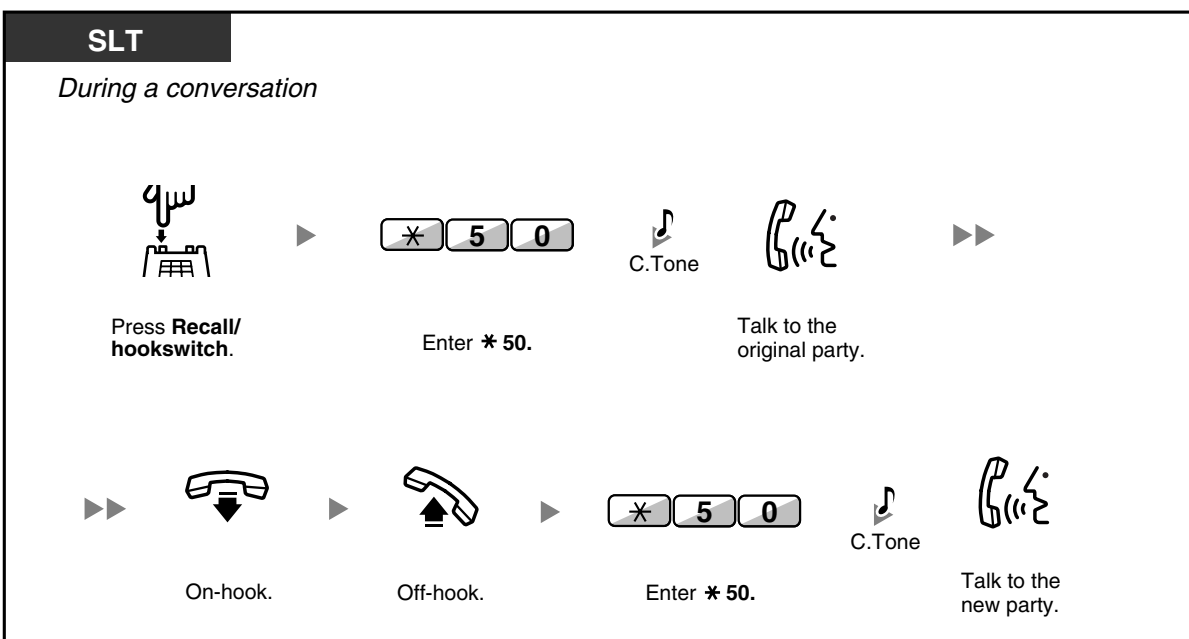
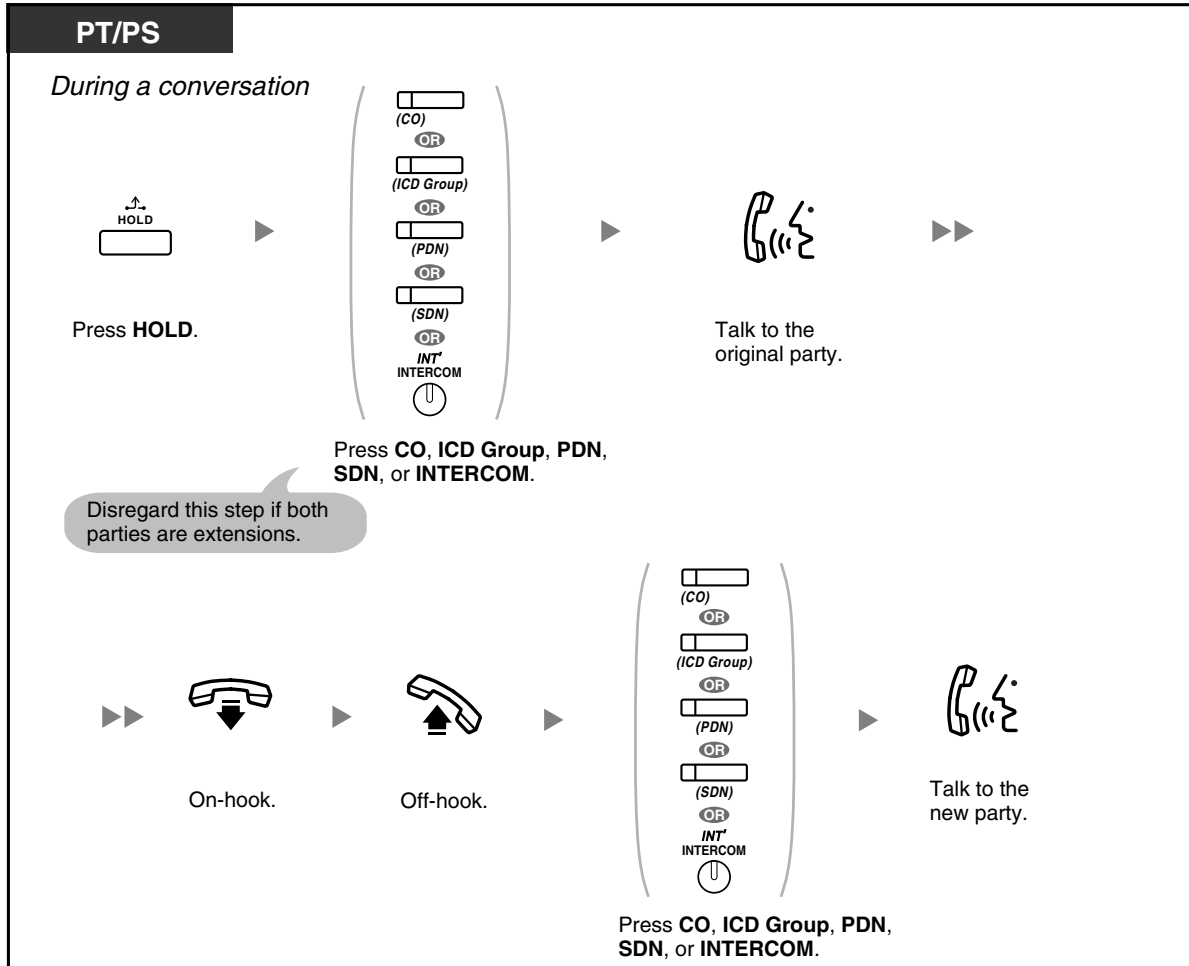

## 1.4 During a Conversation



- **Depending on the type of your telephone**, you may be able to talk to the other party using the speaker and the microphone (Off-hook Call Announcement [OHCA]), or you can receive an announcement through the handset (Whisper OHCA), if you are having a conversation using the handset.  
Refer to "1.8.3 Receiving Call Waiting (Call Waiting/Off-hook Call Announcement [OHCA]/Whisper OHCA)".
- The caller's name or number is displayed for five seconds in fifteen second intervals while waiting to be answered.



### Customising Your Phone

- 3.1.2 Settings on the Programming Mode—**Call Waiting Tone Type Selection**  
If you select "Tone 1", you will hear the same tone for Call Waiting from an outside party and an extension. If you select "Tone 2", you will hear different tones for Call Waiting from an outside party and an extension.

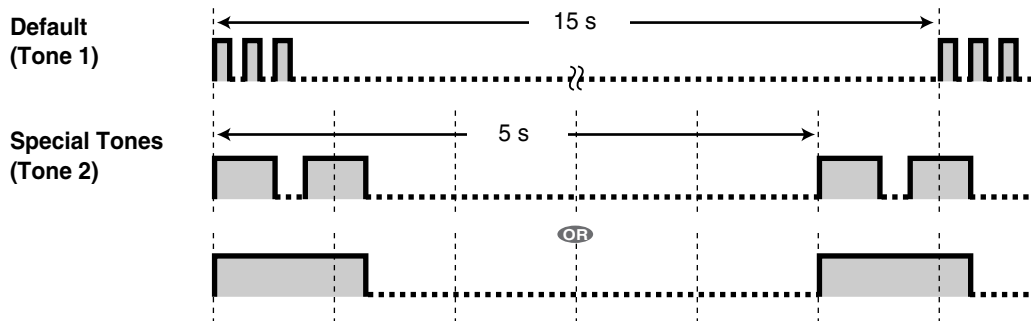

## ◆◆ Answering Call Waiting from the Telephone Company

This is an optional telephone company service. You can receive a call waiting tone and the caller's information. For details, consult your telephone company.

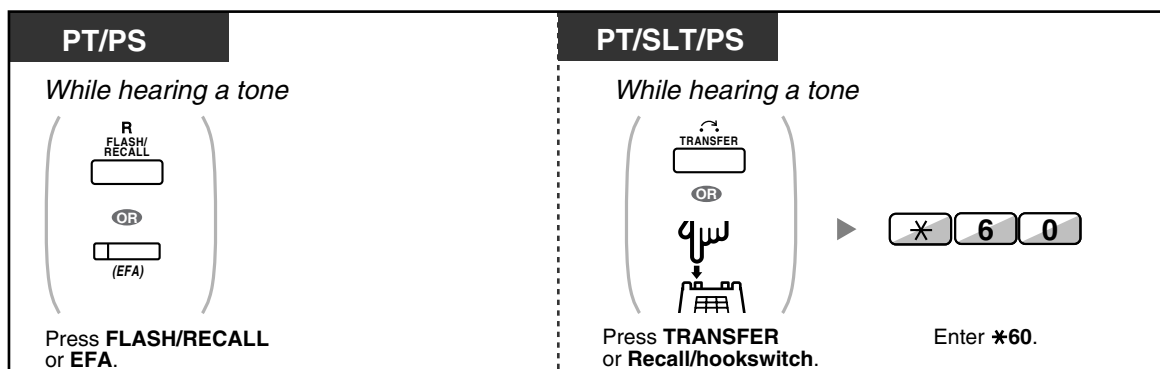

- **To return to the original party**, repeat the operation.
- In this case, the FLASH/RECALL button on proprietary telephones must be set to External Feature Access (EFA) mode through system programming.



### Customising Your Phone

- 3.1.3 Customising the Buttons  
Create or edit an External Feature Access (EFA) button.

## 1.4.5 Multiple Party Conversation

- Adding Other Parties during a Conversation (Conference)
- Leaving a Conference (Unattended Conference)
- Leaving a Conference (Leaving Three-party Conference)
- Letting a Third Party Join Your Call (Privacy Release)
- Adding a Third Party during a Conversation Using the ISDN Service (Three-party Conference [3PTY]—by ISDN)

### ◆◆ Adding Other Parties during a Conversation (Conference)

You can add one or more parties to your conversation.

#### To establish a conference call

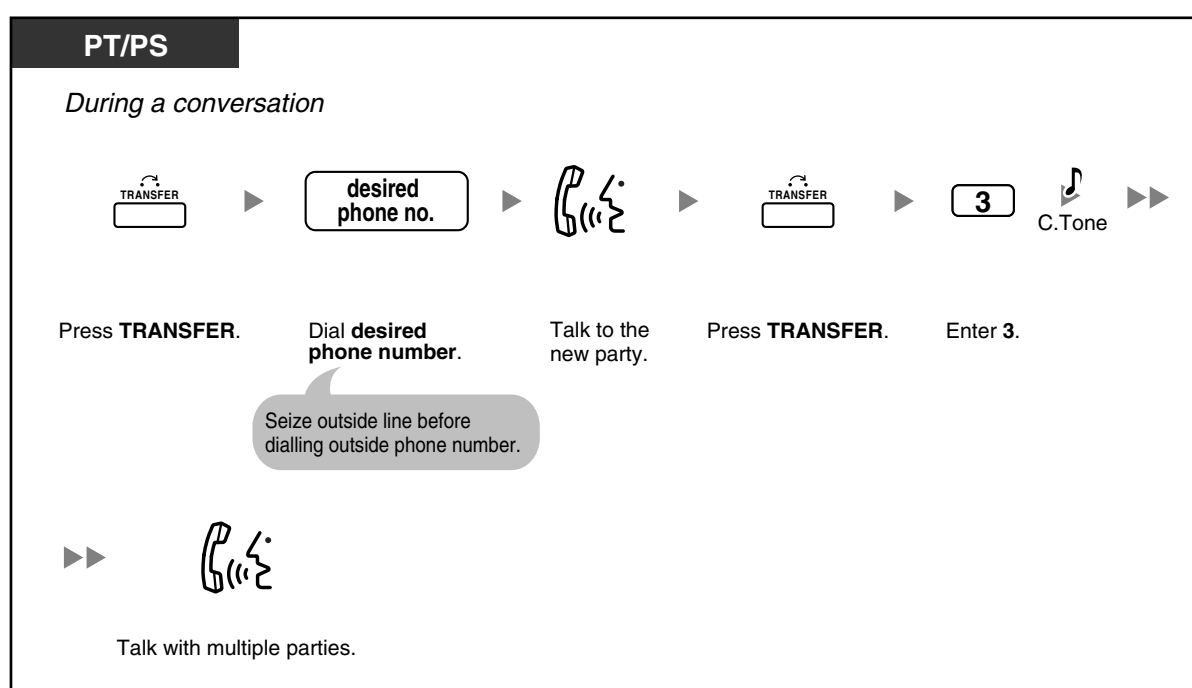
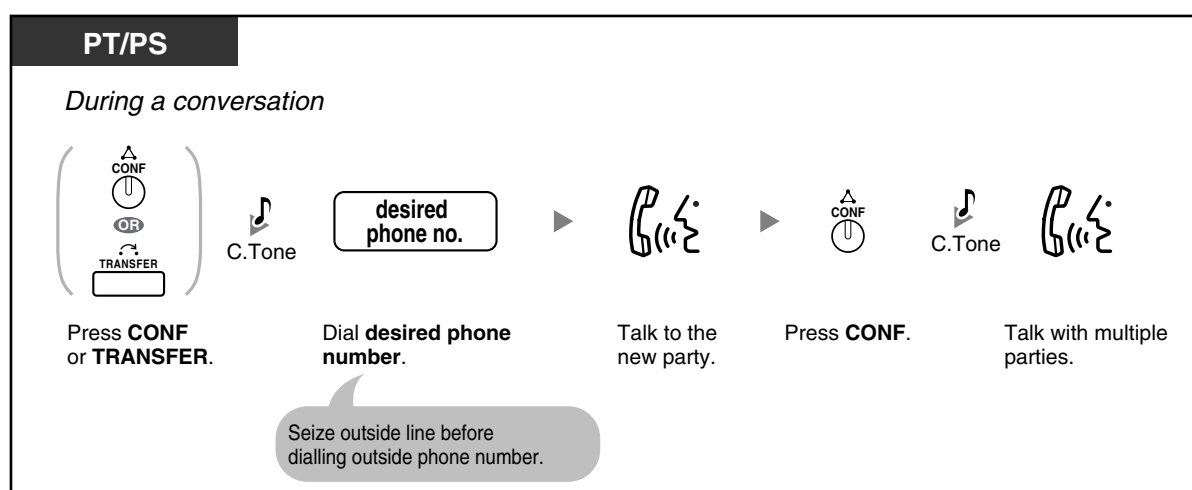

## 1.4 During a Conversation

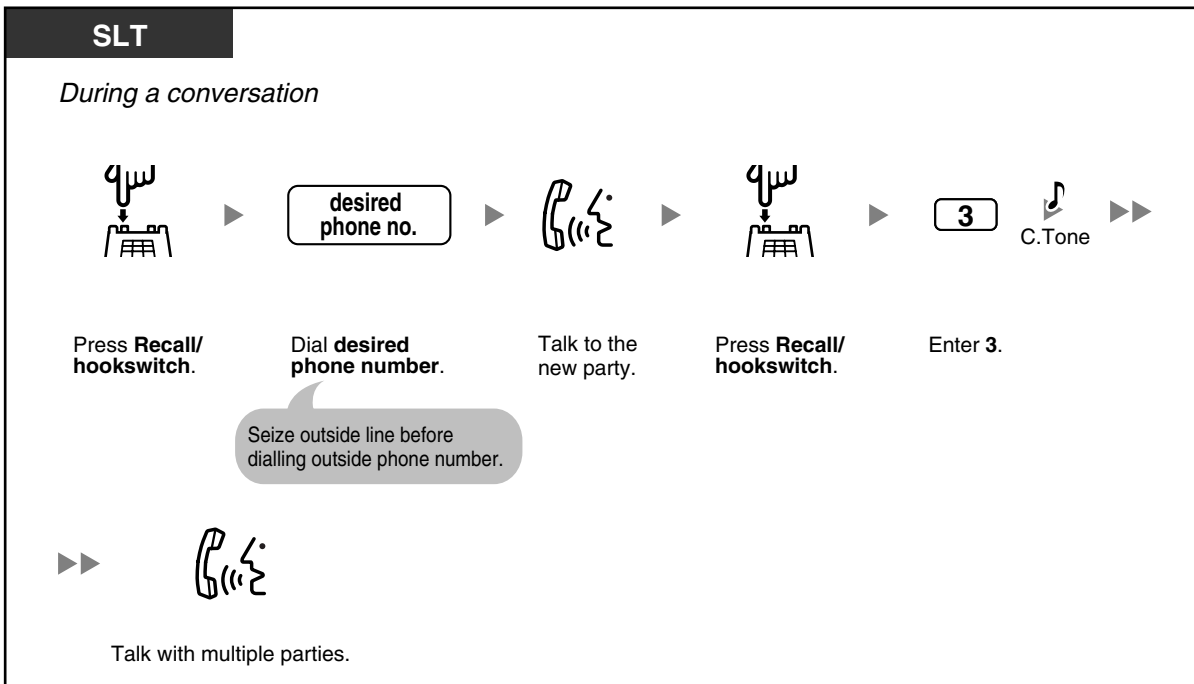

### To establish a conference call when receiving a call from an outside party during a two-party conversation

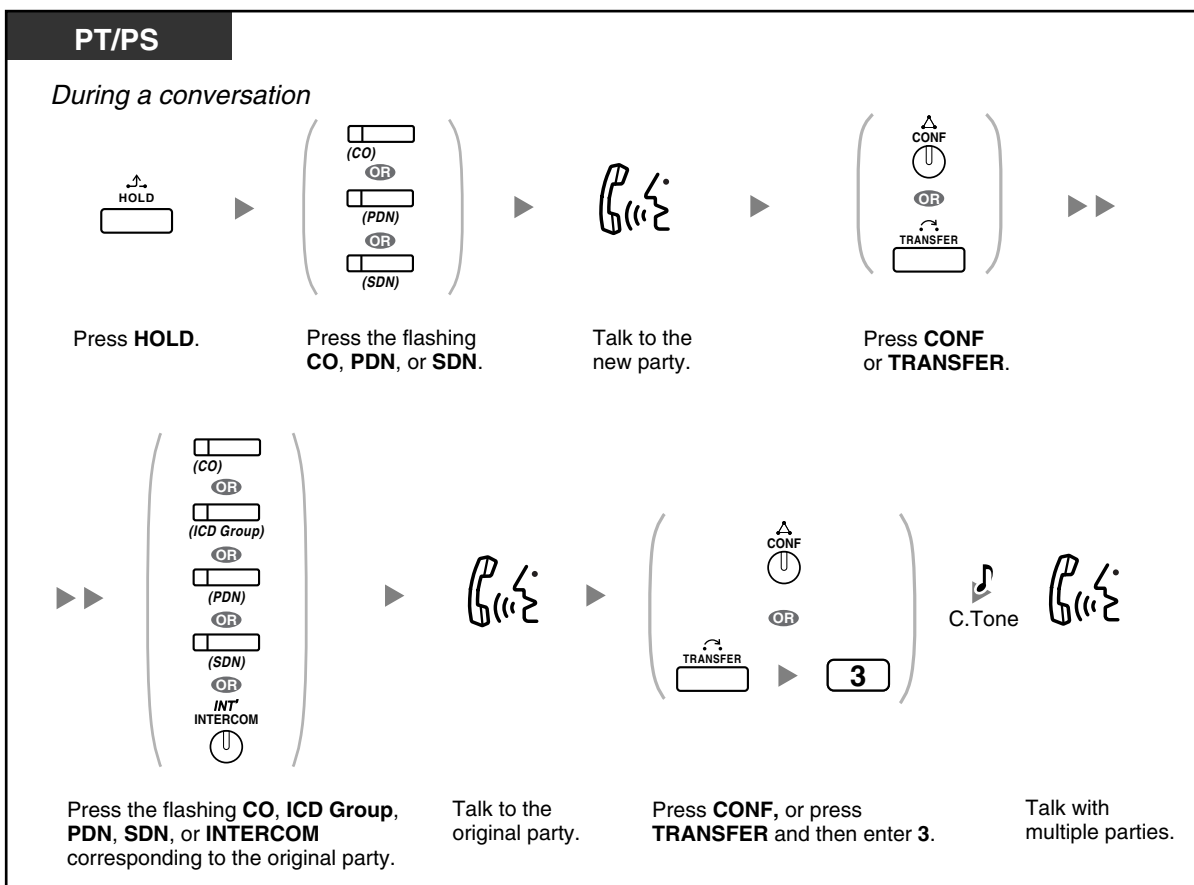

**To add four or more parties to a conference**

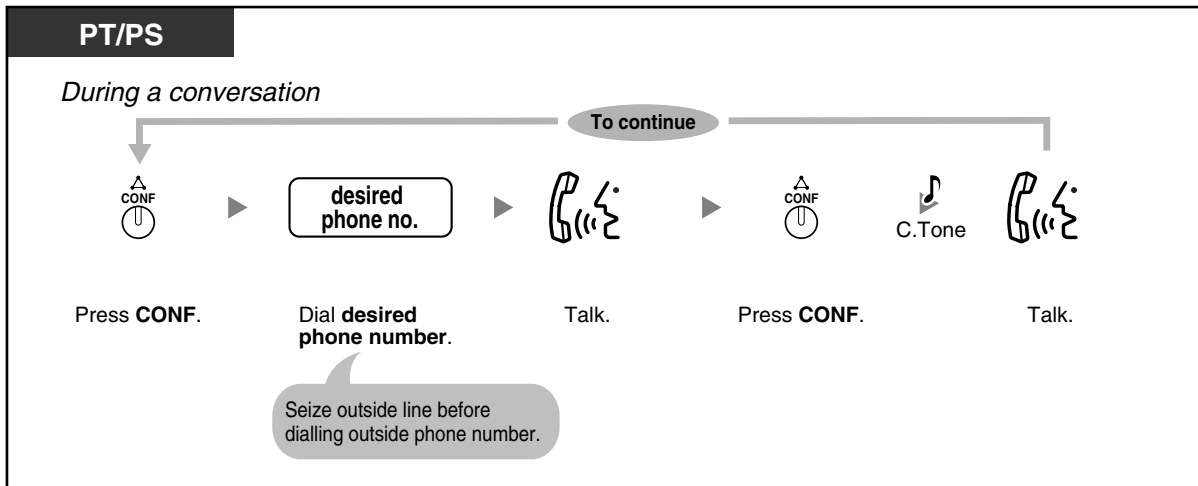

**To add another party on hold to a conference**

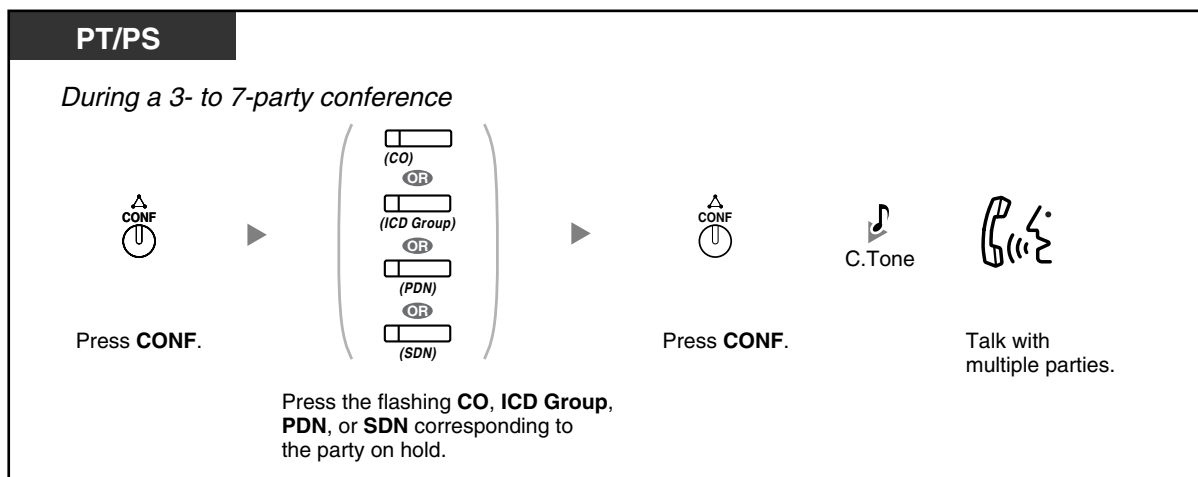

**To talk to two parties alternately in a three-party conversation**

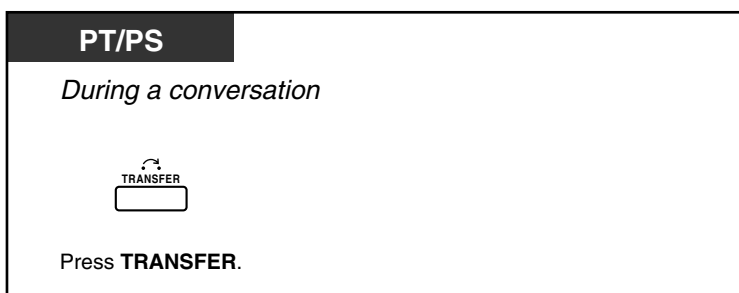

## 1.4 During a Conversation

SLT

*During a conversation*



Press **Recall/hookswitch**.

### To disconnect one party and then talk to the other in a three-party conversation

PT/PS

*During a conversation*



Press **TRANSFER** once or twice to establish a conversation with the party to be disconnected.



Press **FLASH/RECALL**.\*

(CO)

OR

(ICD Group)

OR

(PDN)

OR

(SDN)

OR

INT\*

INTERCOM

⏏

Press the flashing **CO, ICD Group, PDN, SDN, or INTERCOM** corresponding to the party on hold.



Talk.

The other party will be put on hold.



- \* In this case, the FLASH/RECALL button on a proprietary telephone must be set to Flash/ Recall mode through system programming.
- During a three-party conversation, pressing the TRANSFER button or Recall/hookswitch alternates between the other parties in the conversation.
- You can have a conference with a maximum of eight parties (comprising intercom or outside lines) simultaneously.
- During a conversation involving four or more parties, you cannot disconnect one party and maintain the conversation with the other parties.



#### Customising Your Phone

- 3.1.3 Customising the Buttons  
Create or edit a Conference button.

## ◆◆ Leaving a Conference (Unattended Conference)

The person who originated a conference can leave the conference, and allow the other parties to continue the conversation.



### To leave a conference

PT/PS

*During 3- to 7-party conference*



Press **CONF**.

▶



On-hook.

### To return while others are talking

PT/PS



(CO)

OR



(ICD Group)

OR



(PDN)

OR



(SDN)

OR



INT  
INTERCOM

Press flashing green **CO**, **ICD Group**, **PDN**, **SDN**, or **INTERCOM**.

### To complete a conversation

PT/PS

*During a conversation*



On-hook.



- **Time limit**  
Both parties will hear an alarm tone before a specified timeout. The originating extension user will hear an alarm tone before timeout. The call is disconnected when the timer runs out unless the originating extension returns to the conference.



#### Customising Your Phone

- 3.1.3 Customising the Buttons  
Create or edit a Conference button.

## ◆◆ Leaving a Conference (Leaving Three-party Conference)

The person who originated a conference with two other parties can leave the conference, and allow the other parties to continue the conversation.

### To leave a conference involving at least one other extension

**PT/SLT/PS**

*During a three-party conference*



On-hook.

### To leave a conference involving two outside parties

**PT/PS**

*During a three-party conference*



Press **TRANSFER**.      On-hook.

**SLT**

*During a three-party conference*



Press **Recall/hookswitch**.      On-hook.



- To leave a conference call involving two outside parties and have the conversation continue, your extension must be enabled to transfer calls to outside lines through COS programming.



## ◆◆ Letting a Third Party Join Your Call (Privacy Release)

You can let a third party join your current outside call and establish a three-party conversation. You can also leave the conversation and then let the two other parties talk.



To let a third party join your conversation and establish a three-party conversation

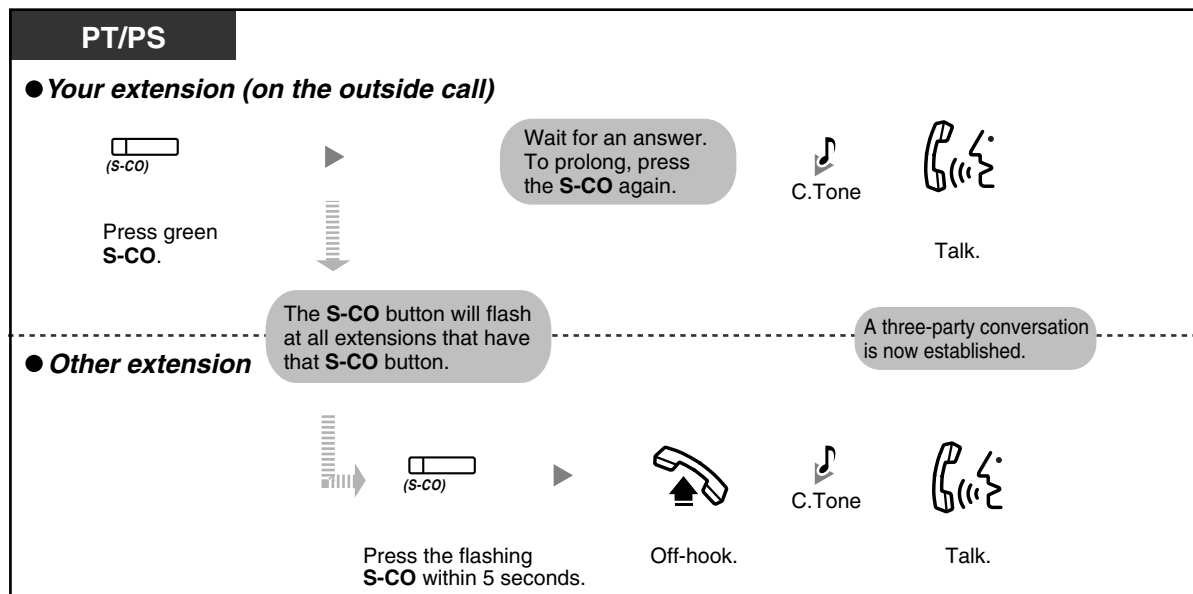

- Only an S-CO button can be used for this operation.
- You can leave a three-party conversation and let the two other parties talk by simply going on-hook.

## ◆◆ Adding a Third Party during a Conversation Using the ISDN Service (Three-party Conference [3PTY]—by ISDN)

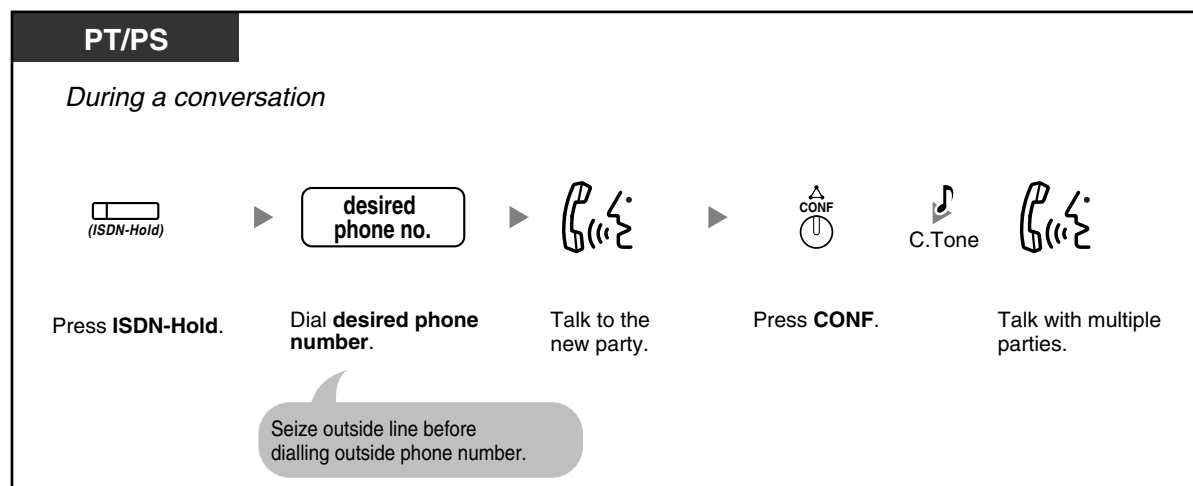

## 1.4 During a Conversation

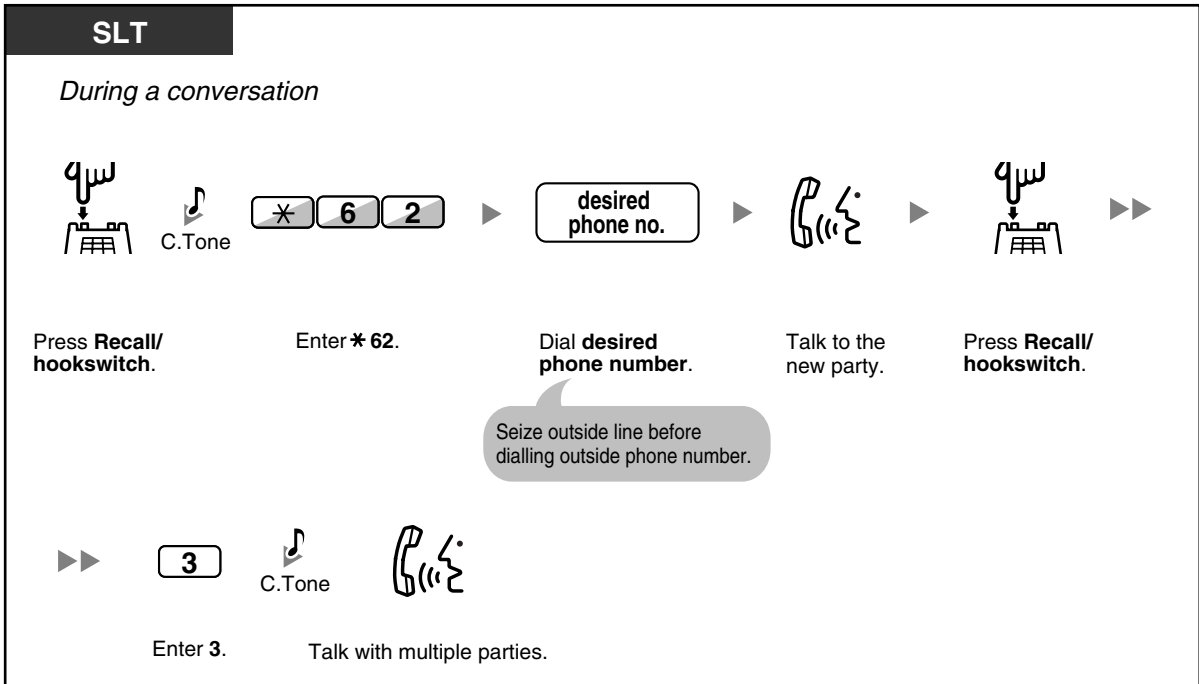
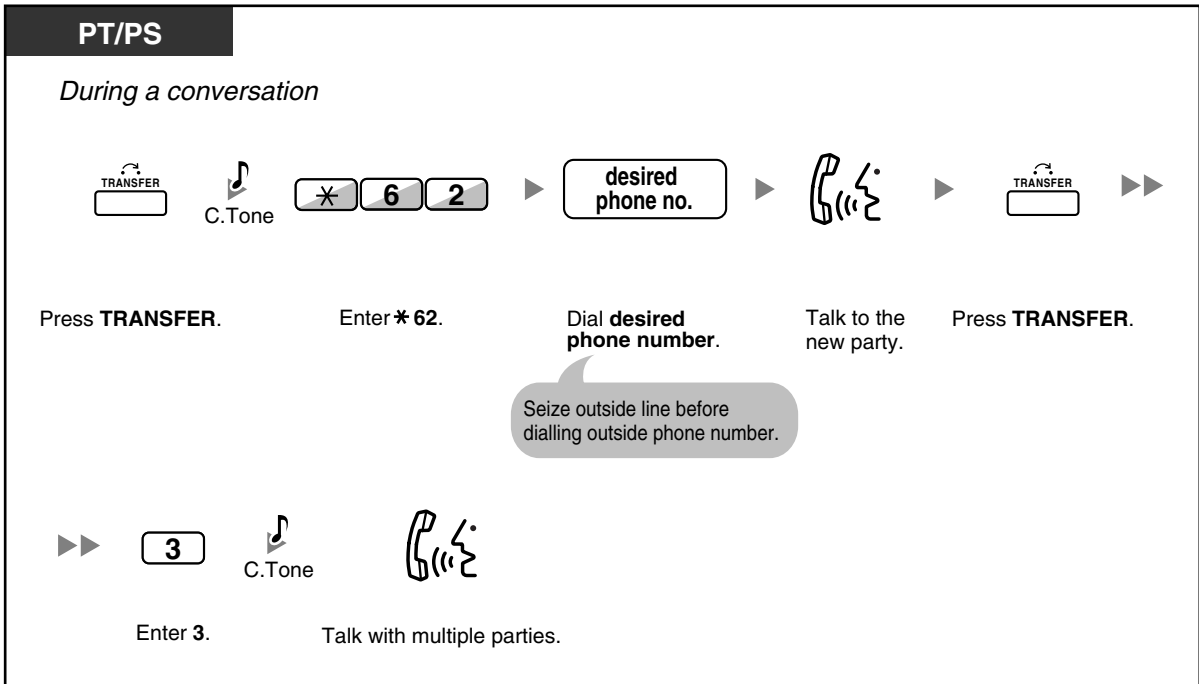

**To complete a conversation****Customising Your Phone**

- 3.1.3 Customising the Buttons  
Create or edit an ISDN-Hold button.

## 1.4.6 Mute

You can disable the microphone or the handset to consult privately with others in the room while listening to the other party on the phone through the speaker or the handset.



### To set/cancel

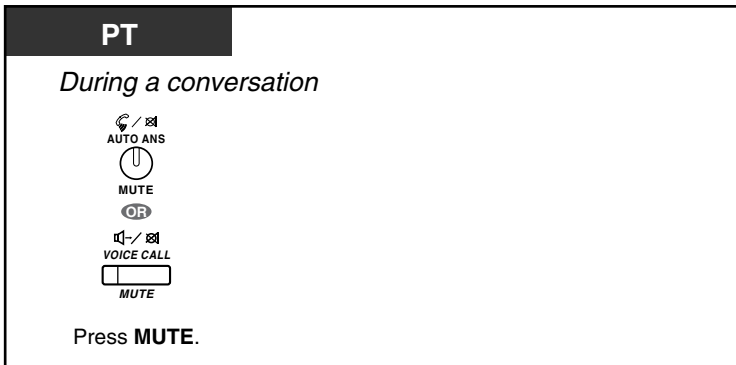

- The AUTO ANS/MUTE or VOICE CALL/MUTE button light shows the current status as follows:
  - Off:** Normal
  - Flashing red:** Mute
- If mute is used during OHCA, it will become Handset Mute.

## 1.4.7 Letting Other People Listen to the Conversation (Off-hook Monitor)

You can let other people in the room listen to the conversation through the speaker while continuing the conversation using the handset.



### To set/cancel

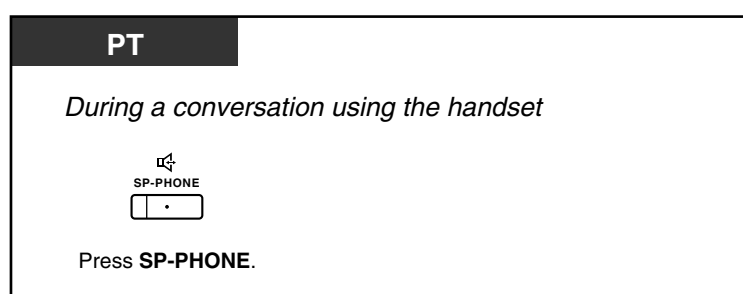

- The SP-PHONE button light shows the current status as follows:
  - Off:** The voice is heard through the handset.
  - On:** The voice is heard through the speaker and the handset.
- This feature is only available with certain proprietary telephones, and requires system programming.



- Hands-free operation**  
You can have a conversation in hands-free mode using the SP-PHONE button. You can perform other tasks simultaneously.
- Helpful hints for hands-free operation:**
  - If it is difficult to hear the other party's voice,**  
Increase the volume using the Navigator Key, Jog Dial, or Volume Key.
  - If the other party has difficulty hearing you,**  
Decrease the volume.
  - If the other party reports that your voice echoes,**  
Use the telephone in a room that has curtains, carpeting or both.
  - If parts of the conversation cannot be heard,**  
If you and the other party speak at the same time, parts of your conversation may be lost. To avoid this, try to speak alternately.

## 1.4.8 Using the Headset (Headset Operation)

You can have a conversation using a headset.

In this case, you must select "Headset on" in programming mode or set the Headset button on (red) in advance.

This feature is also known as Handset/Headset Selection.



### To talk using the headset



### To use the handset during a conversation using the headset



### To talk in hands-free mode during a conversation using the headset

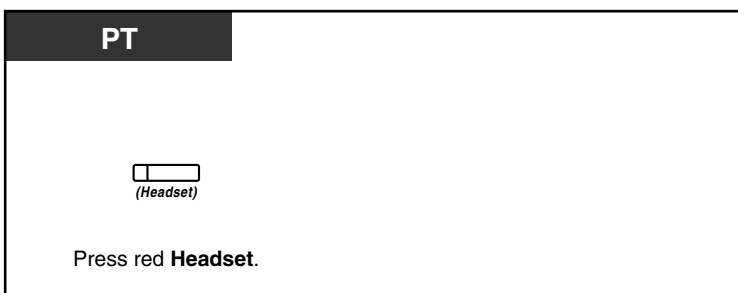

- The Headset button light shows the current status as follows:  
**Off:** Headset mode off  
**Red on:** Headset mode on
- This feature is not available for the KX-T7665.



### Customising Your Phone

- 3.1.2 Settings on the Programming Mode—**Headset Operation**  
Select the equipment to use.
- 3.1.3 Customising the Buttons  
Create or edit a Headset button.

## 1.5 Using a PDN/SDN Button

### 1.5.1 Primary Directory Number (PDN)/Secondary Directory Number (SDN) Extension (KX-TDA100/KX-TDA200/KX-TDA600 only)

Primary Directory Number (PDN) buttons and Secondary Directory Number (SDN) buttons are useful when extension users will handle calls for other extensions. For example, a secretary or multiple secretaries can handle calls and check the call status of a boss or multiple bosses. The functions of PDN and SDN buttons are as follows:



**PDN button:** This button can be used to make and receive all calls (including both outside and intercom calls). Having multiple PDN buttons allows multiple calls to be queued at the extension. Extensions that have a PDN button are called PDN extensions.

**SDN button:** The light of an SDN button displays the current call status of the registered extension, similar to a DSS button. In addition, this button can be used to perform the following operations:

- call the PDN extension (SDN Direct Dial)
- answer calls ringing at the PDN extension
- hold calls and retrieve calls held by the PDN extension (Call Hold and Call Hold Retrieve)
- transfer calls to the PDN extension (Call Transfer Using SDN Button)

Extensions that have an SDN button are called SDN extensions.



- The extension that is registered as the destination of an SDN button must have at least one PDN button.
- One extension can have up to 8 PDN buttons.
- An extension can have only one SDN button for each PDN extension.
- A PDN extension can only receive OHCA or Whisper OHCA from the corresponding SDN extension. When a call is made from another extension, a PDN extension will receive a call waiting tone.
- The button light of each PDN/SDN button shows the current status as follows:

Light Pattern	PDN Button Status	SDN Button Status
<b>Off</b>	The PDN extension is idle.	
<b>Green on</b>	The extension is on a call using the PDN button.	The extension is on a call using an SDN button.
<b>Flashing green slowly</b>	A call is on hold at the PDN extension (Regular Hold).	A call answered with the SDN button is on hold (Regular Hold).
<b>Flashing green moderately</b>	A call is on hold temporarily or on Exclusive Call Hold.	A call answered with the SDN button is on hold temporarily or on Exclusive Call Hold.



Light Pattern	PDN Button Status	SDN Button Status
<b>Flashing green rapidly</b>	The PDN extension is receiving an incoming call.	An SDN extension is receiving a Hold Recall or callback ringing from a call answered with the SDN button.
<b>Red on</b>	A corresponding SDN extension is using the line.	The corresponding PDN extension or another corresponding SDN extension is using the line.
<b>Flashing red slowly</b>	A corresponding SDN extension is holding a call.	Another corresponding SDN extension, or the PDN extension itself, is holding a call.
<b>Flashing red rapidly</b>	The PDN extension is receiving an incoming call to an incoming call distribution (ICD) group.	The corresponding PDN extension is receiving an incoming call.

## ◆◆ SDN Direct Dial

Using an SDN button, you can easily call the corresponding PDN extension. SDN buttons are in one of two modes depending on system programming, and the operation procedure differs as follows:

### Enhanced DSS Key Mode

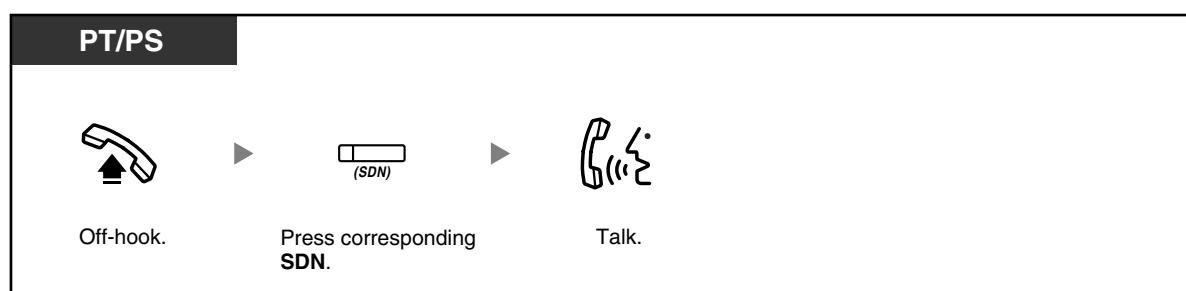

### Standard SDN Key Mode

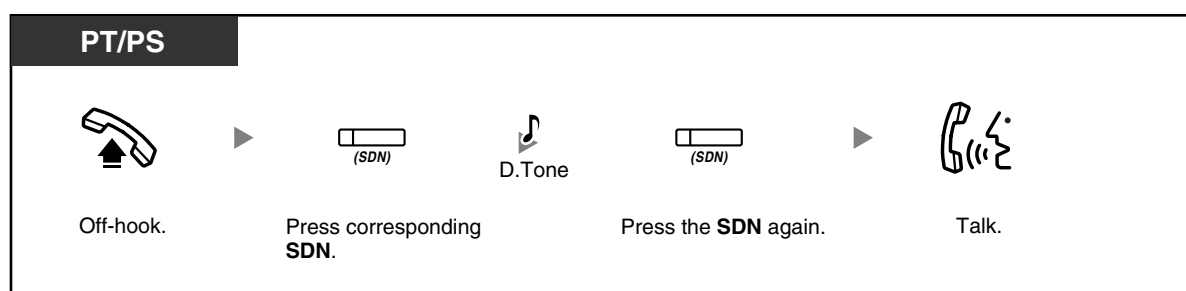

- When performing SDN Direct Dial to call the corresponding PDN extension, the SDN button light shows the current status of the destination extension as follows:
  - Green on:** You are using the line.
  - Red on:** The line is being used. (The PDN extension, or another SDN extension when multiple extensions have SDN buttons to a same PDN extension, is using the line.)
- Even if a PDN extension has set Do Not Disturb (DND), you can call the extension as normal by pressing the SDN button.



- When an SDN button is in Standard SDN Key Mode, you can dial a telephone number while hearing a dial tone, instead of pressing the SDN button again. Depending on system programming, your call will be made using either your normal calling privileges (Class of Service) or those of the corresponding PDN extension (**SDN Walking COS**).

### ◆◆ Call Hold and Call Hold Retrieve



You can put calls answered with a PDN or SDN button on hold normally (**1.4.2 Holding a Call**).

You can also retrieve a call held at your extension/another extension with a simple operation, regardless of the call type.

#### Call Hold Retrieve

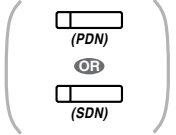

**PT/PS**

● **To retrieve a call at the holding extension**

 →  → 

Off-hook.                      Press flashing green  
**PDN or SDN.**                      Talk.

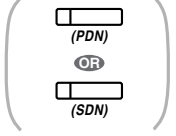
● **To retrieve a call from another extension—only Regular Hold**

 →  → 

Off-hook.                      Press flashing red  
**PDN or SDN.**                      Talk.



- **If a call is not retrieved within a specified time**, you will hear an alarm as a reminder (Hold Recall).  
If an outside call is not answered within a specified time, it is automatically disconnected.



- If **Automatic Call Hold** has been preprogrammed, you can put the current call on hold automatically by pressing another PDN button to make or answer another call.

## ◆◆ Call Transfer Using SDN Button

You can transfer a call to a PDN extension with a simple operation using a corresponding SDN button.

### To transfer a call to a PDN extension

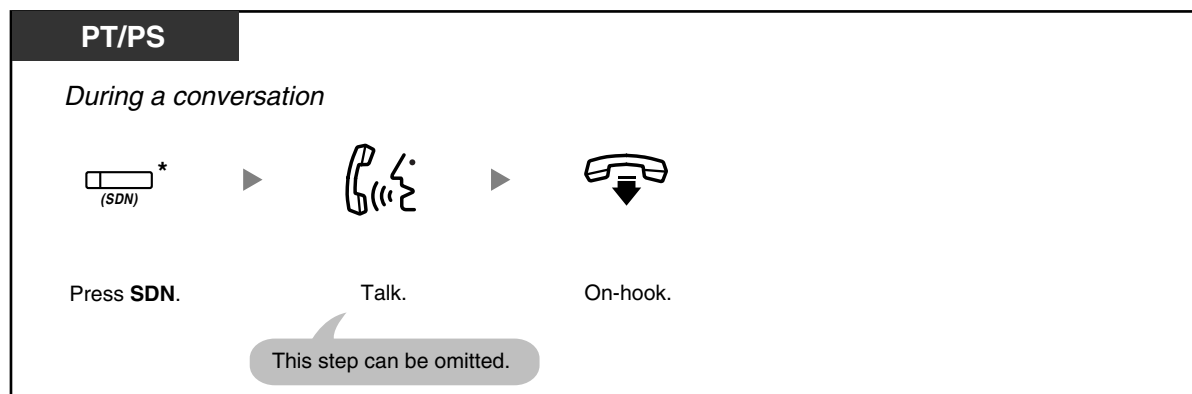

- System programming is required to use this feature during a conversation with an extension.
- \* When an SDN button is in Standard SDN Key Mode, you have to press the SDN button twice to transfer the call, unless you used that SDN button to answer an incoming call.



### Customizing Your Phone

- 3.1.2 Settings on the Programming Mode—**Preferred Line Assignment—Incoming**  
Select the seized line when going off-hook.
- 3.1.2 Settings on the Programming Mode—**Preferred Line Assignment—Outgoing**  
Select the seized line when going off-hook.
- 3.1.3 Customising the Buttons  
Create or edit a Primary Directory Number (PDN) or Secondary Directory Number (SDN) button.

# 1.6 Before Leaving Your Desk

## 1.6.1 Forwarding Calls

- Forwarding Your Calls (Call Forwarding [FWD])
- FWD/DND Settings Using Fixed FWD/DND Button
- Forwarding Your Calls Using ISDN Service (Call Forwarding [CF]—by ISDN)

### ◆◆ Forwarding Your Calls (Call Forwarding [FWD])

You can have your incoming calls forwarded to a specified destination.

**All Calls:**

All calls are forwarded. Preset extensions may also forward from their own receiving group.

**Busy:**

All calls are forwarded when your extension is busy.

**No Answer:**

All calls are forwarded when you do not answer the call within a specified time period.

**Busy/No Answer (BSY/NA):**

All calls are forwarded when you do not answer within a specified time period or when your extension is busy.

**Follow Me (From):**

If you fail to set the above-mentioned "All Calls" to forward before you leave your desk, you can set the same feature from the destination extension.

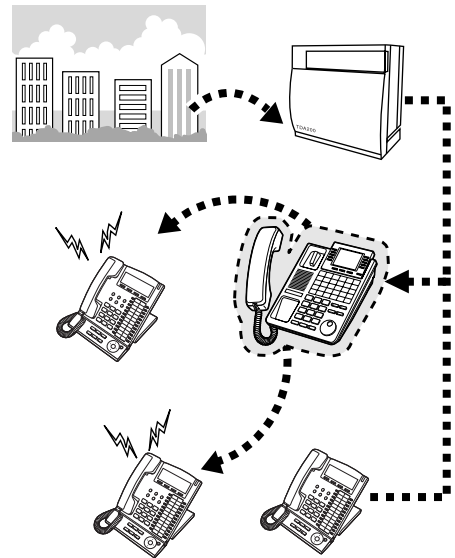

- You can set the floating extension number of a voice mail group or the SVM card as a forward destination.
- You can set your cellular phone as the forward destination.
- Incoming calls can be forwarded up to four times.
- **Boss & Secretary feature**  
The extension which has been set as the destination can call the forwarding extension.

<Example>

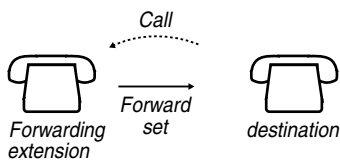

To set/cancel

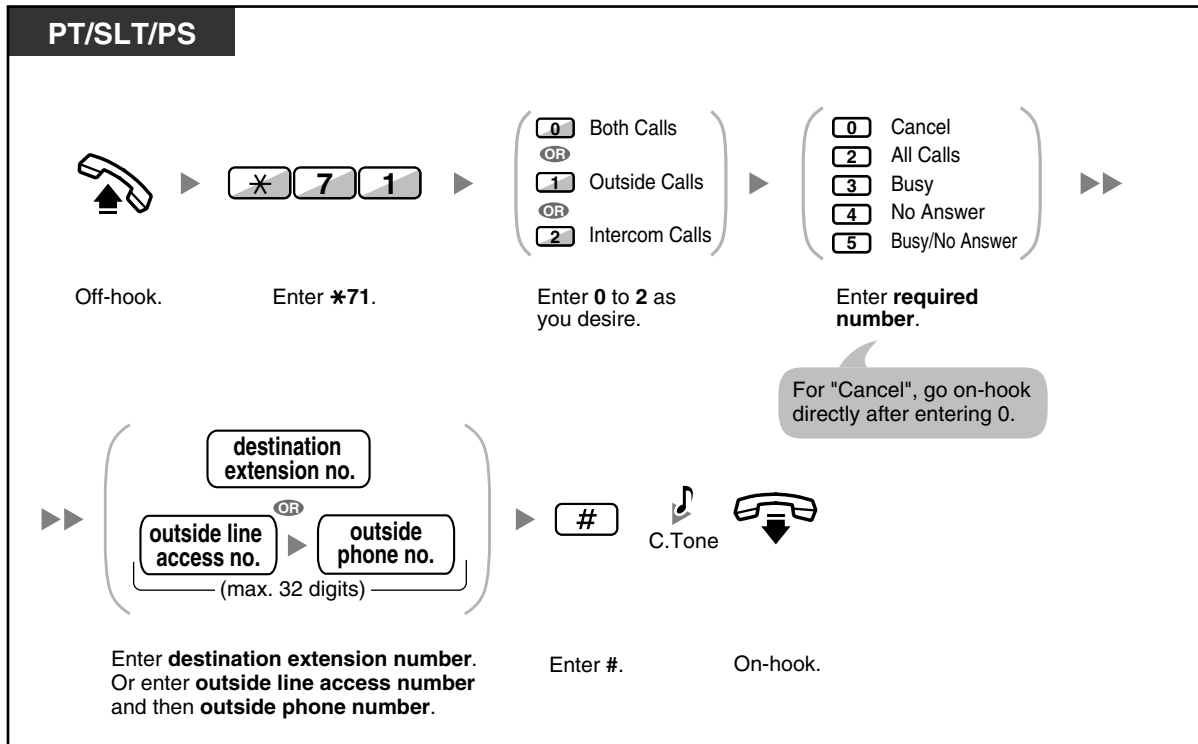

To set from another extension

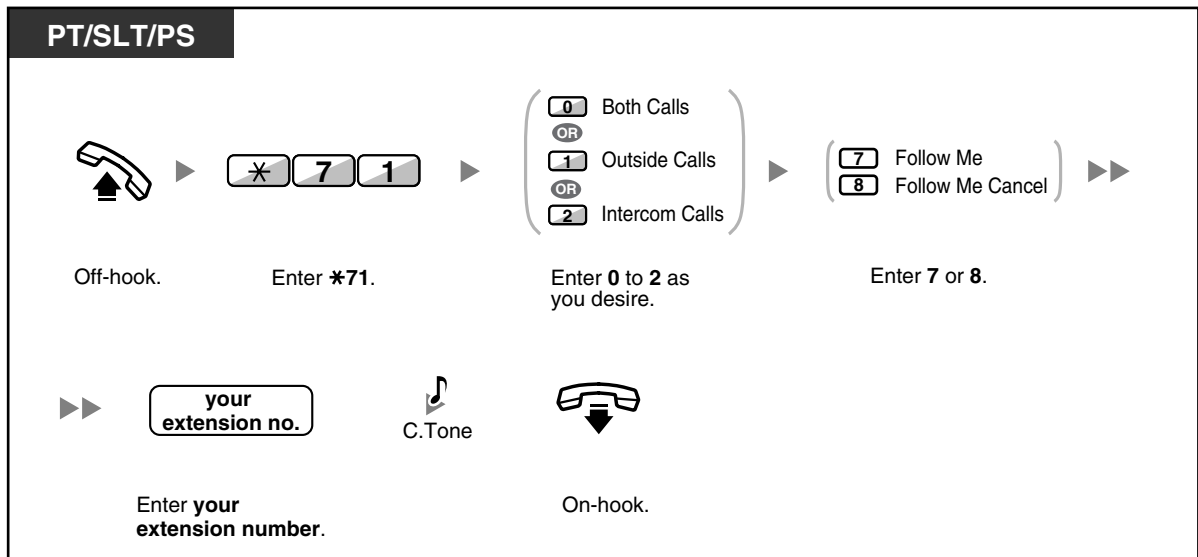

- When using a proprietary telephone, you can set or cancel Call Forwarding by pressing the FWD/DND button (fixed button) instead of "\*710".

**To set the timer for "No Answer" and "Busy/No Answer"**

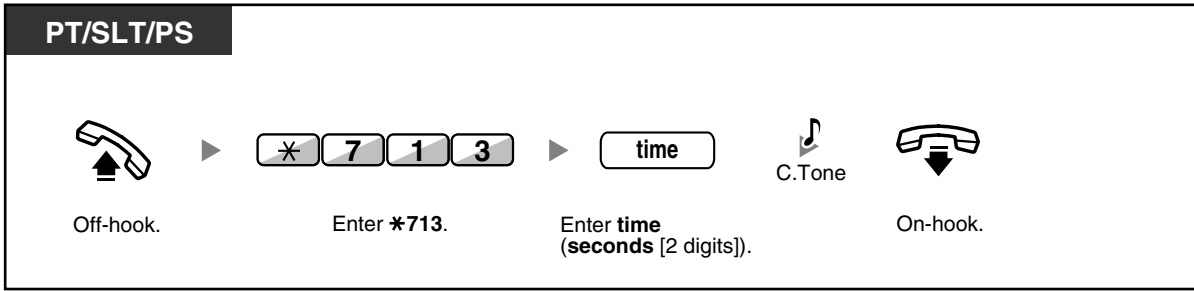

**To set/cancel (Call Forwarding [FWD] for your Incoming Call Distribution Group)**

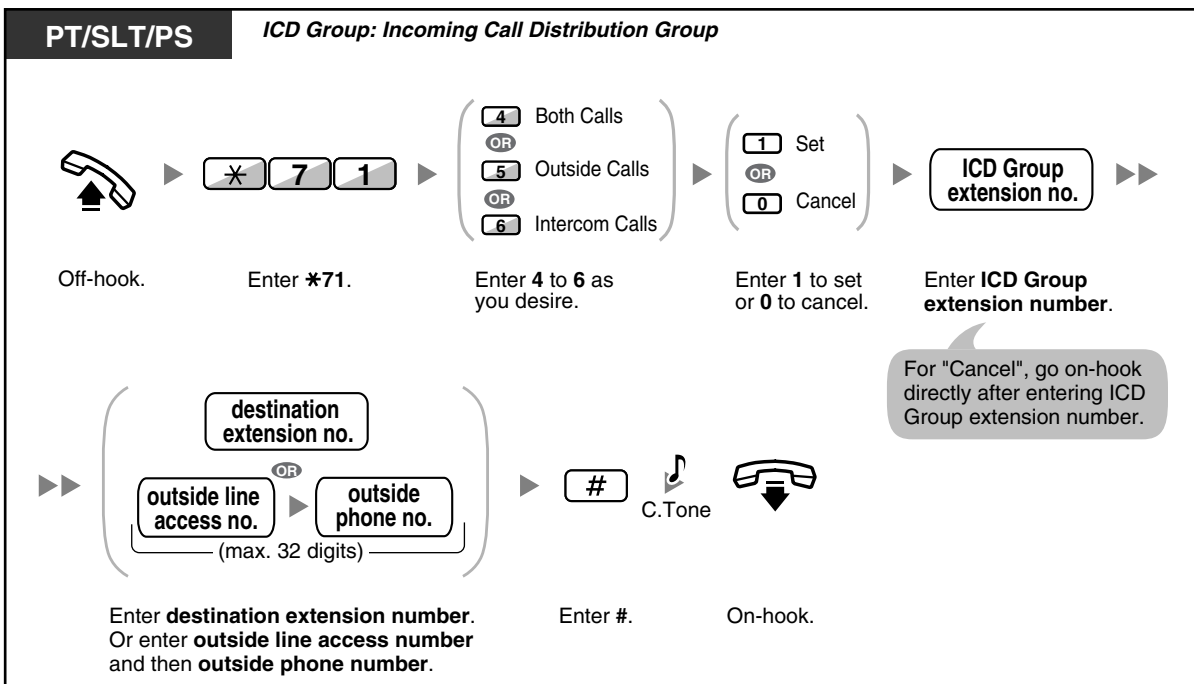

- The FWD/DND button light shows the current status as follows:  
**Off:** Both features are not set.  
**Red on:** FWD mode  
**Flashing red slowly:** DND mode
- The Group FWD button light shows the current status as follows:  
**Off:** No set  
**Red on:** FWD mode

- The system has two modes: (1) FWD/DND Cycle Switch Mode and (2) FWD/DND Setting Mode. Ask your manager what mode your system is in if you are not sure.

**(1) When in FWD/DND Cycle Switch Mode:**

Pressing the FWD/DND button (fixed button) while in idle status will cycle the setting as shown below:



**(2) When in FWD/DND Setting Mode:**

Pressing the FWD/DND button (fixed button) while in idle status allows you to switch the FWD/DND status and set the FWD destination (refer to "FWD/DND Settings Using Fixed FWD/DND Button").

**Note**

A FWD/DND button (customised button) is always in FWD/DND Cycle Switch Mode: the mode cannot be changed.

- Transferred outside calls are also forwarded to the destination assigned for outside calls.
- When intercom calls are set to be handled differently from outside calls (forwarding type, forward destination), we recommend establishing buttons for both FWD/DND—Outside calls and FWD/DND—Intercom calls, and/or Group FWD—Outside calls and Group FWD—Intercom calls, because:
  - the light patterns of the FWD/DND—Both calls button (including FWD/DND button [fixed button]) and the Group FWD—Both calls button will indicate the setting for either outside calls or intercom calls, but not both.

**Note**

The FWD icon on PS display reflects the setting for outside calls only.

- pressing the FWD/DND—Both calls button (including FWD/DND button [fixed button]) or the Group FWD—Both calls button will not change the FWD or DND mode for intercom calls and outside calls separately.



**Customising Your Phone**

- 3.1.3 Customising the Buttons  
Create or edit FWD/DND (Both calls, Outside calls, Intercom calls) buttons, or Group FWD (Both calls, Outside calls, Intercom calls) buttons.

## ◆◆ FWD/DND Settings Using Fixed FWD/DND Button

Using a proprietary telephone (PT), you can easily switch the FWD/DND status, and set the forward destination for outside/intercom calls with the FWD/DND button (fixed button). It is also possible to set outside telephone numbers (e.g., your cellular phone) as forward destinations for up to 4 Virtual PSs\* in an Incoming Call Distribution (ICD) Group, to ring together with other ICD Group members for calls to the group.



The following settings are available:

- Switching the FWD/DND status and setting FWD destination for outside/intercom calls
- Timer for "No Answer" and "Busy/No Answer"
- Forwarding status (on/off) and outside destinations to ring in parallel for outside calls for up to 4 virtual PSs in an ICD Group

### \* Virtual PS

A virtual PS is a dedicated extension number assigned to a non-existent portable station (PS) to allow access to outside destinations such as a cellular phone.

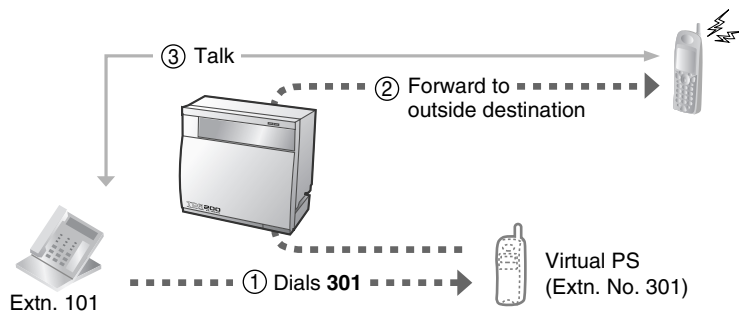

### To switch FWD/DND status for outside calls

**PT**

*While on-hook (when in FWD/DND Setting Mode)*



Press the fixed FWD/DND button.

The current FWD/DND status for outside calls is displayed.



Press the fixed FWD/DND button again to switch the status.

### To switch FWD/DND status for intercom calls

**PT**

*While on-hook (when in FWD/DND Setting Mode)*



Press the fixed FWD/DND button.

2

Enter 2.

The current FWD/DND status for intercom calls is displayed.



Press the fixed FWD/DND button again to switch the status.





- When you switch the FWD/DND status, any FWD destination that was set previously is not cleared.

**To set and clear FWD/DND for outside/intercom calls**

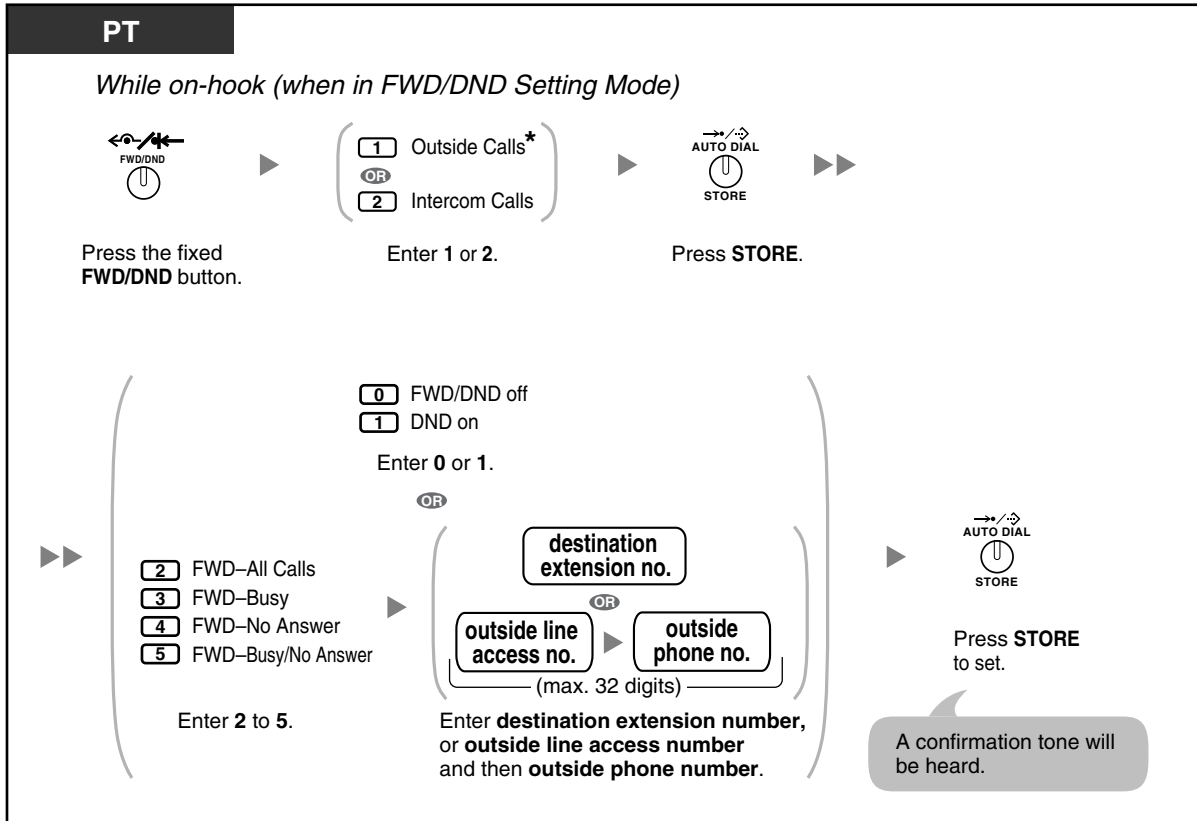

- \* This step can be omitted.

**To set the timer for "No Answer" and "Busy/No Answer"**

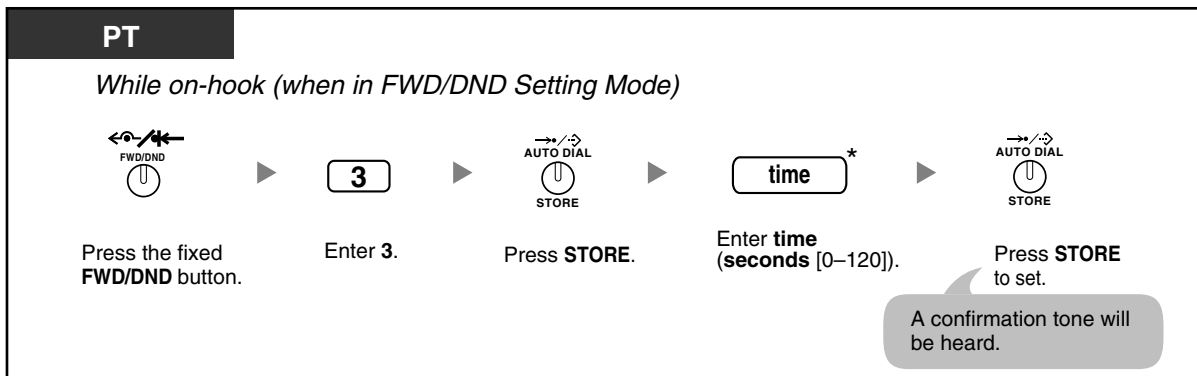

## 1.6 Before Leaving Your Desk



- \* You can enter the time as a 1–3 digit number. For example, 15 seconds can be entered as "15" or "015".

### To set forwarding status and outside destinations to ring in parallel for outside calls to an ICD Group

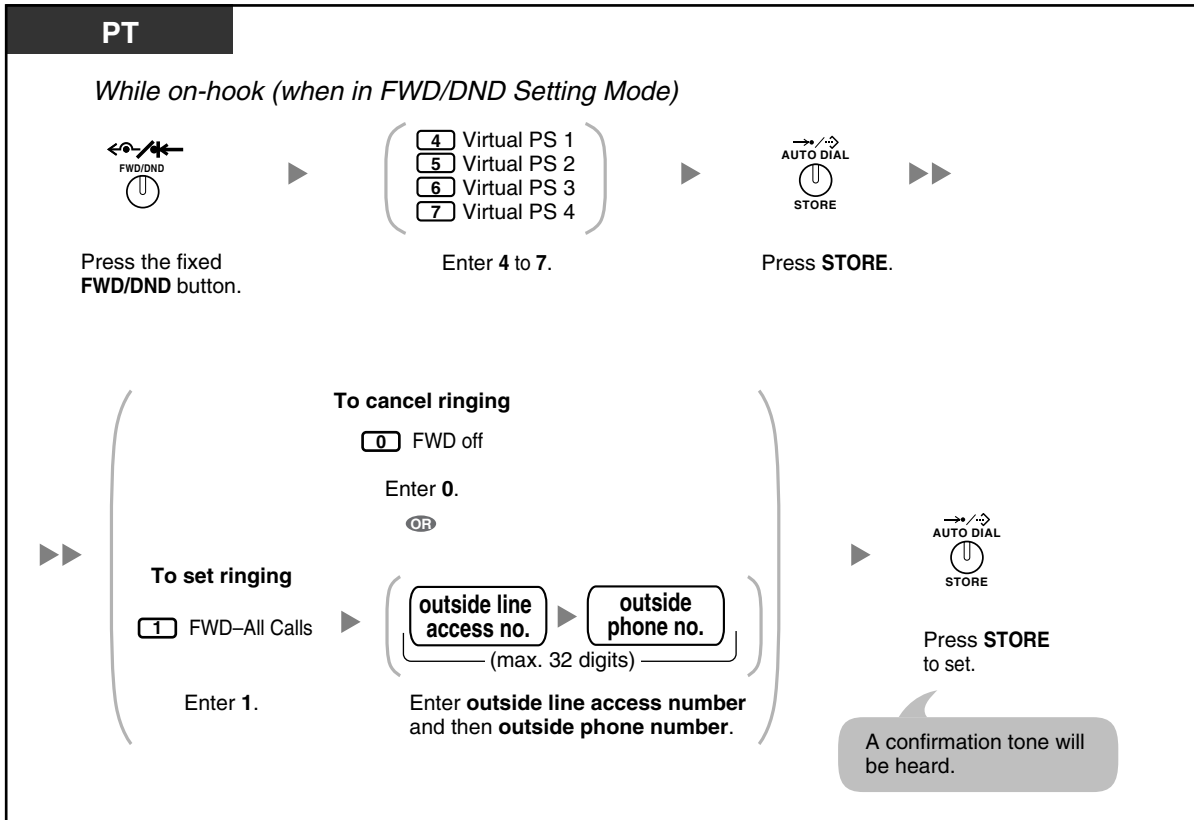

- Only one extension assigned as member 1 in each ICD group can perform the settings for virtual PSs.
- It is possible to switch the forwarding status (on/off) of a virtual PS by entering the number (4–7) of that extension, then pressing the fixed FWD/DND button, instead of pressing the AUTO DIAL/STORE button.

## ◆◆ Forwarding Your Calls Using ISDN Service (Call Forwarding [CF]—by ISDN)

All calls are forwarded to an outside party using ISDN. The following types of call forwarding are provided by the ISDN service.

- Unconditional (**Call Forwarding Unconditional [CFU]**)
- When your extension is busy (**Call Forwarding Busy [CFB]**)
- When you do not answer (**Call Forwarding No Reply [CFNR]**)

### To set

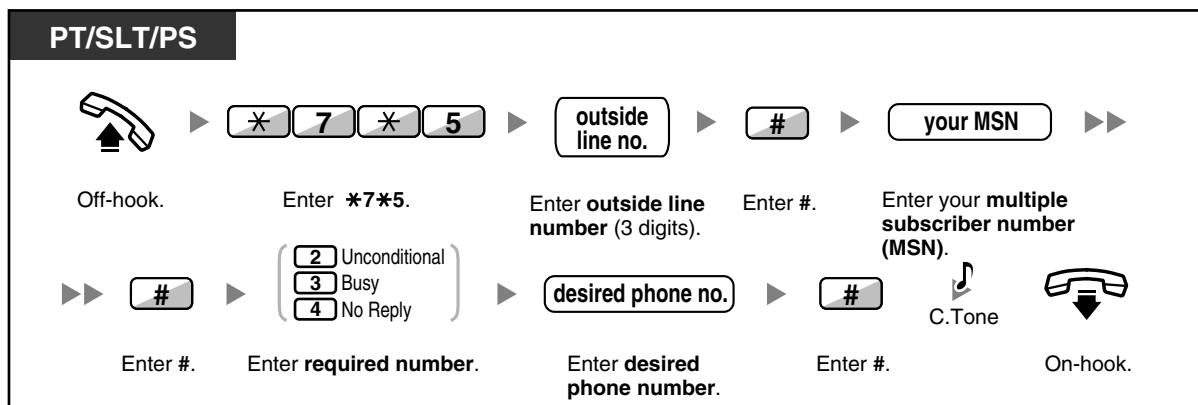

### To cancel

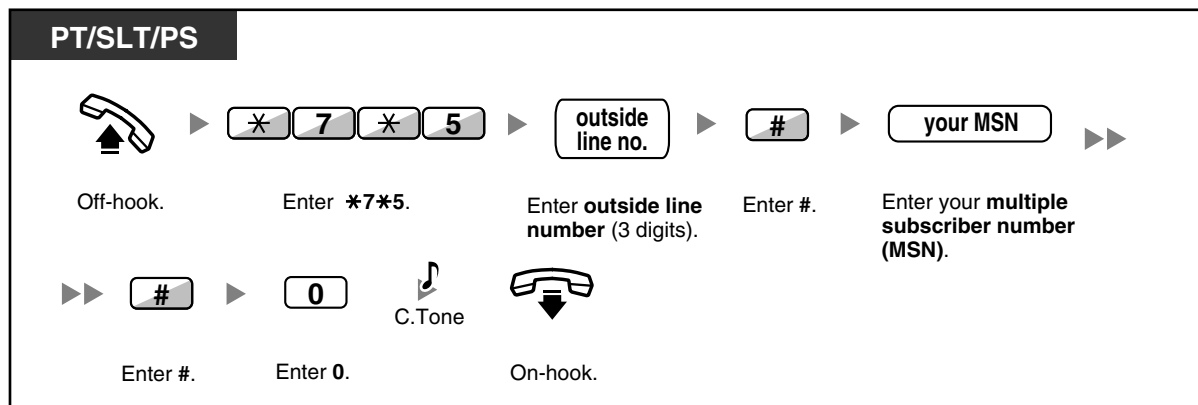

To confirm the condition

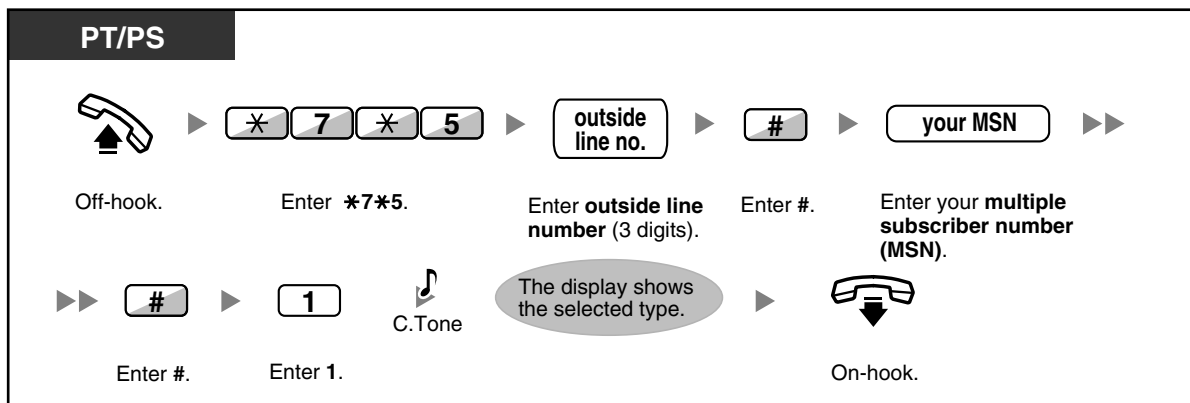

## 1.6.2 Using Voice Messaging (Built-in Simplified Voice Message [SVM]) (KX-TDA30 only)

Your PBX can provide you with answering machine service if an SVM card is installed. Your extension is assigned a message box, into which callers can leave voice messages for you. After callers reach your message box, they will hear your personal greeting message. You can record two kinds of personal greetings: a normal greeting message and a greeting message for each time mode. You can also play back and clear your greeting messages and the voice messages left by callers.

- Recording a Normal Greeting Message
- Recording a Greeting Message for Each Time Mode
- Redirecting Your Calls to Your Message Box
- Leaving Voice Messages
- Listening to Voice Messages Left by Callers
- Accessing Your Message Box from an Outside Telephone
- Accessing the Message Box of Another Extension from Your Extension



- You may hear a busy tone when trying to access your message box if too many other users are already accessing their message boxes. In that case, wait a few minutes and try again.
- If the used recording space (including greeting messages and voice messages left by callers) for the SVM card reaches a certain limit, the display informs you that the recording space is almost full, and you will hear dial tone 3 when going off-hook.

### Dial Tone 3



- **Operation Reference When Accessing Your Message Box**  
After entering the SVM feature number (\*38), the operations below are available by entering the corresponding numbers.

Operation No.	Operation
<input type="text" value="0"/>	To clear the normal greeting message
<input type="text" value="1"/>	To record a normal greeting message
<input type="text" value="2"/>	To play back the normal greeting message
<input type="text" value="3"/>	To listen to voice messages left by callers
<input type="text" value="8"/>	To set a greeting message for each time mode
<input type="text" value="#"/> <input type="text" value="6"/>	To leave a voice message to another extension's message box

## ◆◆ Recording a Normal Greeting Message

### To record

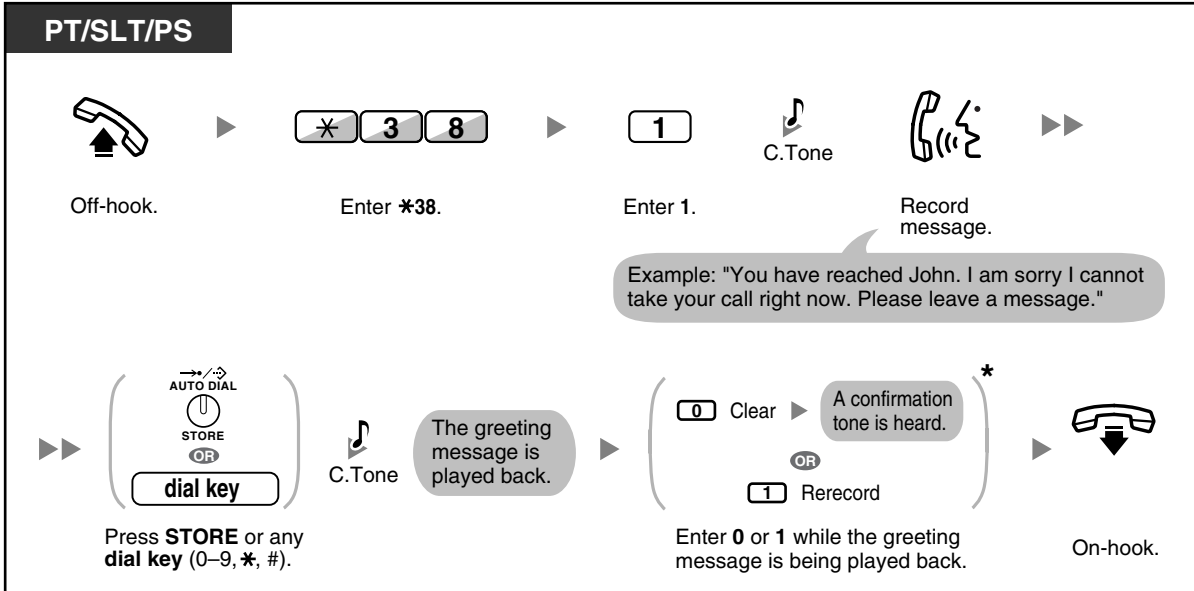

### To play back

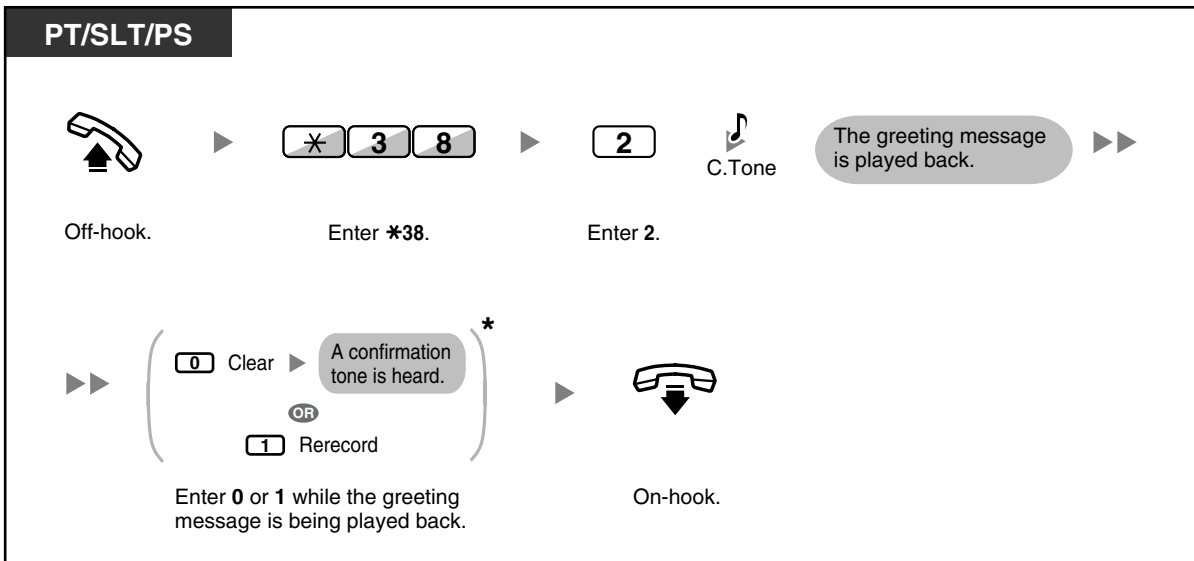

- \* This step can be omitted.

To clear

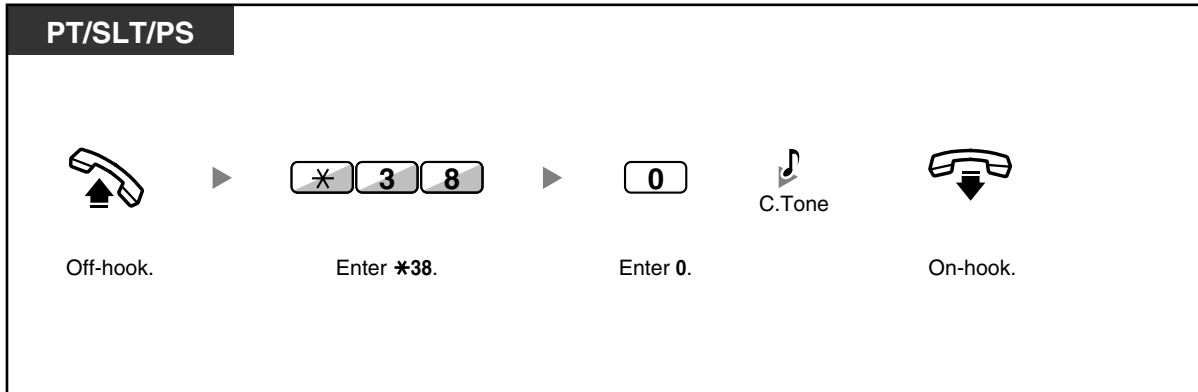

◆◆ Recording a Greeting Message for Each Time Mode

In addition to a normal greeting message, you can record a specific greeting message for each time mode (day/lunch/break/night).

To record

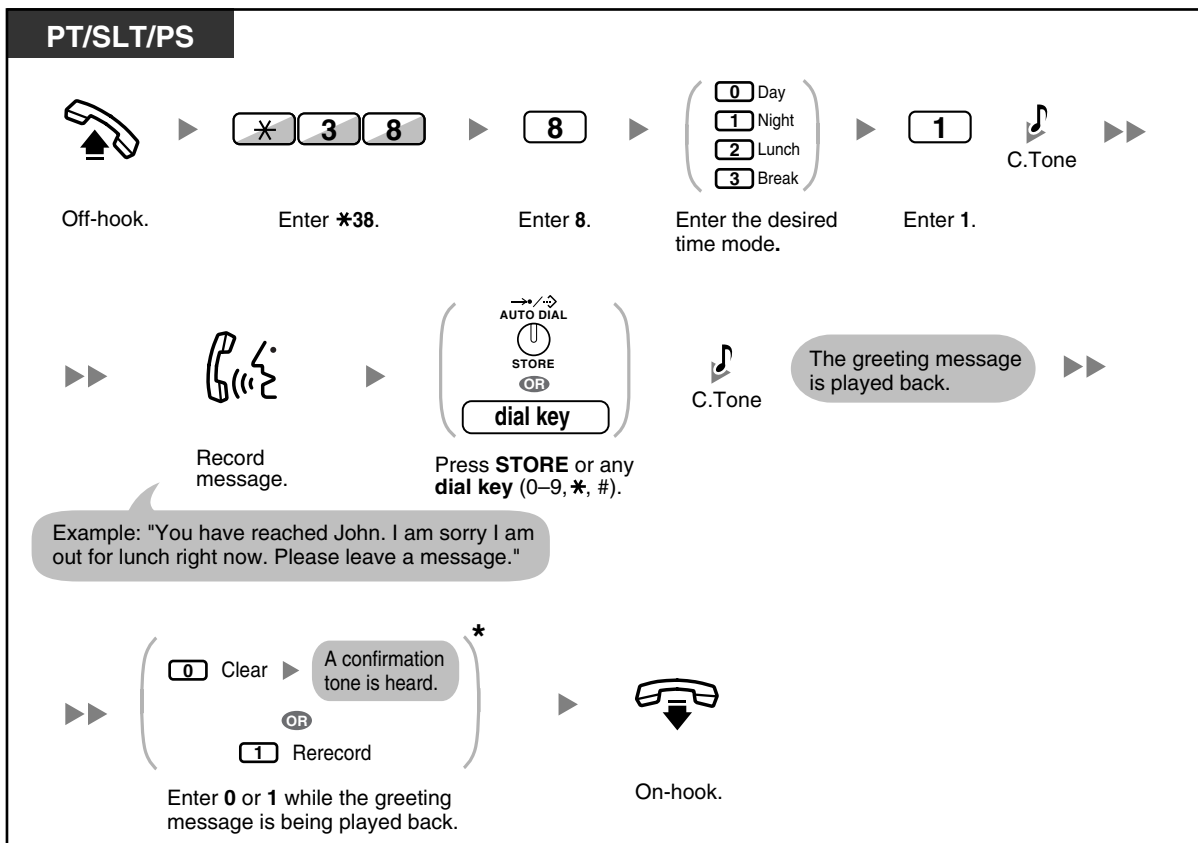

To play back

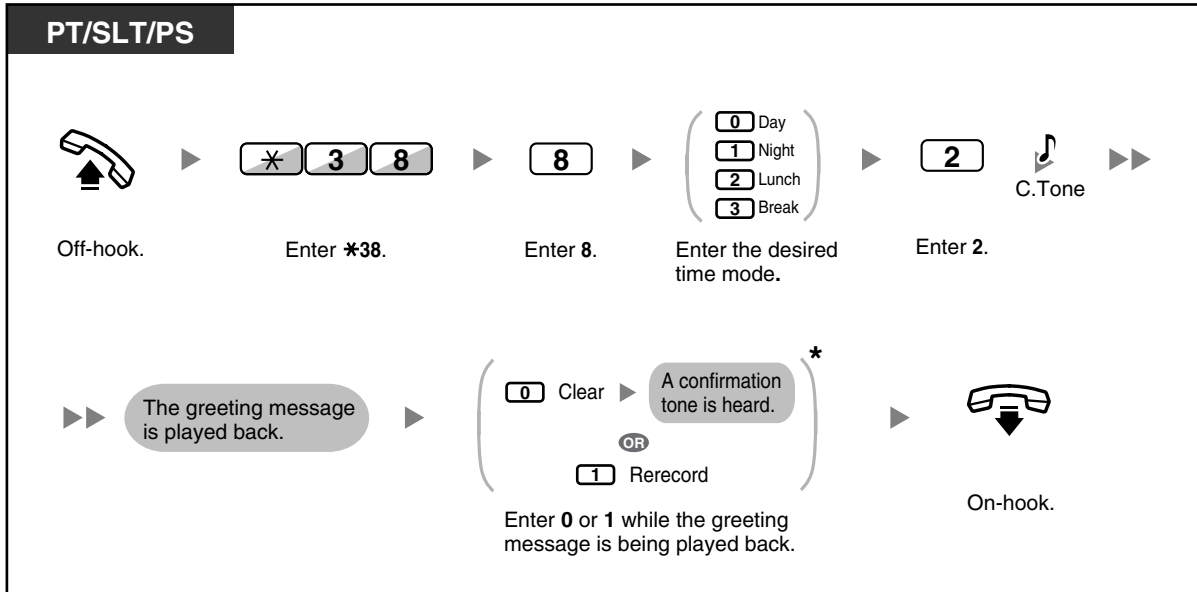

- \* This step can be omitted.

To clear

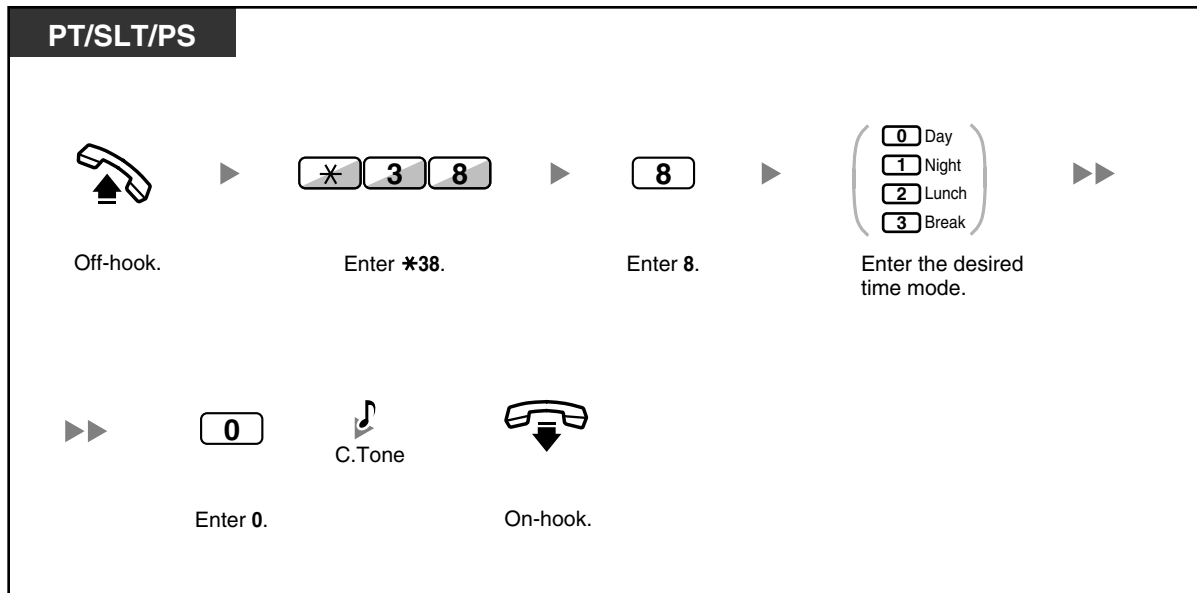

- If both the greeting message for a certain time mode and the normal greeting message have been recorded, callers will hear the greeting message for that time mode. However, if no greeting message has been recorded for a certain time mode, the normal greeting message will be played instead.



## ◆◆ Redirecting Your Calls to Your Message Box

You can set incoming calls to be redirected to your own message box so that callers can leave voice messages when you cannot answer the phone.

### To set/cancel

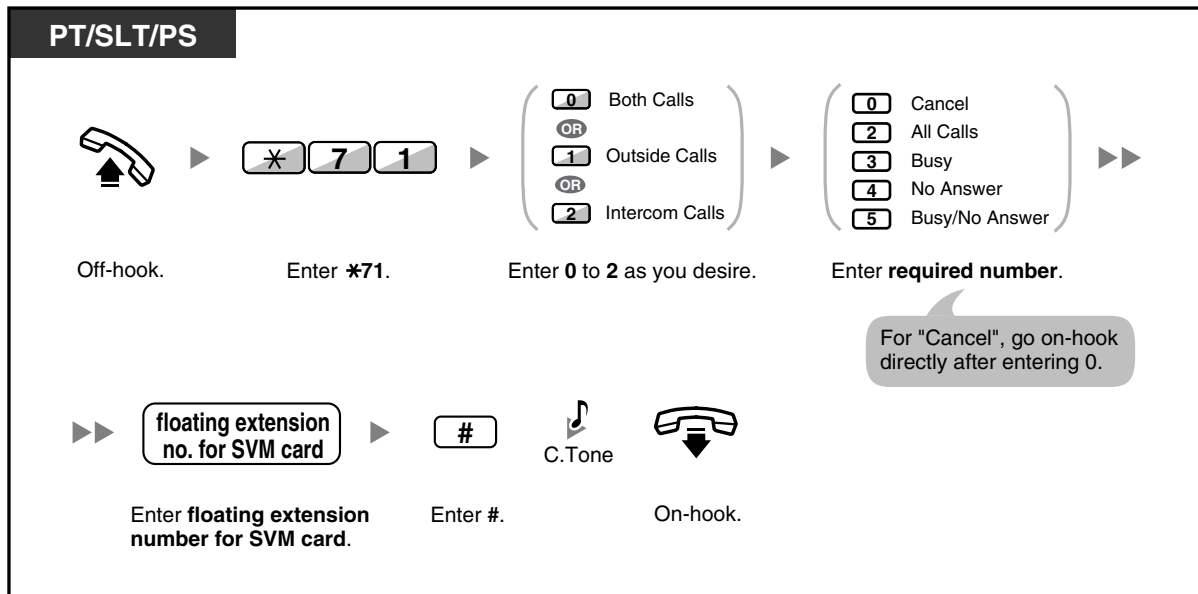

- The default floating extension numbers are 591 for SVM card 1, and 592 for SVM card 2.

### ◆◆ Leaving Voice Messages

If the extension user you called is not able to answer your call, and your call is redirected to the message box, you will hear the greeting message. Then, you can leave a voice message for that extension. It is also possible to leave a voice message directly in the message box of a desired extension by following the steps below:

#### To leave a voice message directly to another extension's message box

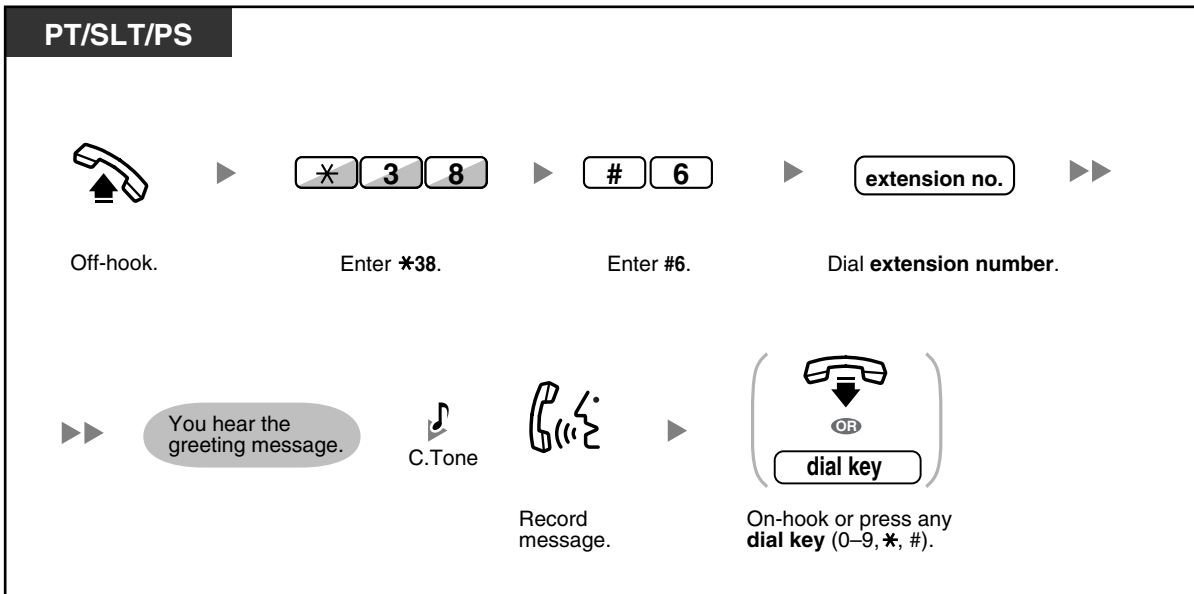

- Voice message recording will stop, you will hear a notification tone, and the call will be disconnected, in the following cases:
  - a. the recording time for the voice message reaches the preprogrammed limit. (default: 120 seconds)
  - b. the recording space for the SVM card reaches the limit.



- When you are on the phone, you can transfer the call directly to the message box of a desired extension by placing the call on hold temporarily, then pressing \*38 + #6 + the desired extension number. This allows the caller to leave a voice message in the message box of the desired extension.

## ◆◆ Listening to Voice Messages Left by Callers

When a caller leaves a voice message, information about that caller is also recorded as the SVM Log. The SVM Log can be viewed using the display of a PT or PS by pressing the Message button.

### To listen to voice messages

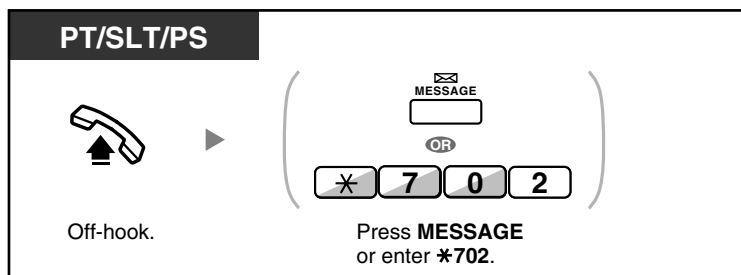
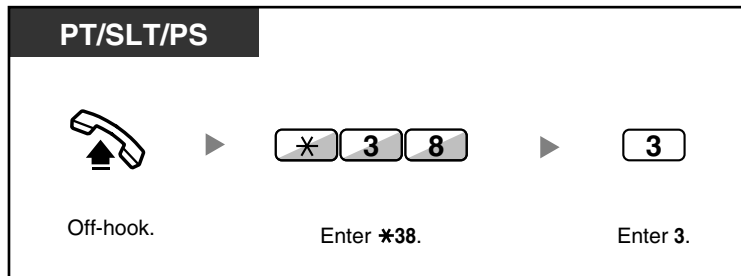
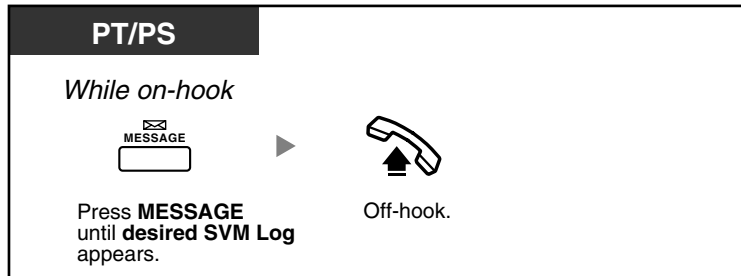

### To clear the voice message that you are listening to

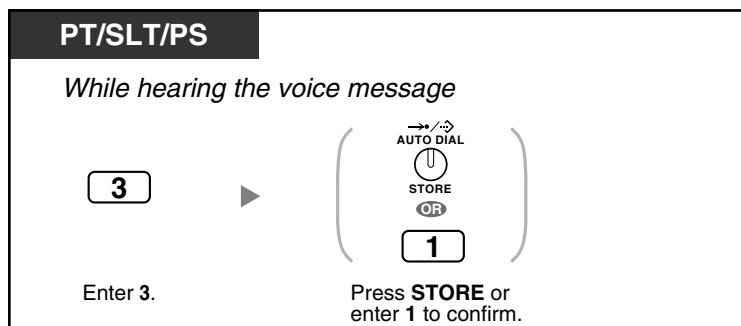

## 1.6 Before Leaving Your Desk



- Various operations are available by entering numbers while you are listening to a recorded voice message using any of the methods described above. The available options are as follows:

Operation No.	Operations
<b>1</b> / <b>#</b> <b>*</b>	To play back the voice message from the beginning
<b>2</b>	To go to the next voice message
<b>3</b>	To clear the voice message (Press the AUTO DIAL/STORE button or enter 1 to confirm.)
<b>4</b>	To call back the caller who left the voice message
<b>5</b>	To go back to the previous voice message
<b>#</b> <b>6</b>	To leave a voice message directly in the message box of another extension (Enter desired extension number.)
<b>#</b> <b>8</b>	To play back your greeting message and record a voice message in your own message box
<b>#</b> <b>9</b>	To end the call

- In addition to the caller information that is recorded in the Call Log, the following SVM Log information is recorded with voice messages left by callers:
  - Caller's Name
  - Caller's Telephone Number
  - Time recording started
  - Voice Message Status
    - "New" is displayed for voice messages that have not previously been listened to.
    - "Old" is displayed for voice messages that have previously been listened to.

Please note that the information shown on the display may vary depending on the information that was received and the type of telephone used. Only users of a 6-line display PT can view all of the above information.

- You can lock the SVM Log display by using an extension PIN (Personal Identification Number) to prevent other users from viewing the information and from playing back your voice messages (Display Lock). Refer to "3.1.2 Settings on the Programming Mode".
- If your telephone has a Message for Another Extension button, you can access the message box of another extension and listen to voice messages for that extension.
- If a new voice message has been left in your message box, you will hear dial tone 4 after going off-hook. In addition, if your telephone has a Message button or Message/Ringer Lamp, the corresponding button or lamp will light when a voice message has been left.

### Dial Tone 4



**To listen to voice messages while your display is locked**

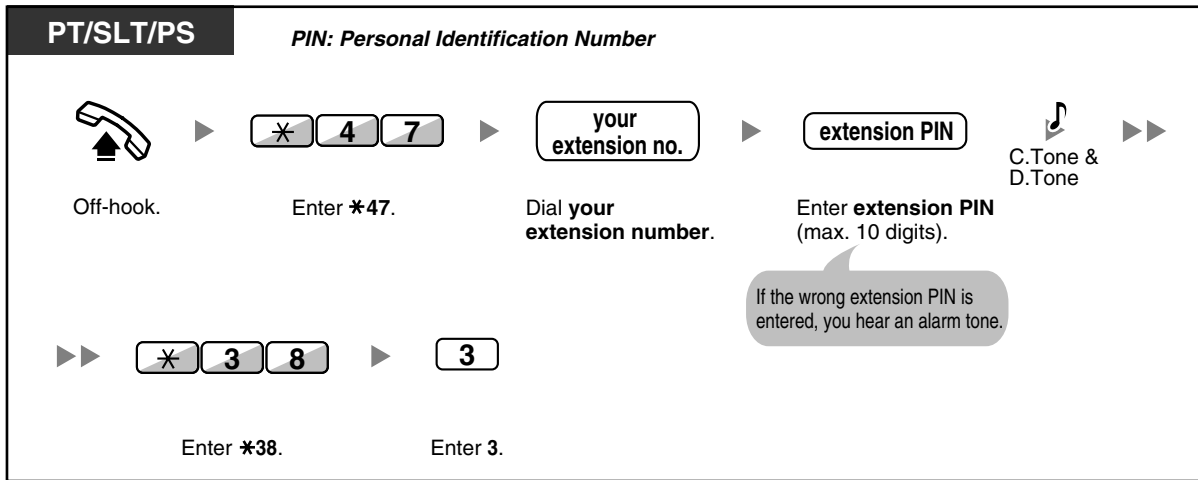

- When you press the Message button while on-hook to play back voice messages, Display Lock is temporarily deactivated.

**To clear voice messages from the SVM Log**

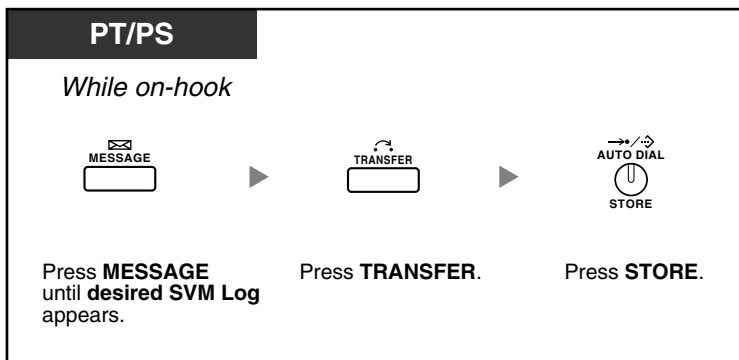

## ◆◆ Accessing Your Message Box from an Outside Telephone

You can remotely access your message box and perform any operations of the SVM feature through an outside line as if you were at your own extension.

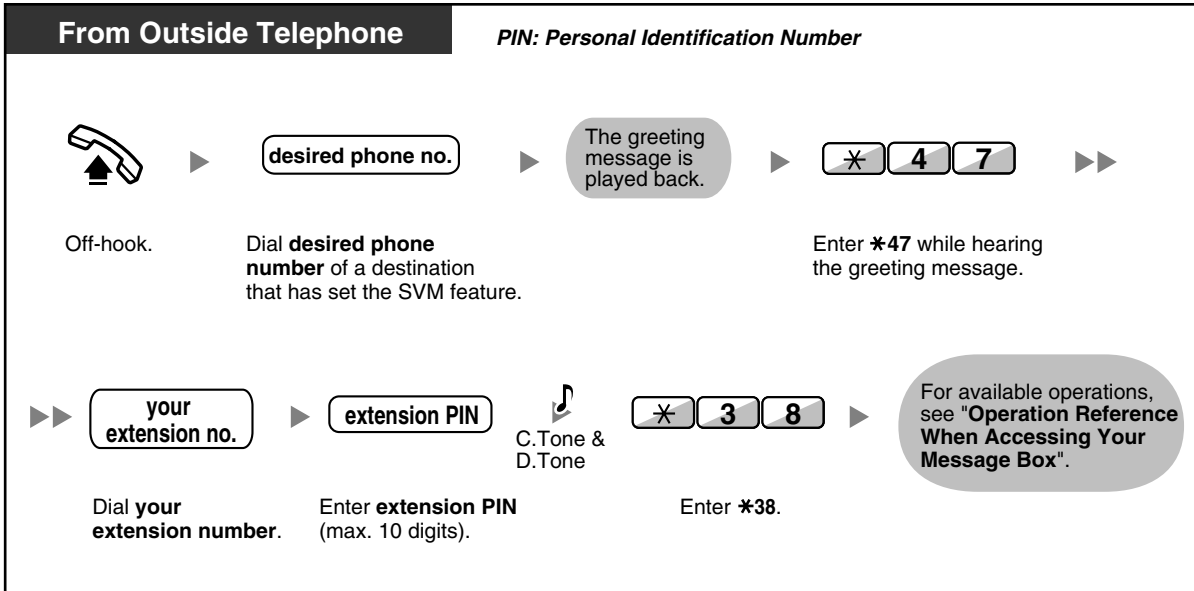

- If you hear a reorder tone when you try to leave a voice message directly in the message box of another extension, that message box is unavailable. You can enter another extension number by pressing "\*".
- When accessing your message box from an outside telephone, you cannot call back callers who have left voice messages, by pressing 4 while hearing the voice message.

### To listen to voice messages left in the message box of another extension

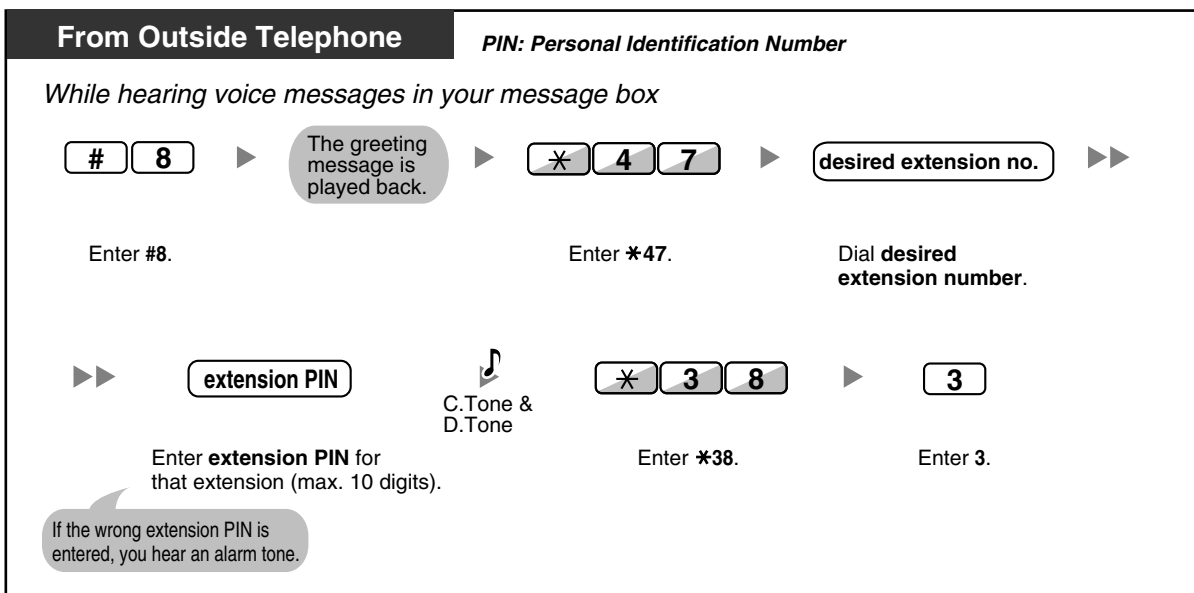

## ◆◆ Accessing the Message Box of Another Extension from Your Extension

You can access the message box of another extension (for example, to record a greeting message for that extension) by following the steps below:

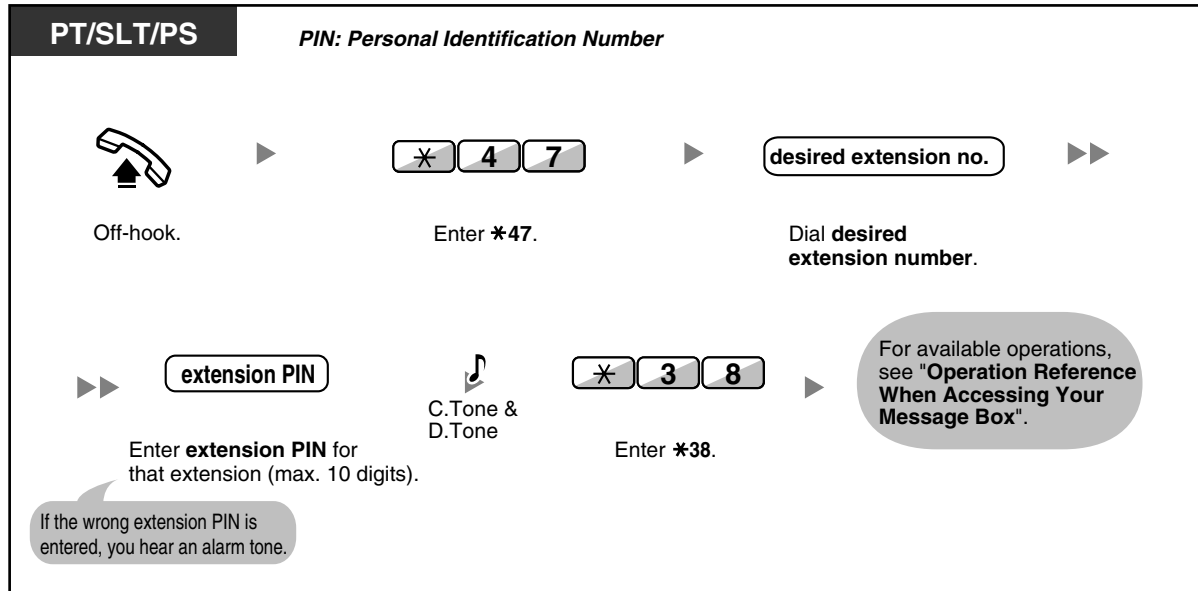

### 1.6.3 Showing a Message on the Caller's Telephone Display (Absent Message)

You can show the reason you do not answer, if the caller uses a Panasonic display proprietary telephone. There are eight preprogrammed messages and one for your personal message (16 characters). The selected message is shown on the display of your telephone.

Message no.	Message (Example)
1	Will Return Soon
2	Gone Home
3	At Ext %%% (Extension number)
4	Back at %:% (Hour:Minute)
5	Out until %/% (Month/Day)
6	In a Meeting
7	
8	
9	A message assigned for each extension. (Personal Absent Message)

**To set**

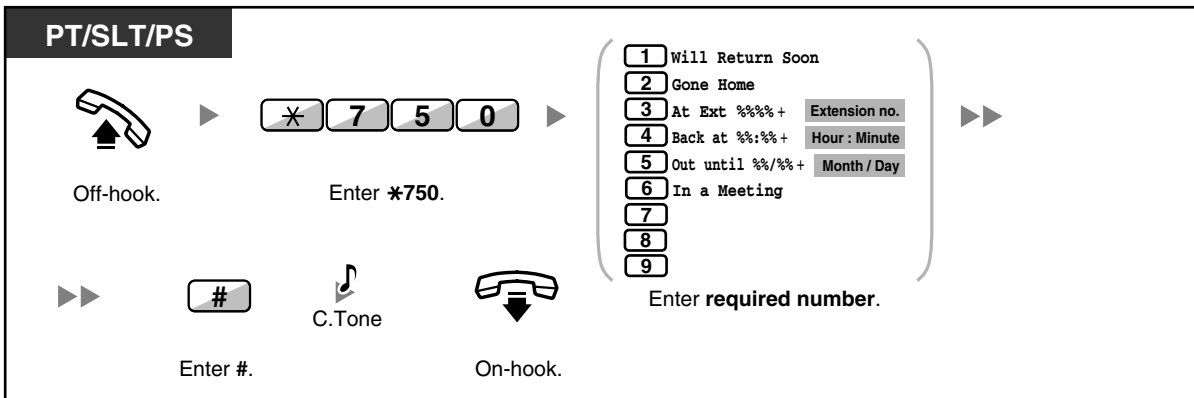

**To cancel**

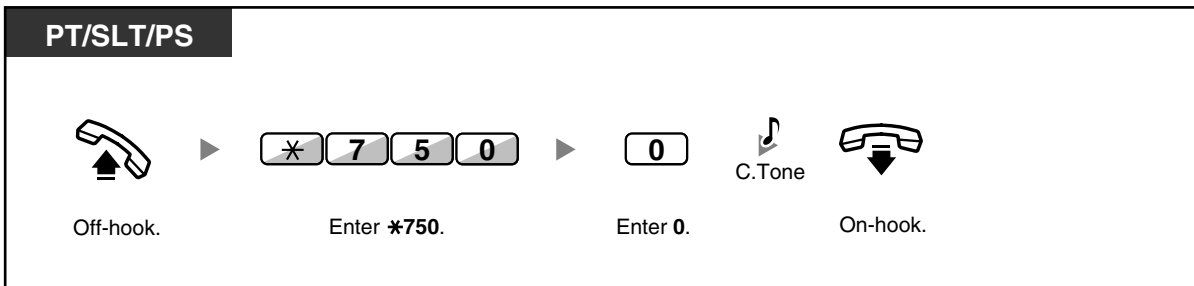





- Enter the desired value in the "%" positions. You must enter the correct number of characters as represented by the "%" using 0 to 9 or ✖.
- The preprogrammed messages can be changed through system programming.
- To create your personal message (Message no. 9), refer to "3.1.2 Settings on the Programming Mode".

## 1.6.4 Preventing Other People from Using Your Telephone (Extension Dial Lock)

You can lock your extension so that other users cannot make inappropriate outside calls. This feature is also known as Electronic Station Lockout.

### To lock

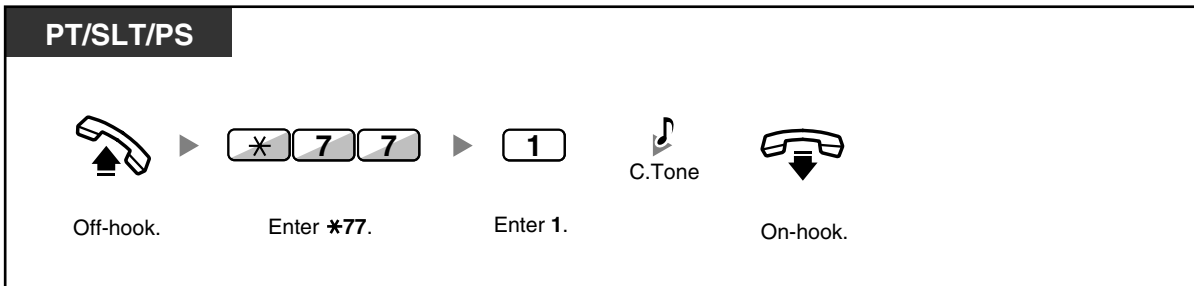

### To unlock

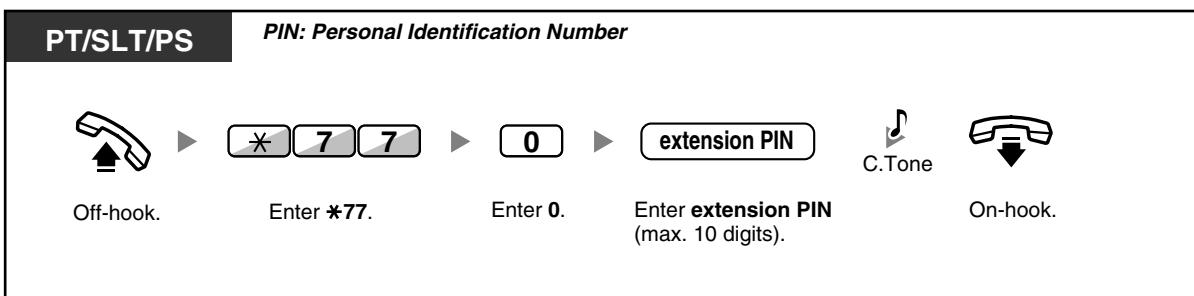

- **If you forget the extension PIN or cannot unlock your extension**, consult your manager. He can clear your extension PIN. Then, you can set the new PIN and unlock your extension by entering it.
- If your extension is locked by this feature, it cannot perform features as follows:
  - Making outside calls
  - Changing the call forwarding destination
- If you do not set extension PIN, you cannot lock and unlock your extension.

### To make an outside call while your extension is locked

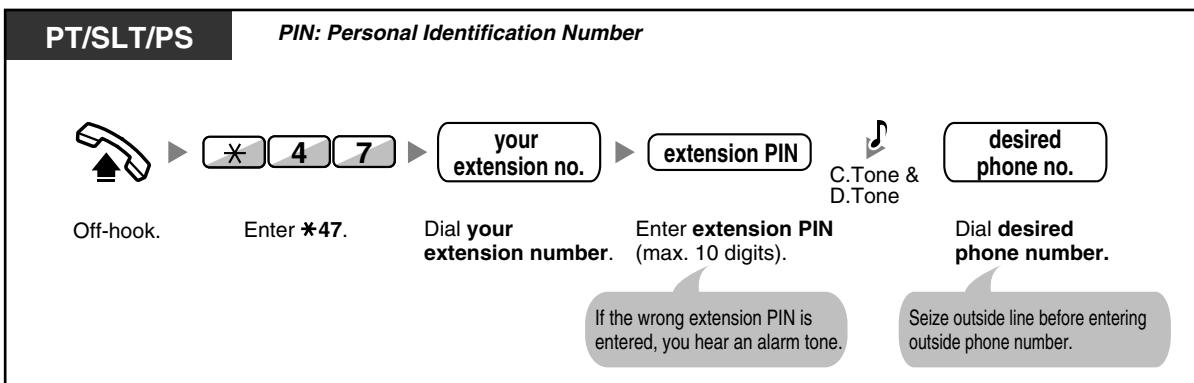



- After you make an outside call, Extension Dial Lock is automatically activated again.

# 1.7 Making/Answering an Announcement

## 1.7.1 Paging

- Group Paging
- Paging and then Transferring a Call

### ◆◆ Group Paging

You can make a voice announcement to proprietary telephones or external speakers or both in the preset group simultaneously.

#### To page

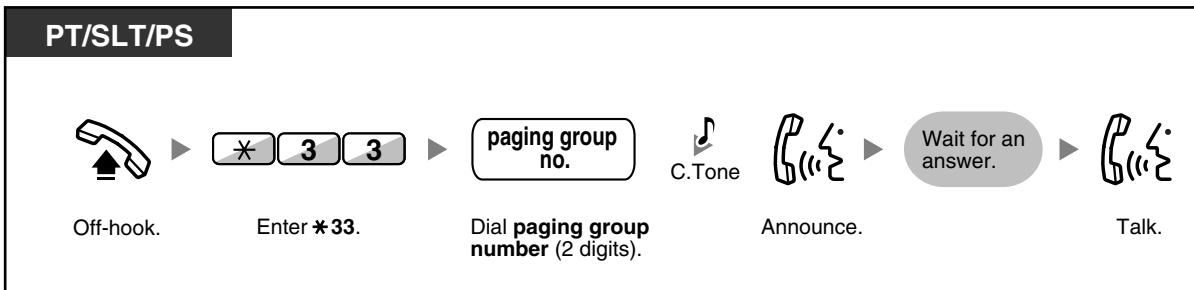

- If the group which you paged is already being used for paging, you hear a busy tone.

### ◆◆ Paging and then Transferring a Call

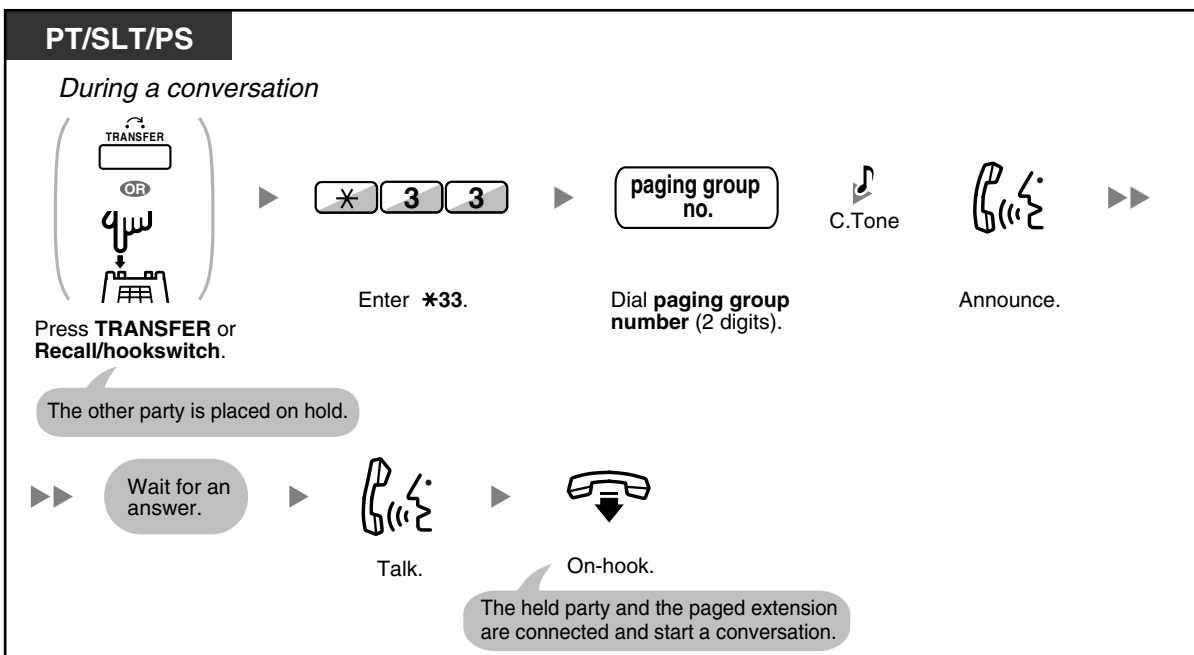



- After you go on-hook, the caller can talk to the person who answers the page.

## 1.7.2 Answering/Denying a Paging Announcement

To answer

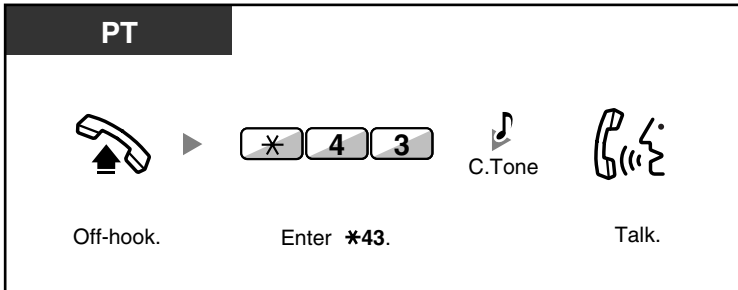

To allow/deny a paging announcement (Paging Deny)

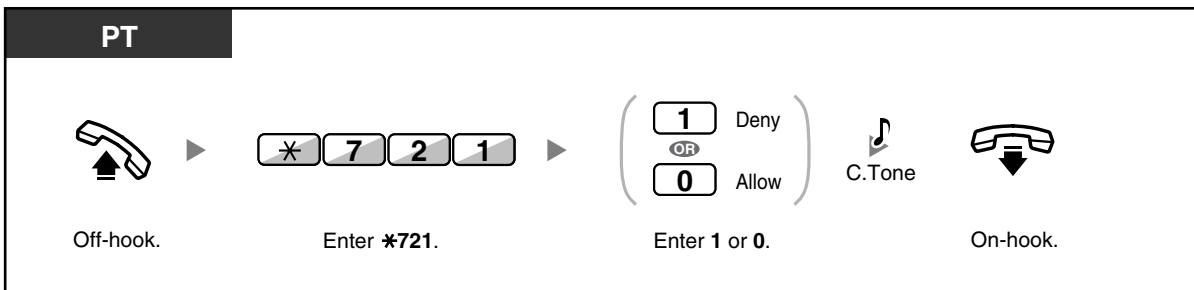

- The following are extensions that cannot receive a paging announcement:
  - Portable station
  - Single line telephone
  - Proprietary telephone that is ringing or busy
  - Proprietary telephone in Paging Deny mode
  - Proprietary telephone in DND mode
- Even if the announcement is not paging your extension, you can answer it, if it is paging your group.

### 1.7.3 Making an Announcement and Having a Multiple Party Conversation (Broadcasting)

You can call multiple parties assigned in the group and make a voice announcement. You can also establish a multiple party conversation with called parties. This conversation will be heard by other called parties. Called parties can listen to the announcement simply by going off-hook. They can send a notification tone if they want to join the conversation.

#### To make/answer a broadcasting call

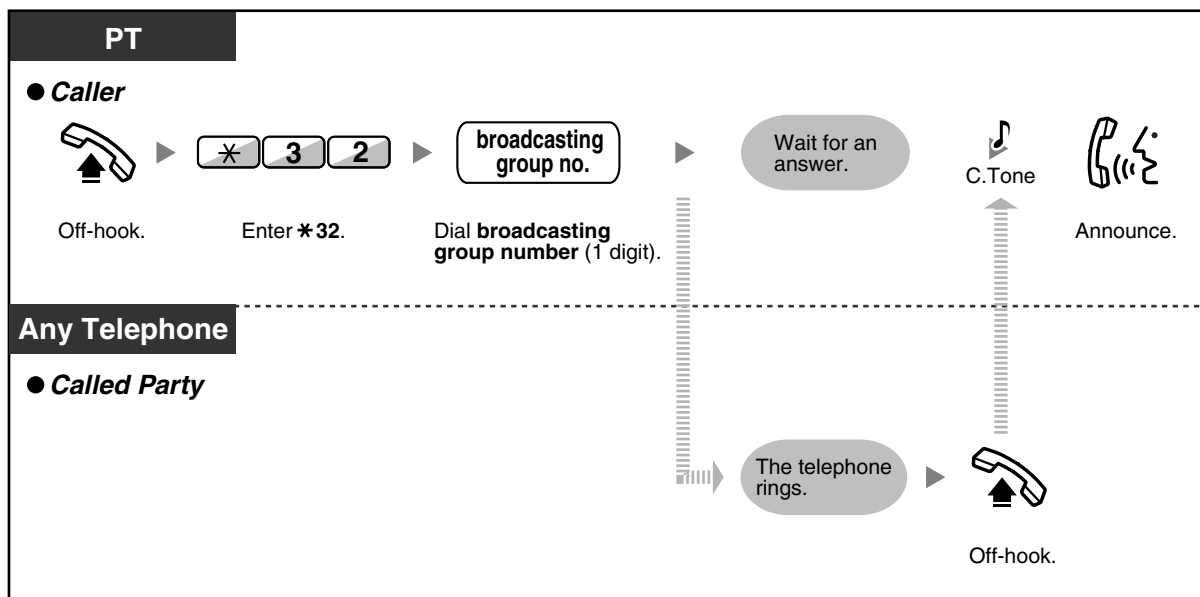

#### ◆ For a caller

#### To make a conversation with a specific party

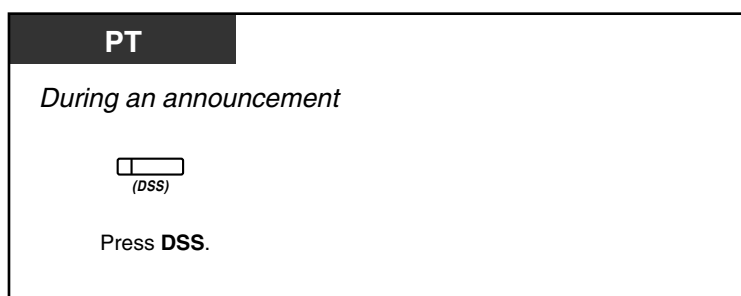

**To make a conversation with a party in the group's preassigned order**

**PT**

*During an announcement*





Press **CONF**.

**To end a conversation with a specific party**

**PT**

*During a conversation*

- **To end a conversation with a specific party**  

Press **DSS**.
- **To end a conversation with the party who joined the conversation last**  

Press **TRANSFER**.
- **To disconnect the party who joined the conversation last from the broadcast**  

Press **FLASH/RECALL**.



- In this case, the FLASH/RECALL button must be set to Flash/Recall mode through system programming.



◆ For a called extension

To send a notification tone to the caller and join a conversation

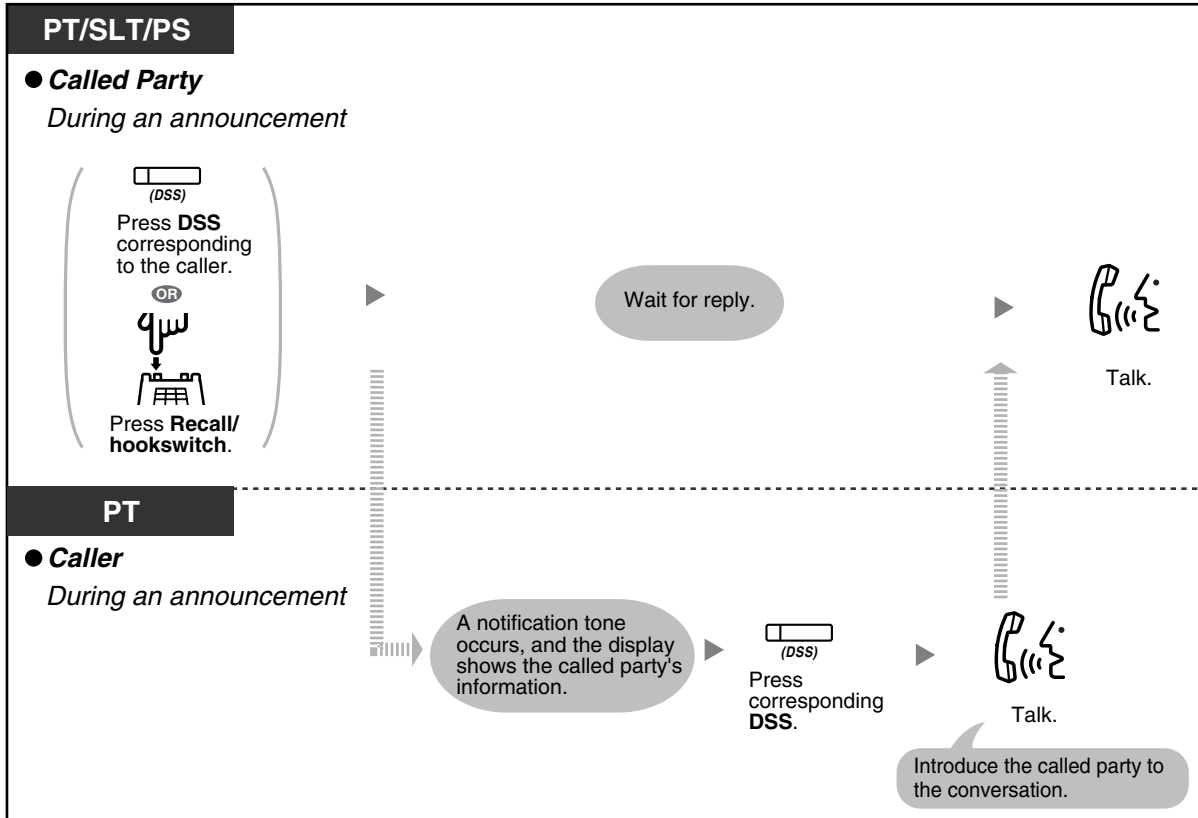

- A conversation can be established with a maximum of 4 parties (including the caller).

# 1.8 Setting the Telephone According to Your Needs

## 1.8.1 Setting the Alarm (Timed Reminder)

You can receive an alarm at your telephone to remind you of a meeting, appointment or as a wake-up call. The alarm can occur either once or daily (every day until cancelled) at a preset time. When you go off-hook to answer, you will hear a special dial tone or prerecorded message.

**To set**

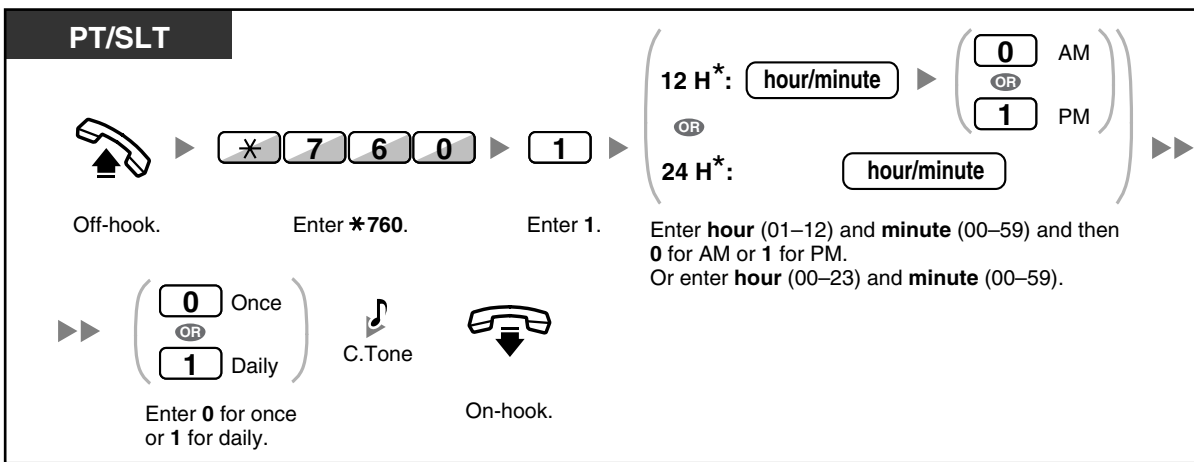

- \* Enter the time in the format assigned to your PBX (12-hour or 24-hour).

**To cancel**

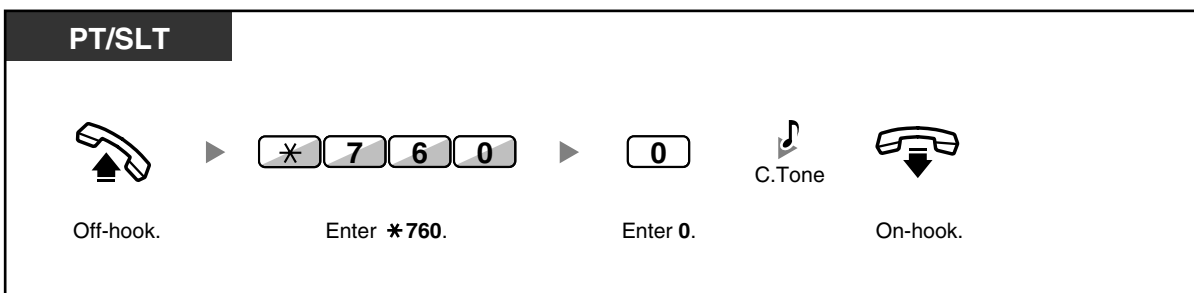

### To stop or answer the ringback

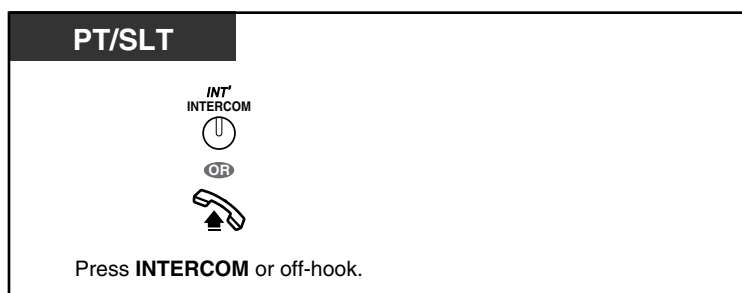

### To confirm

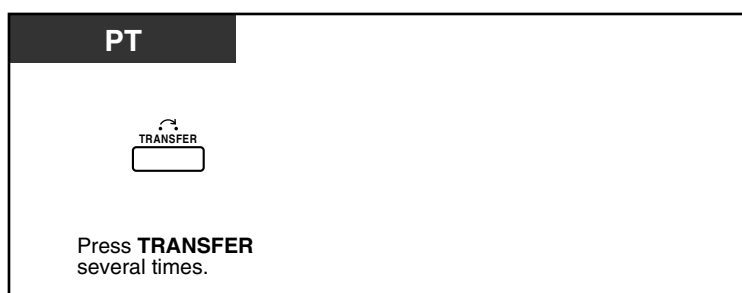

- You can also confirm the Timed Reminder by using the soft button.
- The alarm keeps ringing for preprogrammed seconds.
- **If you receive an incoming call during ringback**, the ringing starts after the ringback stops.
- **If you are having a conversation exceeding alarm ringing period**, the ringback will start after your conversation.

## 1.8.2 Refusing Incoming Calls (Do Not Disturb [DND])

- Do Not Disturb (DND)
- Switching FWD/DND Status Using Fixed FWD/DND Button

### ◆◆ Do Not Disturb (DND)

You can set this feature to prevent incoming calls from ringing at your extension. This can be useful, for example, when you are in a meeting or busy.

#### To set/cancel

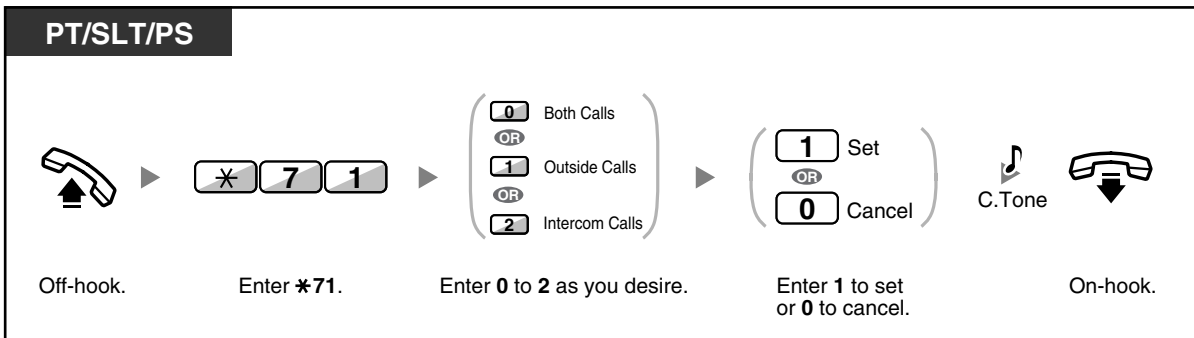

- When using a proprietary telephone, you can set or cancel Do Not Disturb by pressing the FWD/DND button (fixed button) instead of "\*710".



- The FWD/DND button light shows the current status as follows:  
**Off:** Both features are not set.  
**Red on:** FWD mode  
**Flashing red slowly:** DND mode
- The system has two modes: (1) FWD/DND Cycle Switch Mode and (2) FWD/DND Setting Mode. Ask your manager what mode your system is in if you are not sure.

**(1) When in FWD/DND Cycle Switch Mode:**

Pressing the FWD/DND button (fixed button) while in idle status will cycle the setting as shown below:



**(2) When in FWD/DND Setting Mode:**

Pressing the FWD/DND button (fixed button) while in idle status allows you to switch the FWD/DND status and set the FWD destination (refer to "Switching FWD/DND Status Using Fixed FWD/DND Button").

**Note**

A FWD/DND button (customised button) is always in FWD/DND Cycle Switch Mode: the mode cannot be changed.

- If your extension has set this feature, a calling extension will hear DND tone.
- If this feature is set, the Call Forwarding (FWD) feature does not work.
- Specified extensions can override this feature and call DND extensions (DND Override).
- When making a call using an SDN button to a PDN extension with DND set, this feature will temporarily be deactivated.
- When intercom calls are set to be handled differently from outside calls (DND set/cancel), we recommend establishing buttons for both FWD/DND—Outside calls and FWD/DND—Intercom calls, because:
  - the light patterns of the FWD/DND—Both calls button (including FWD/DND button [fixed button]) will indicate the setting for either outside calls or intercoms calls, but not both.

**Note**

The DND icon on PS display reflects the setting for outside calls only.

- pressing the FWD/DND—Both calls button (including FWD/DND button [fixed button]) will not change the FWD or DND mode for intercom calls and outside calls separately.



**Customising Your Phone**

- 3.1.3 Customising the Buttons  
 Create or edit FWD/DND (Both calls, Outside calls, Intercom calls) buttons.

## ◆◆ Switching FWD/DND Status Using Fixed FWD/DND Button

Using a proprietary telephone (PT), you can easily switch the FWD/DND status for outside/intercom calls without clearing any FWD destination that was set previously.



## 1.8 Setting the Telephone According to Your Needs

### To switch the FWD/DND status for outside calls

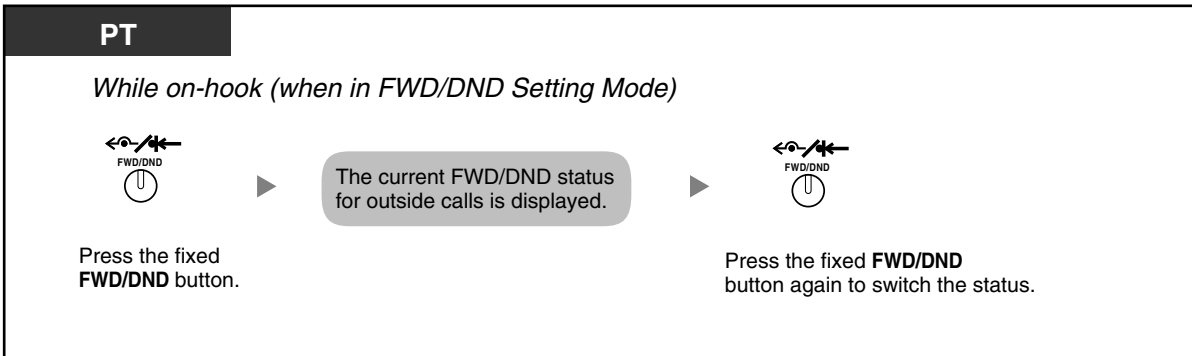

### To switch the FWD/DND status for intercom calls

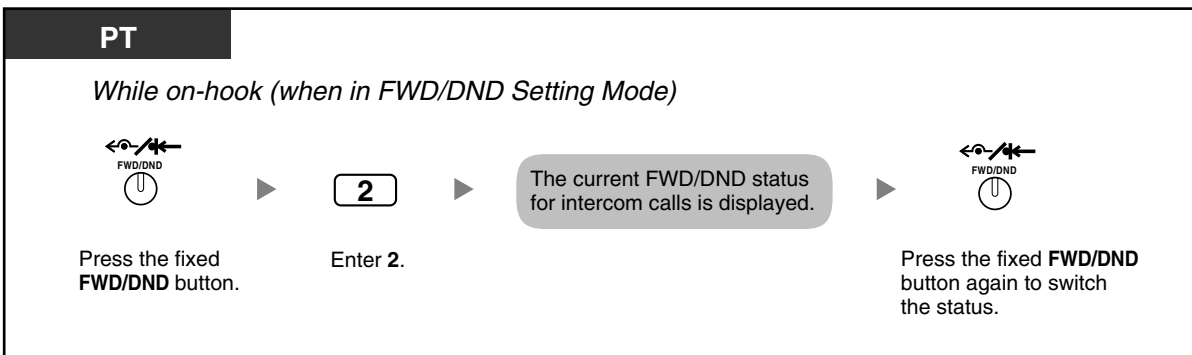

### To set and clear FWD/DND for outside/intercom calls

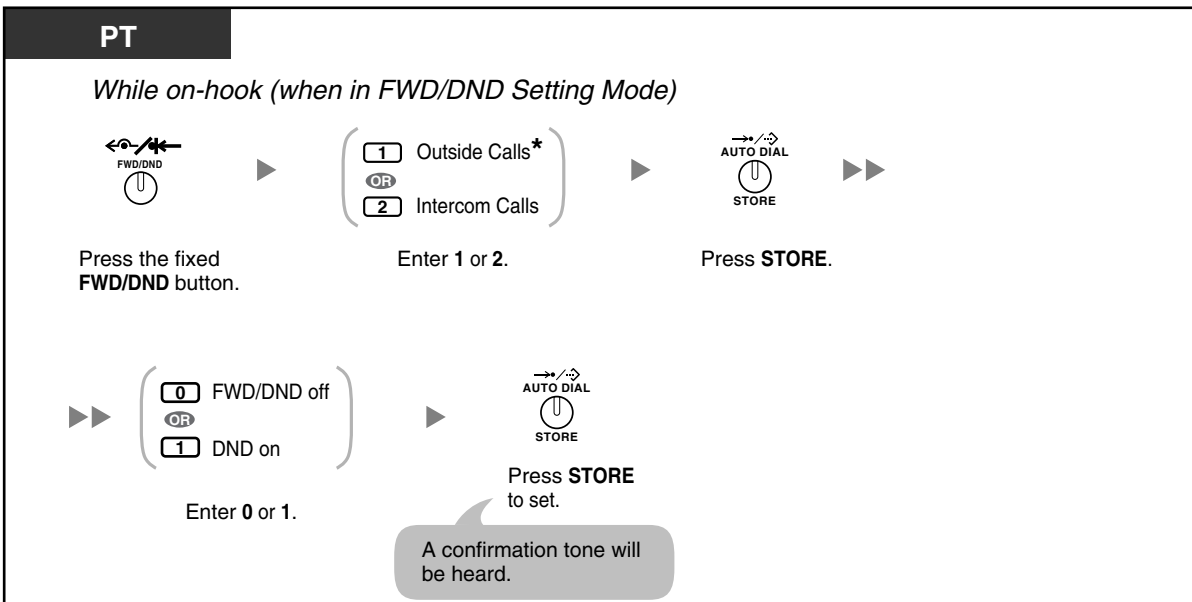

- \* This step can be omitted.

### 1.8.3 Receiving Call Waiting (Call Waiting/Off-hook Call Announcement [OHCA]/Whisper OHCA)

During a conversation, you can be informed of a call waiting with a tone or voice announcement through your built-in speaker or handset. (Default: Disable—No call [Intercom calls]/No tone [Outside calls])

**Call Waiting Tone:**

a waiting tone through the built-in speaker of PT/handset of SLT. To change the tone from PT, refer to "3.1.2 Settings on the Programming Mode".

**OHCA:**

a voice announcement through the built-in speaker

**Whisper OHCA:**

a voice announcement through the handset

**To set/cancel for intercom calls (Manual Call Waiting)**

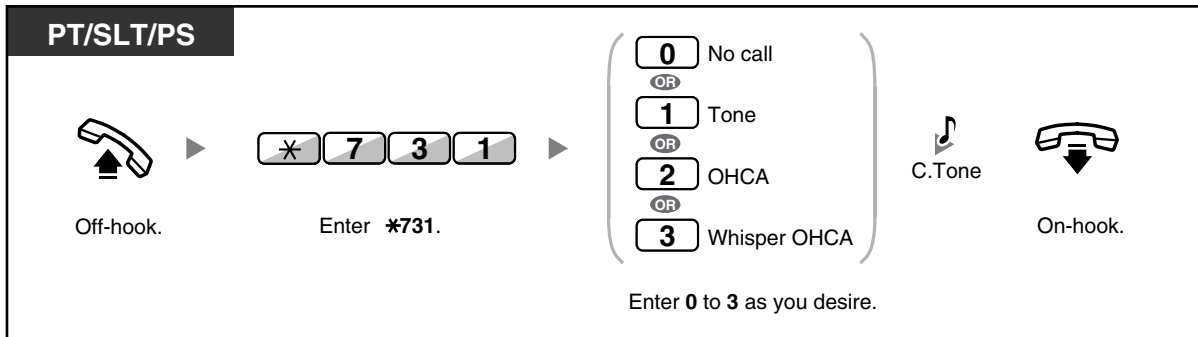

**To set/cancel for outside calls (Automatic Call Waiting)**

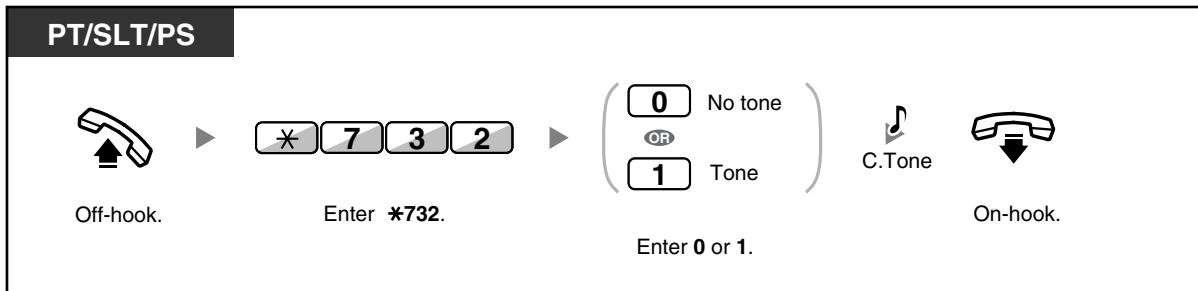

- OHCA is only available with certain digital proprietary telephones.
- Whisper OHCA is only available with certain digital proprietary telephones and IP proprietary telephones. In addition, both you and the other party must use supported telephones.
- A PDN extension can only receive OHCA or Whisper OHCA from the corresponding SDN extension. When a call is made from another extension, a PDN extension will receive a call waiting tone. (→1.5.1 Primary Directory Number (PDN)/Secondary Directory Number (SDN) Extension (KX-TDA100/KX-TDA200/KX-TDA600 only))

### 1.8.4 Displaying Your Telephone Number on the Called Party and Caller's Telephone (Calling/Connected Line Identification Presentation [CLIP/COLP])

**CLIP:**

When making an outside call, you can present your preprogrammed telephone number to the called party.

**COLP:**

When receiving an outside call, you can present your preprogrammed telephone number to the calling party.

You can select the telephone number sent, either the number of the line used or the number assigned to your extension.

If you select "Public", the calling/called party sees the number of the line used (subscriber's number).

If you select "Your extension", they see the telephone number assigned on your extension.

**To show either the number assigned to the outside line or your extension**

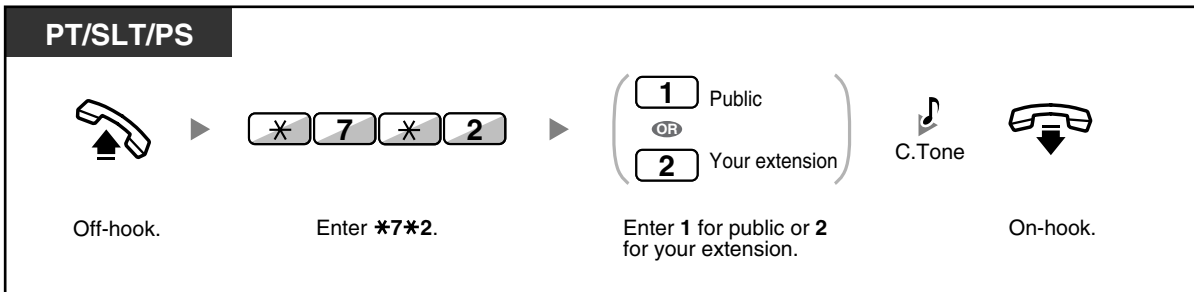

- Availability of this feature depends on the ISDN service of your telephone company.



- If you use the ICD Group button to make a call to the other party, the telephone number assigned to the ICD Group will be used.



## 1.8.5 Preventing Your Telephone Number Being Displayed on the Caller's Telephone (Connected Line Identification Restriction [COLR])

When receiving an outside call, you can select whether the caller can see your telephone number or not.

### To show/prevent

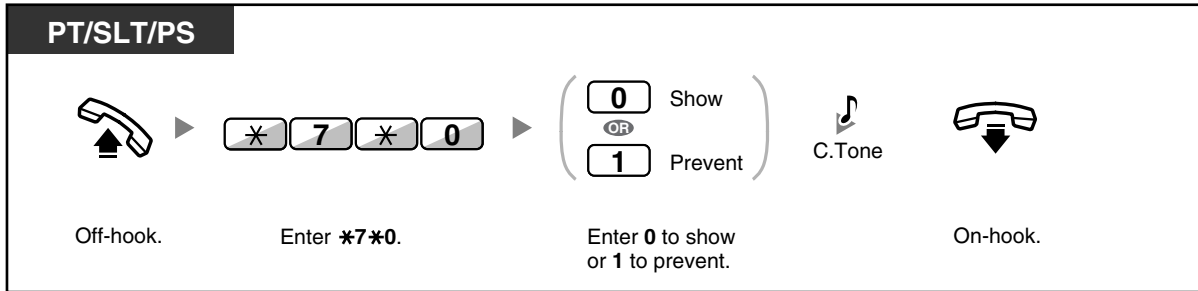

- You can change the mode by pressing a preset COLR button while on-hook. The COLR button light shows the current status as follows:  
**Off:** shows your telephone number.  
**Red on:** prevents your telephone number being displayed.
- Availability of this feature depends on the ISDN service of your telephone company.



### Customising Your Phone

- 3.1.3 Customising the Buttons  
 Create or edit a Connected Line Identification Restriction (COLR) button.

## 1.8.6 Preventing Your Number Being Displayed on the Called Party's Telephone (Calling Line Identification Restriction [CLIR])

When making an outside call, you can select whether the called party can see your telephone number or not.

### To show/prevent

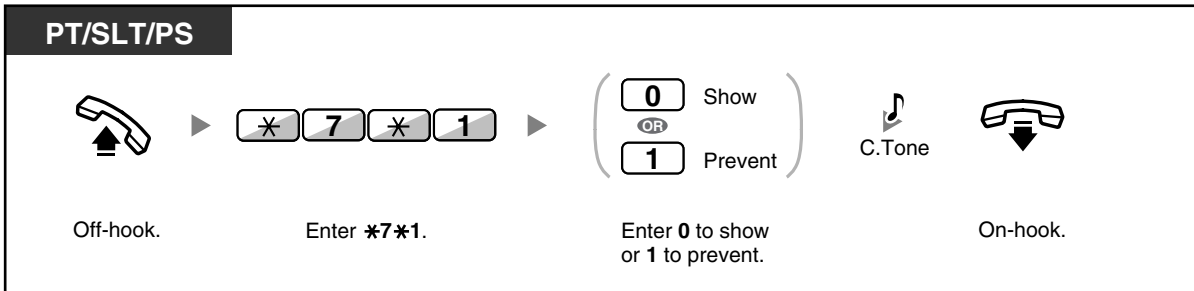

- You can change the mode by pressing a preset CLIR button while on-hook. The CLIR button light shows the current status as follows:  
**Off:** shows your telephone number.  
**Red on:** prevents your telephone number being displayed.
- Availability of this feature depends on the ISDN service of your telephone company.



### Customising Your Phone

- 3.1.3 Customising the Buttons  
Create or edit a Calling Line Identification Restriction (CLIR) button.

## 1.8.7 Preventing Other People from Joining Your Conversation (Executive Busy Override Deny)

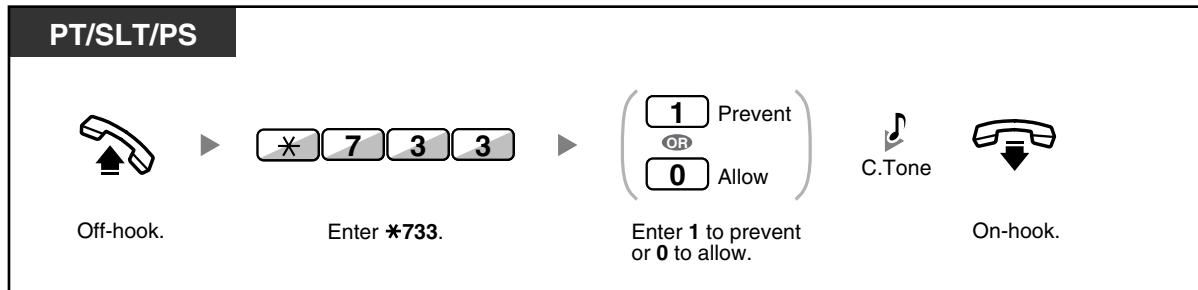

- Some extensions may be prohibited from performing this feature.

## 1.8.8 Turning on the Background Music (BGM)

You can listen to the background music through your telephone speaker while on-hook. An external music source, such as a radio, must be connected.  
 If your extension becomes busy (off-hook, making or receiving a call etc.), the music stops temporarily. When you go back on-hook, the music starts again.



### To select and set/cancel

<For users of KX-TDA100/KX-TDA200/KX-TDA600>

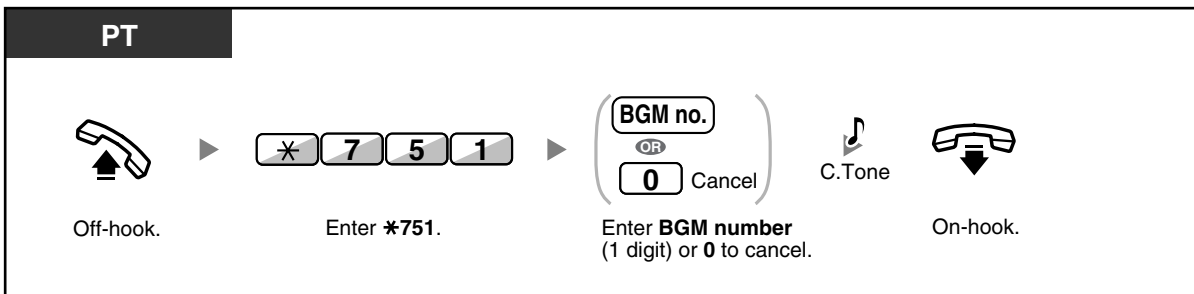

<For users of KX-TDA30>

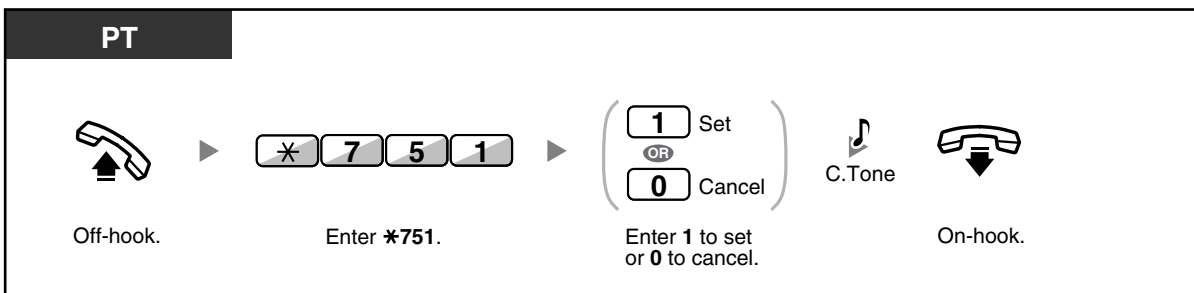

## 1.8.9 Protecting Your Line against Notification Tones (Data Line Security)

You can protect the line against audible notification tones, such as a call waiting tone during a conversation. Set this feature if your extension has a data communication device, such as a computer or fax machine connected to ensure secure data transmission.

### To set/cancel

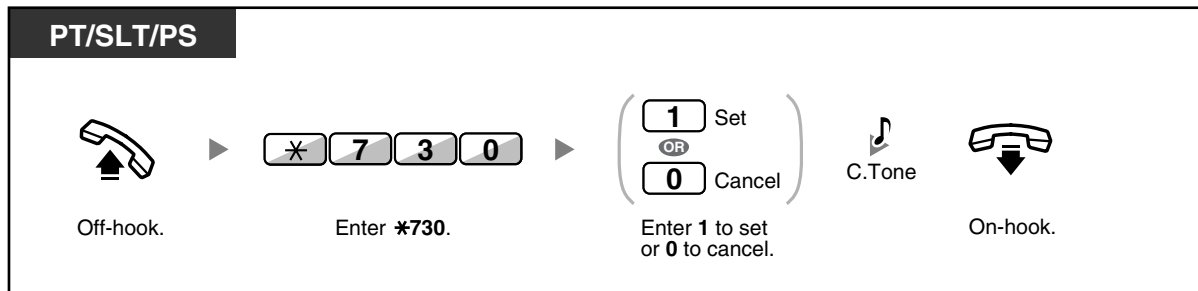

## 1.8.10 Checking the Time Service Status

You can check the current status of the Time Service on the display.

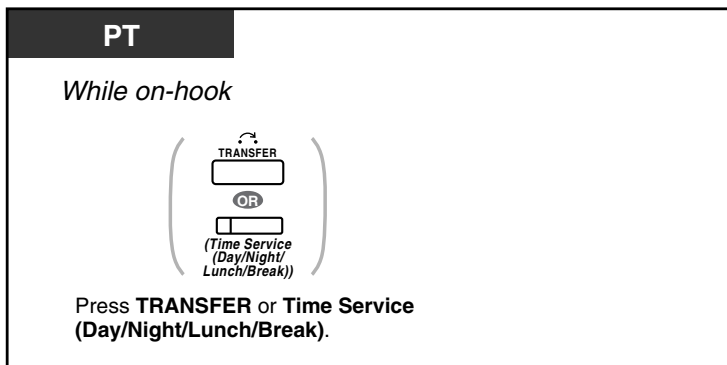

- The Time Service (Day/Night/Lunch/Break) button light shows the current status as follows:
  - Off:** Day mode
  - Green on:** Lunch mode
  - Flashing green:** Break mode
  - Red on:** Night mode
  - Flashing red:** Holiday mode
- Any extension user except the managers can check the current status by pressing the Time Service (Day/Night/Lunch/Break) button.



### Customising Your Phone

- 3.1.3 Customising the Buttons
  - Create or edit a Time Service (Day/Night/Lunch/Break) button.

## 1.8.11 Setting the Paralleled Telephone to Ring (Paralleled Telephone)

In the case where a single line telephone is connected in parallel to your digital proprietary telephone, you can choose whether the paralleled single line telephone will ring to an incoming call or not.  
(Default: Ring)

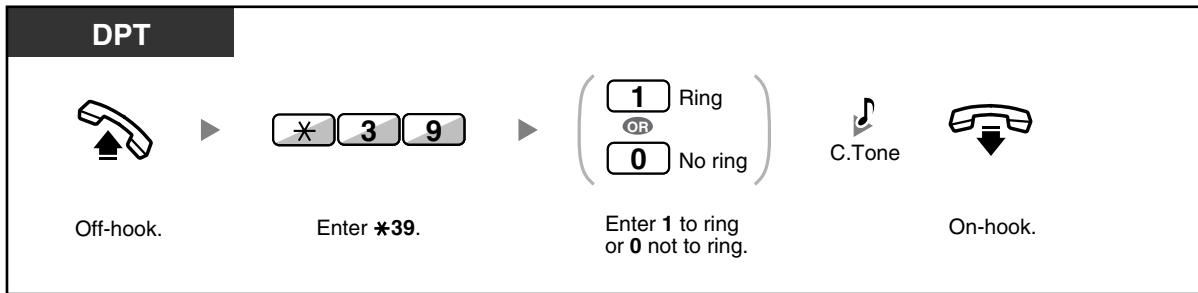

- **Even if "No ring" is selected**, calls can be made and answered on the single line telephone by lifting the handset.
- **If you go off-hook while your paralleled telephone is in use**, the call will switch over to you.
- This feature is not available for the KX-T7665.

## 1.8.12 Using Your PS in Parallel with a Wired Telephone (Wireless XDP Parallel Mode)

Your PS can be used in parallel with a PT or SLT.

When in this mode, incoming calls to a wired telephone also ring the paired PS.

### To set

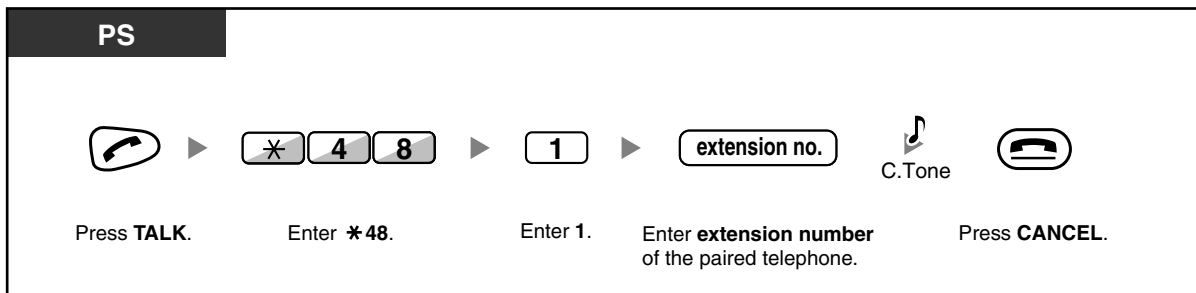

### To cancel

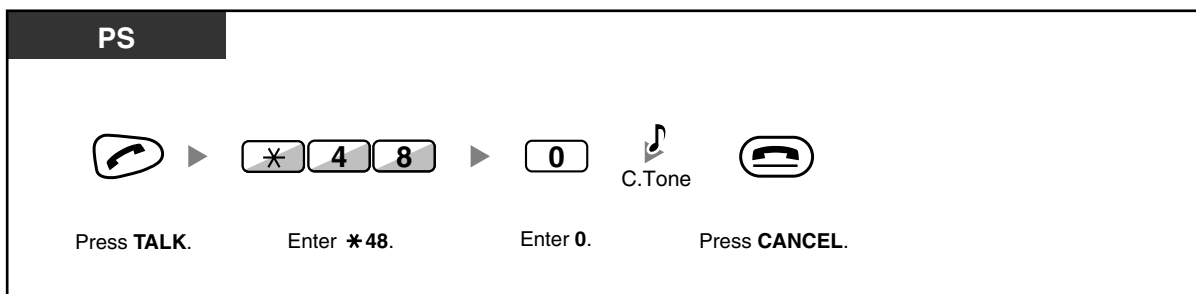

- Some wired telephones are prohibited from using this feature.
- **If you go off-hook while your paralleled telephone is in use, the call will switch over to you.**



### 1.8.13 Clearing Features Set at Your Extension (Extension Feature Clear)

You can reset the settings of the following features on your extension to the default settings with one operation.

This feature is also known as Station Programme Clear.

Features	Default Setting
Hot Line*	Off
Message Waiting—(All the messages that have been left by other extension users)	Off
Call Pickup Deny	Allow
Call Forwarding (FWD)*	Off
Absent Message	Off
Paging Deny	Allow
Timed Reminder	Cleared
Do Not Disturb (DND)*	Off
Call Waiting for intercom calls*	Disable (No call)
Call Waiting for outside calls*	Disable (No tone)
Executive Busy Override Deny	Allow
BGM	Off
Data Line Security	Off
Paralleled Telephone	The telephone in parallel rings.
Log-in/Log-out	Log-in

\* These features may not be reset depending on the system programming.

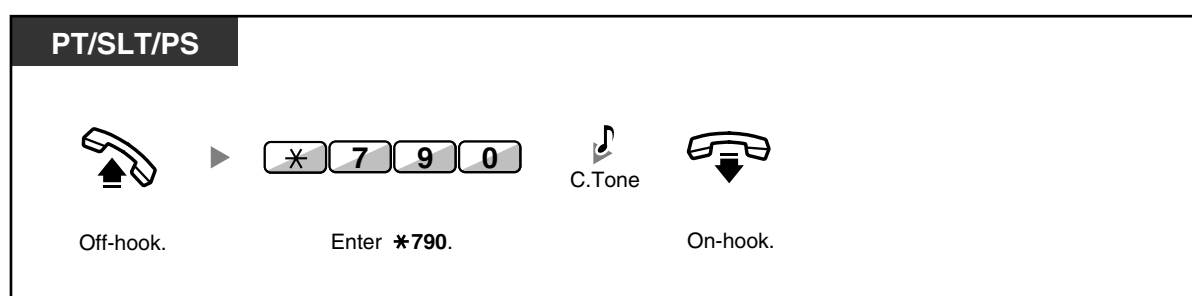

- For Users in Canada Only:  
After performing Extension Feature Clear, the setting of Call Waiting becomes "Enable (Tone)". In this case, dial tone 2 will be heard when you go off-hook.

# 1.9 Utilising the Call Centre

## 1.9.1 Leaving an Incoming Call Distribution Group (Log-in/Log-out, Wrap-up)

You can control your status in an incoming call distribution group. When in the Log-out mode, incoming calls to the group will not ring at your extension. When you return, calls will again ring at your extension. (Default: Log-in)  
 Even if your extension is logged-in, you can have a specified time period (wrap-up time) when you will not receive calls after completing a previous call. This time can be used for you to write a report and so on.  
 You can also manually select "Not Ready" mode to temporarily leave a distribution group.

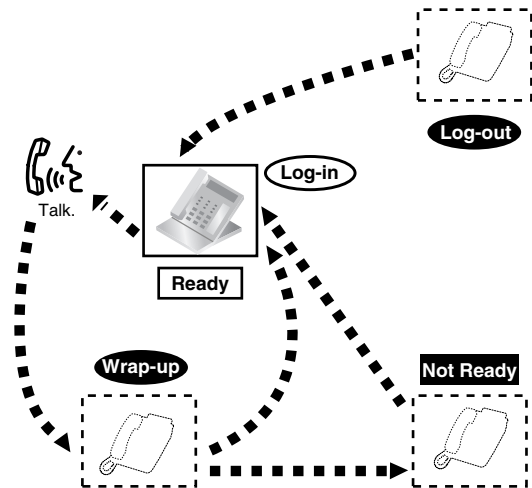

### To set Log-in/Log-out



**PT/SLT/PS**      *ICD Group: Incoming Call Distribution Group*

▶
\*
7
3
6
▶
0 Log-out  
OR  
1 Log-in

Off-hook.                      Enter \*736.                      Enter 0 or 1.

▶▶
ICD Group extension no. Specified  
OR  
\* All

Enter ICD Group extension number or \*.

        
 C.Tone                      On-hook.

**PT/PS** *ICD Group: Incoming Call Distribution Group*

*While on-hook*

Press **Log-in/Log-out**. Enter **ICD Group extension number** or **\***.

**PT/PS**

*While on-hook*

Press **Log-in/Log-out of a specified group**.

**To enter/leave Not Ready mode**

**PT/SLT/PS**

Off-hook. Enter **\*735**. Enter **1** or **0**. C.Tone On-hook.

**To set/cancel Not Ready mode or to leave Wrap-up mode (To enter Ready mode)**

**PT/PS**

*While on-hook*

Press red or flashing red **Wrap-up**.\*

## 1.9 Utilising the Call Centre

---



- \* The status will be as follows:  
Ready → Not Ready  
Not Ready → Ready  
Wrap-up → Not Ready
- The Log-in/Log-out of a specified group button light shows the current status as follows:  
**Off:** Log-in mode  
**Red on:** Log-out mode
- The Wrap-up button alternates the setting of Wrap-up mode, Not Ready mode or Ready mode.  
The Wrap-up button light shows the current status as follows:  
**Off:** Ready mode  
**Red on:** Not Ready mode  
**Flashing red:** Wrap-up mode
- In Wrap-up mode/Not Ready mode, your extension does not receive calls through any group, even if it belongs to multiple groups.
- The last remaining logged-in extension may not be allowed to log out, depending on system programming.
- The Supervisor extension can control the Log-in/Log-out status of other extensions.  
For more information, refer to "1.9.2 Monitoring and Controlling the Call Status of an Incoming Call Distribution Group (Incoming Call Distribution Group Monitor)".



### Customising Your Phone

- 3.1.3 Customising the Buttons  
Create or edit a Log-in/Log-out button, a Log-in/Log-out of a specified group button or a Wrap-up button.

## 1.9.2 Monitoring and Controlling the Call Status of an Incoming Call Distribution Group (Incoming Call Distribution Group Monitor)

- Monitoring the Status of Waiting Calls
- Monitoring and Changing the Log-in/Log-out Status of Extensions

The extension assigned as a Supervisor extension can monitor and control the status of other extensions in an incoming call distribution group. It should have a PT with 6-line display. The display and DSS buttons show as follows:

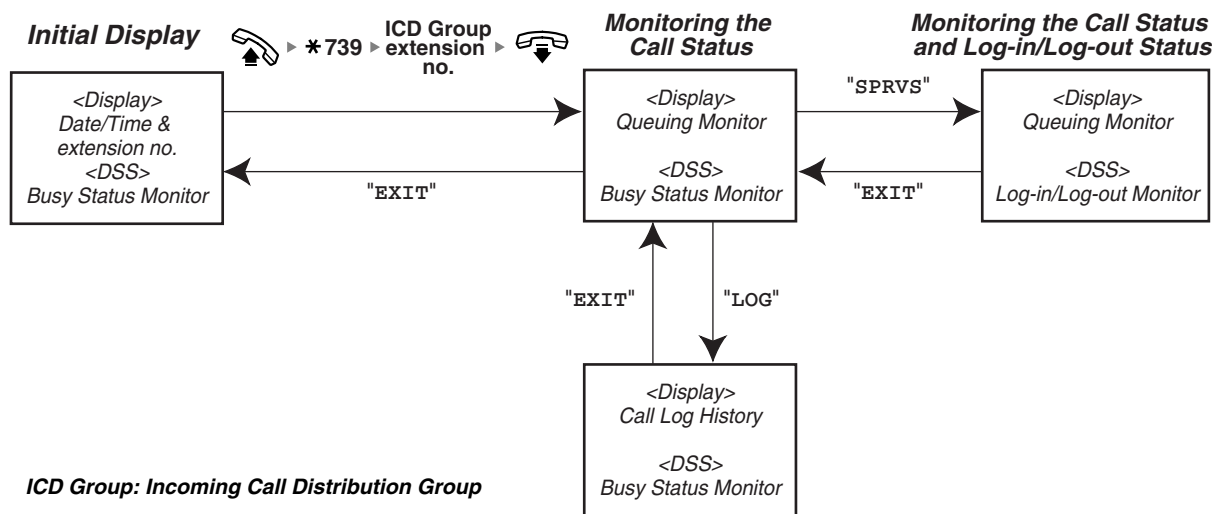

### ◆◆ Monitoring the Status of Waiting Calls

The Supervisor extension can monitor the status of calls waiting to be answered in the queue. If an incoming call distribution group has an overflowed call, the display shows the status automatically. The following information is displayed.

#### <Queuing Monitor>

- The current date/time
- The ICD Group extension number/name
- The number of waiting calls
- The longest waiting time

#### <Call Log History>

- The date/time when cleared at last time
- The total number of received calls
- The number of overflowed calls
- The number of unanswered calls
- The average waiting time of queuing calls

**To monitor**

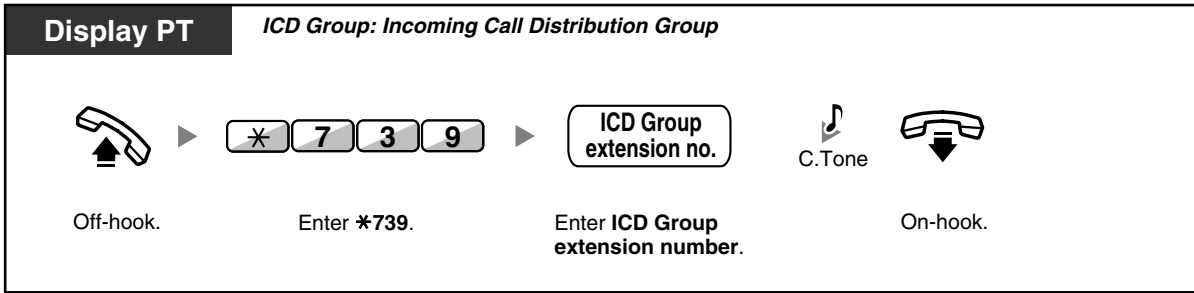

**To clear Call Log History**



- The accumulated data is cleared. "\*\*\*\*\*" shows if the number to be displayed exceeds the maximum displayable digits.

**◆◆ Monitoring and Changing the Log-in/Log-out Status of Extensions**

The Supervisor extension can monitor the Log-in/Log-out status of the incoming call distribution group members by the DSS button light. It can also change their Log-in/Log-out status if needed.

**To monitor**

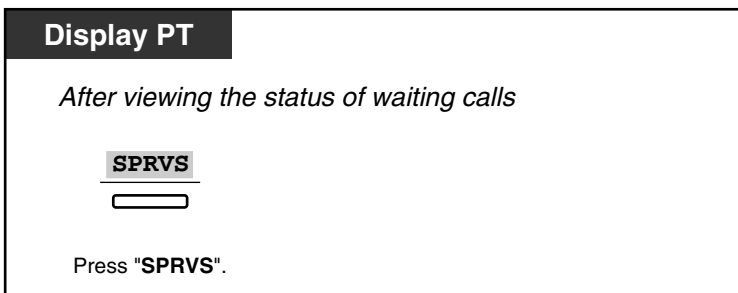

## To change the Log-in /Log-out mode

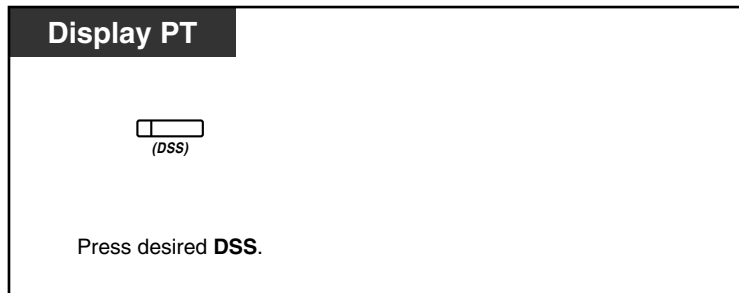

- The DSS button light shows the current status as follows:
  - Off:** The extension is not in the group.
  - Green on:** Log-in (Ready) mode
  - Flashing green:** Log-in (Not Ready) mode
  - Red on:** Log-out mode

## 1.9.3 Forwarding a Waiting Call (Manual Queue Redirection)

When your incoming call distribution group is busy and other outside calls arrive, the arriving calls are put in a waiting queue.

Extensions can check the status of the queue with the Hurry-up button light, and forward the longest waiting call in the queue to a preset destination manually.

This feature is also known as Hurry-up Transfer.



### To forward the waiting call

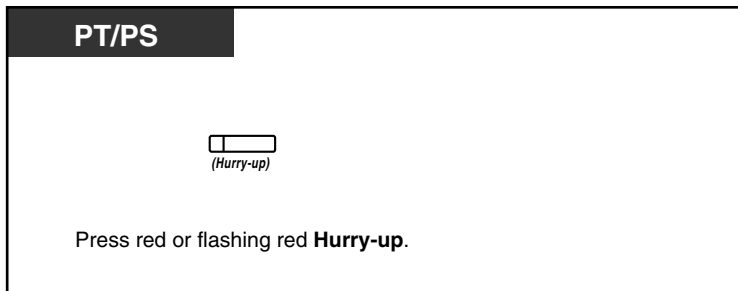

- The Hurry-up button light shows the current status as follows:  
**Off:** No waiting call.  
**Red on:** Some calls are waiting.  
**Flashing red:** The number of calls exceeds the manual queue redirection level.



### Customising Your Phone

- [3.1.3 Customising the Buttons](#)  
Create or edit a Hurry-up button.



## 1.10 Using User-supplied Equipment

### 1.10.1 If a Doorphone/Door Opener is Connected

You can talk to a person at the door through the doorphone. Preprogrammed extensions or an outside party can receive the calls from the doorphone. You can open the door.

- Doorphone Call
- Opening a Door (Door Open)

#### ◆◆ Doorphone Call

##### To call from the doorphone

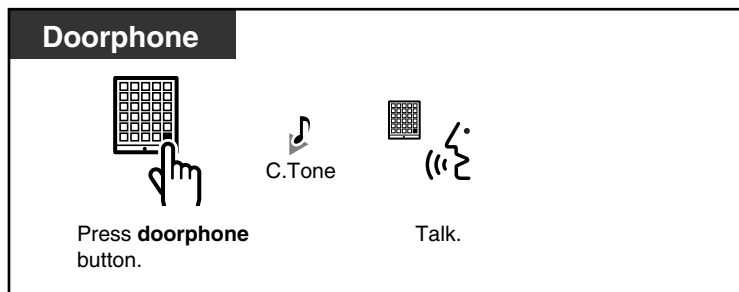

##### To answer a call from the doorphone



##### To call the doorphone

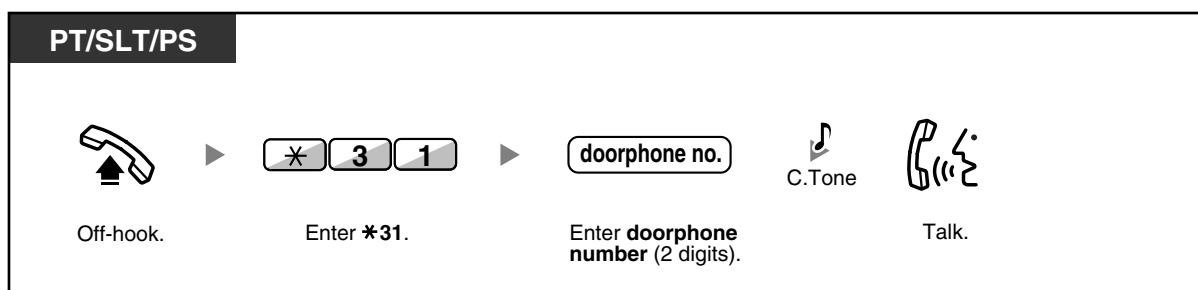

- If no one answers a doorphone call within a specified time period, the call is cancelled.

## ◆◆ Opening a Door (Door Open)

Some extensions may be prohibited from using this feature.

### From a specified extension

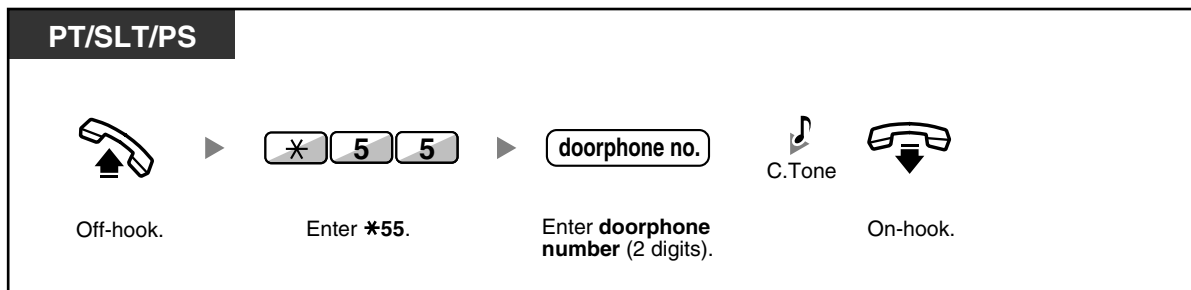

### From any extension while talking to the doorphone

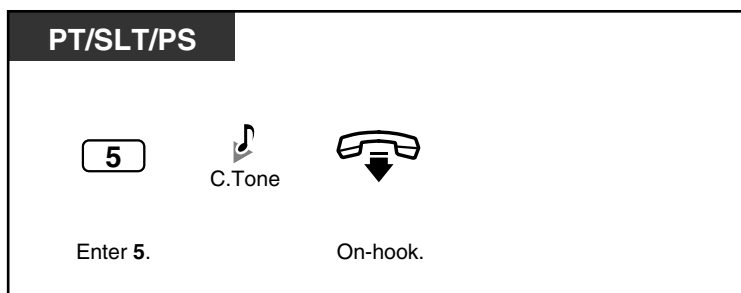

- The door open will be triggered for a specified time period.

## 1.10.2 If an External Relay is Connected

Preprogrammed extensions can switch on a relay (e.g., alarm) connected to the PBX.

### To switch on the relay

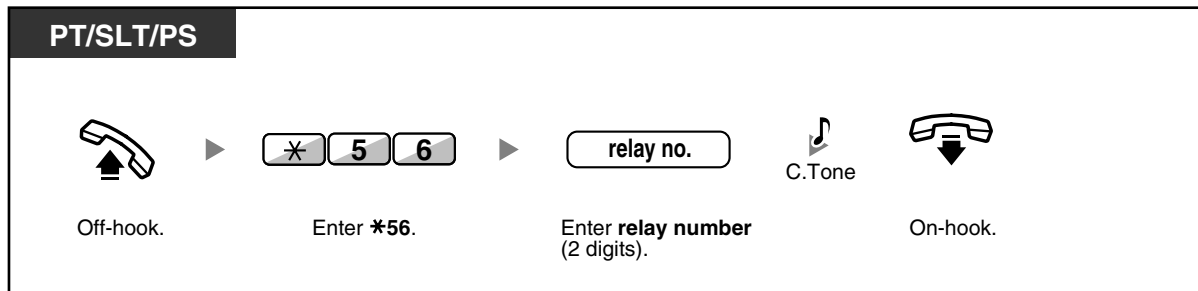

- The relay will be switched off after a specified time period.

### 1.10.3 If an External Sensor is Connected

Preprogrammed extensions can receive an alert call from an external sensor (e.g., security alarm) connected to the PBX.

#### To answer a sensor call

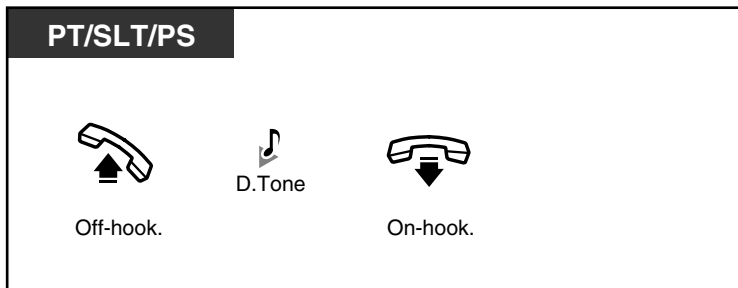

- If you do not answer a sensor call within a specified time period, the sensor call will stop.

### 1.10.4 If a Host PBX is Connected

- Accessing External Services (External Feature Access [EFA])

#### ◆◆ Accessing External Services (External Feature Access [EFA])

You can access special features (e.g., Call Waiting) offered by a host PBX or telephone company. This feature is only effective for an outside call.

<Example> To hold the current call and then talk to the new party

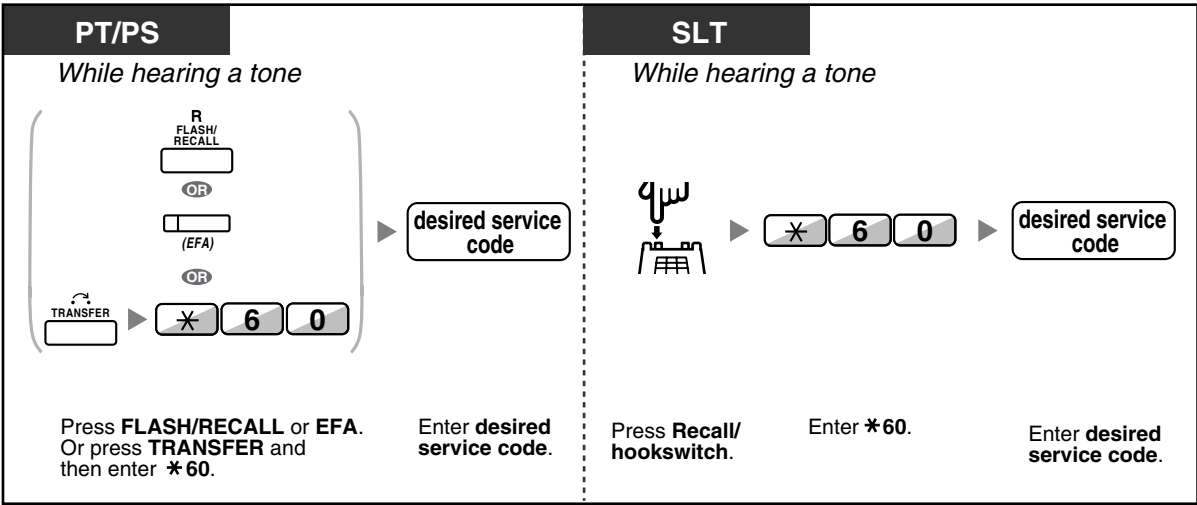

- In this case, the FLASH/RECALL button on a proprietary telephone must be set to External Feature Access (EFA) mode through system programming.

#### 👉 Customising Your Phone

- 3.1.3 Customising the Buttons  
Create or edit an External Feature Access (EFA) button.

### 1.10.5 If a Voice Processing System is Connected

You or an outside party can access the Voice Processing System from a telephone.

- Call Forwarding to Voice Mail (Voice Mail Integration)

If your PBX has a Panasonic Voice Processing System connected (e.g., KX-TVP/KX-TVS series) using digital integration, the following features are also available:

- Screening Calls (Live Call Screening [LCS])
- Recording a Conversation

#### ◆◆ Call Forwarding to Voice Mail (Voice Mail Integration)

- To forward your calls to your mailbox
- To transfer a call to a mailbox
- To listen to messages

If you cannot answer calls, you can forward them to your mailbox. You can select the type of incoming calls (Intercom Calls/Outside Calls/Both Calls) that are forwarded.

If your telephone has a Message button, the Message light turns on when a message is left in your mailbox. You will hear an indication tone\* when going off-hook, regardless of whether or not your telephone has a Message button.

You can also create a Voice Mail Transfer button on your phone to transfer received outside calls to a mailbox of another extension so that calling parties can leave messages (Voice Mail Transfer).

The duration for recording depends on the voice processing system.

#### To forward your calls to your mailbox

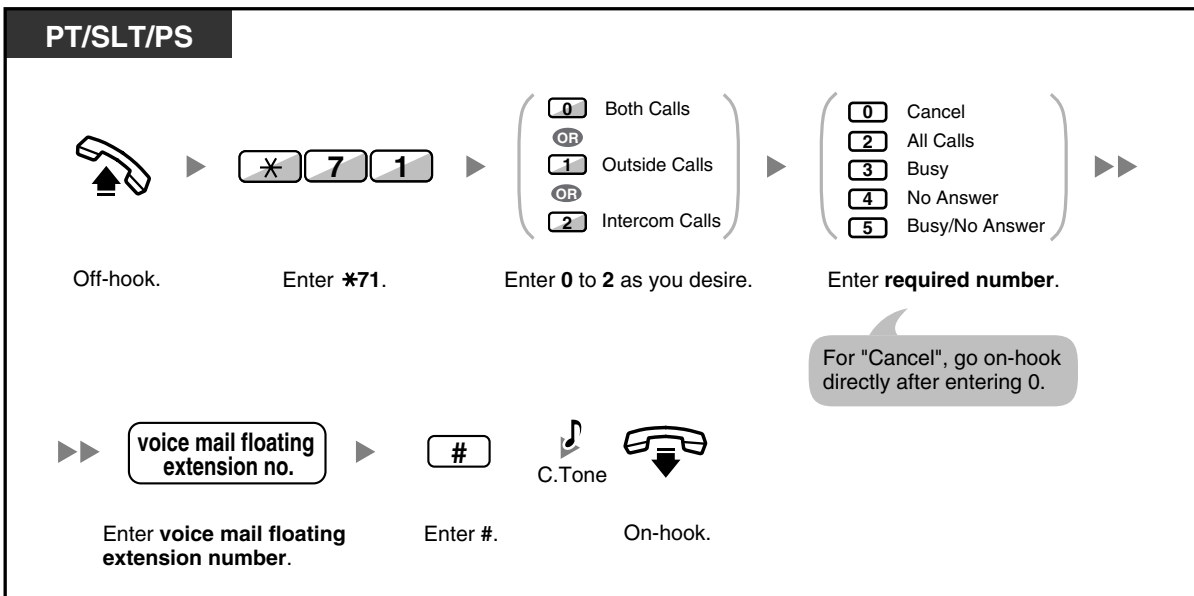

**To transfer a call to a mailbox**

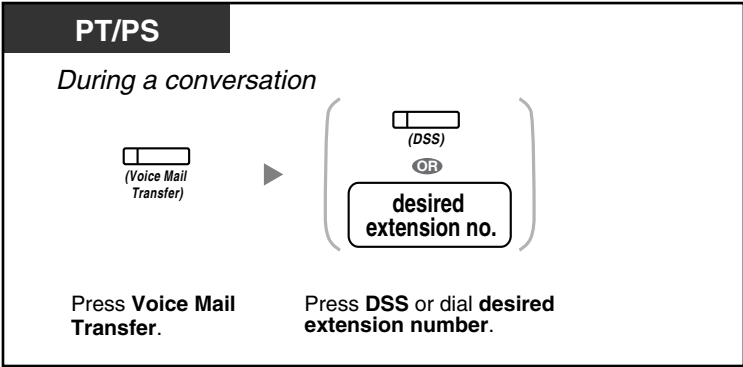

**To listen to messages**

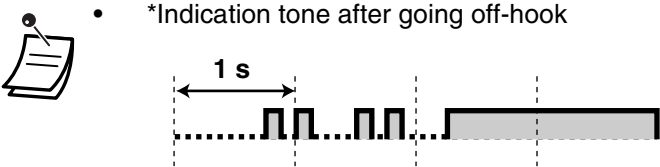
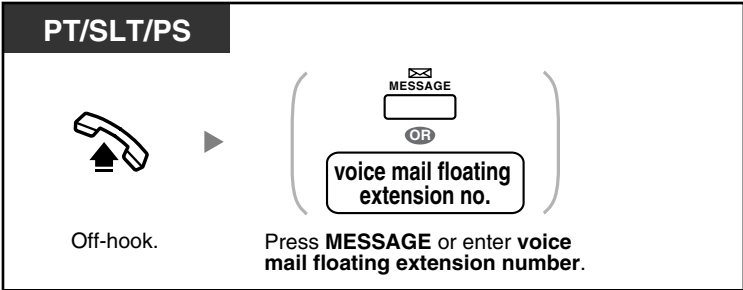

- You can access a voice mail with one touch.



- The default voice mail floating extension number is 500.



**Customising Your Phone**

- 3.1.3 Customising the Buttons  
Create or edit a Voice Mail Transfer button or a Message button.

## ◆◆ Screening Calls (Live Call Screening [LCS])

While a caller is leaving a message in your mailbox, you can monitor the call without answering. If you so desire, you can answer the call while monitoring. There are two methods available (Default: Hands-free mode).



**Hands-free mode:**

You can monitor the message automatically, live through the telephone speaker.

**Private mode:**



You will hear an alarm tone while the caller is leaving a message.

### Before operating

- Create a Live Call Screening (LCS) button (Personal Programming).
- Select the mode, either Hands-free or Private (Personal Programming).
- Set the extension PIN (Personal Identification Number).
- Set the Live Call Screening feature.

### To set Live Call Screening

**PT/PS** *PIN: Personal Identification Number*

  **extension PIN**

Press **Live Call Screening**.

Enter **extension PIN** (max. 10 digits).

This is required only when an extension PIN is stored.

### To cancel Live Call Screening

**PT/PS**



Press red **Live Call Screening**.



## Operation Flowchart

The operations in the shaded areas can be done hands-free.

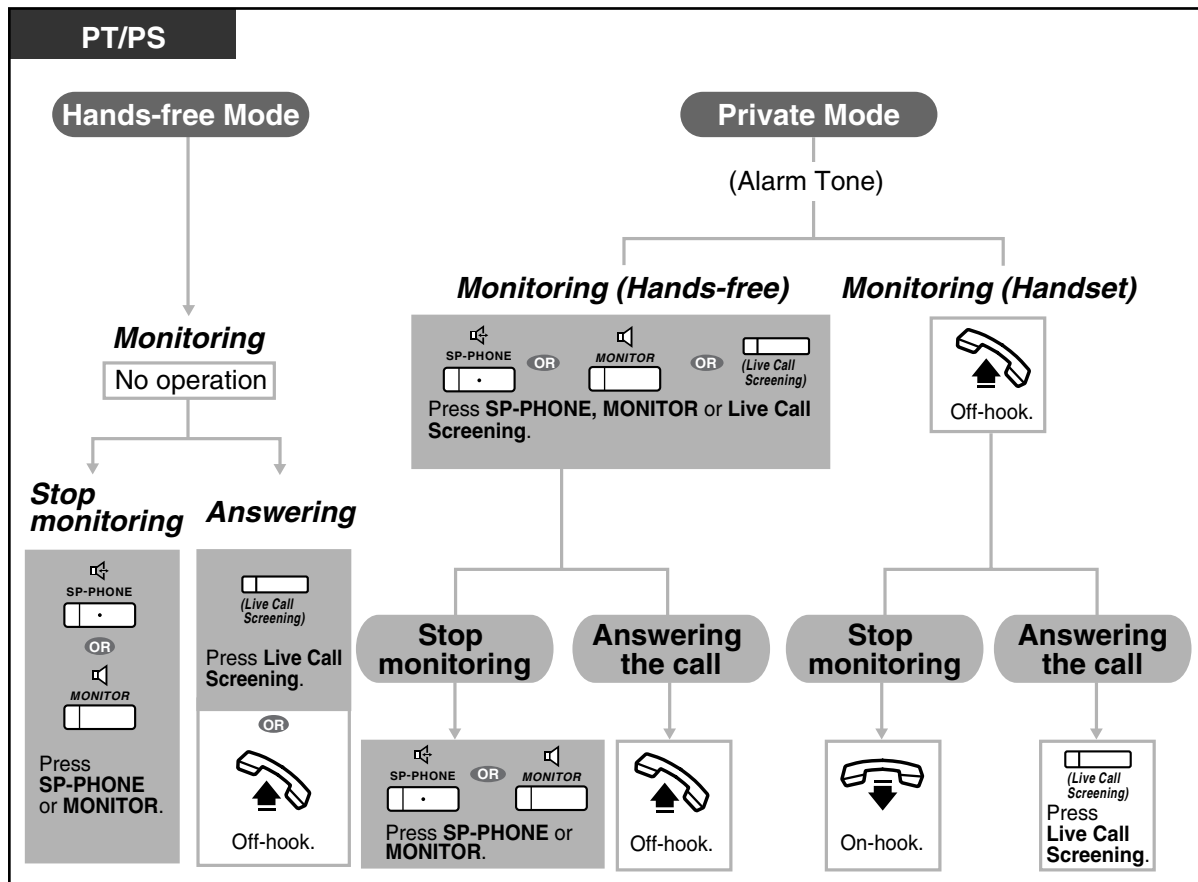

- The Live Call Screening (LCS) button light shows the feature status as follows:
  - Off:** LCS is off.
  - Flashing green rapidly:** Alerting in the Private mode.
  - Flashing green slowly:** Monitoring.
  - Red on:** LCS is on.
- The manager extension can clear an extension PIN.
- This feature is available for a single line telephone if it is connected to a proprietary telephone in parallel. (Private mode only)
  - To answer the call while monitoring, press Recall/hookswitch.
- Only the handset monitoring in the Private mode is available for PS users.



### Customising Your Phone

- 3.1.2 Settings on the Programming Mode—**Live Call Screening Mode Set**  
Select the mode, either monitoring the message through the speaker automatically or receiving, while the caller leaves a message.
- 3.1.3 Customising the Buttons  
Create or edit a Live Call Screening (LCS) button.

## ◆◆ Recording a Conversation

You can record a conversation into a mailbox while talking on the phone. You can select the mailbox each time you record a conversation.



### To record into your mailbox (Two-way Record)

**PT/PS**

*During a conversation*

 (Two-way Record)

To stop recording, press this button again.

Press **Two-way Record**.



### To record into another mailbox (Two-way Transfer)

**PT/PS**

*During a conversation*

 (Two-way Transfer)

Press **Two-way Transfer**.

 (DSS)  
OR  
 another extension no.

Press **DSS** or enter another extension number.

To stop recording, press this button again.

### To record into another mailbox with one touch (One-touch Two-way Transfer)

**PT/PS**

*During a conversation*

 (One-touch Two-way Transfer)

Press **One-touch Two-way Transfer**.



- The Two-way Record button light, Two-way Transfer button light or One-touch Two-way Transfer button light shows the current status as follows:  
**Off:** Not recording.  
**On:** Recording the conversation.



- **Note:**  
When you record your Two-way telephone conversations, you should inform the other party that the conversation is being recorded.



### Customising Your Phone

- 3.1.3 Customising the Buttons  
Create or edit a Two-way Record button, a Two-way Transfer button and a One-touch Two-way Transfer button.

# 1.11 Administrative Features

## 1.11.1 Using the Telephones in a Hotel-type Environment (Hospitality Features)

In a hotel-type environment, an extension assigned as a hotel operator can be used to view and set the check-in/check-out status of each guest room extension. When the hotel operator presses a flexible button assigned as "Check-in" or "Check-out" on his extension, the extension will switch to Room Status Control mode, and the light of the DSS button for each room extension will show the current room status. This allows the hotel operator to manage guests and rooms with just a telephone. In addition, the hotel operator can set automatic wake-up calls for guest rooms.



- Check-in
- Check-out
- Setting a Timed Reminder to a Room Extension (Remote Wake-up Call)



- The hotel operator must be using a 6-line display PT to use the Check-in and Check-out features.
- While in Room Status Control mode:
  - a. The hotel operator's extension can only check extensions in or out. All other operations will be ignored.
  - b. The light of each DSS button shows the room status of the corresponding extension as follows:  
**Off:** Check-out  
**Red on:** Check-in
  - c. The lights of other buttons may not show their normal display.
  - d. The hotel operator's extension is considered to be busy. Callers to that extension will hear a busy tone.

### ◆◆ Check-in

The hotel operator can change the room status of extensions to check-in by using the Check-in button assigned on his extension.

#### To check in

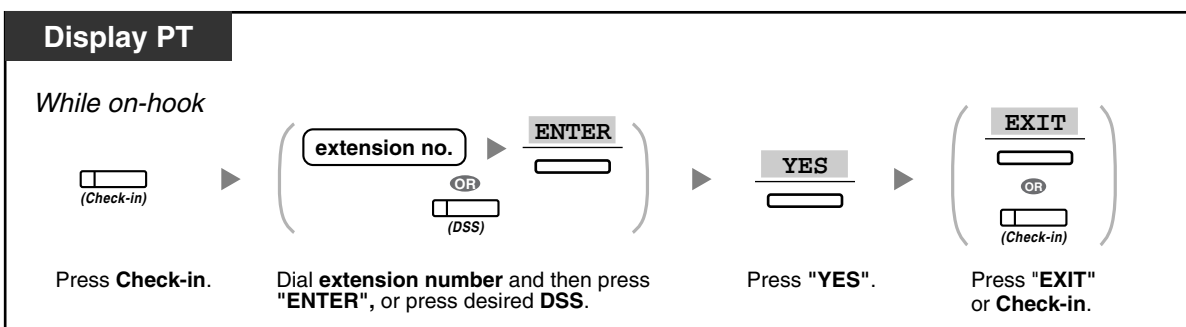



- After check-in, Remote Extension Dial Lock is deactivated, and the guest can make outside calls from the room extension. (Refer to "2.1.1 Extension Control".)
- After check-in, all billing data previously charged to the extension will be cleared automatically.
- When the room status of extensions is changed, detailed room status information is recorded automatically. This requires system programming.  
<Example>

Date	Time	Ext	CO	Dial Number
02/02/00	03:07PM	1234		Check in

## ◆◆ Check-out

The hotel operator can change the room status of extensions to check-out by using the Check-out button assigned on his extension.

Depending on the setting of the PBX, the hotel operator can do the following:

- Record/edit charges for Minibar/Others
- Print out an invoice containing charge information

### To check out a room with/without printing an invoice

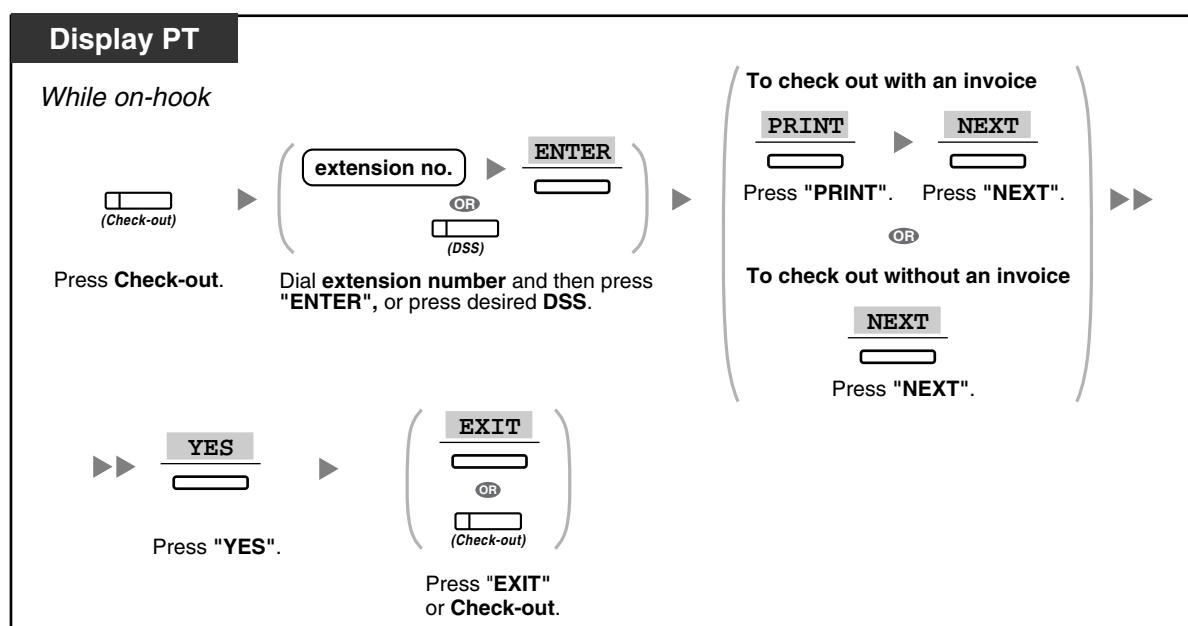

To record/edit room charges and check out a room with/without printing an invoice

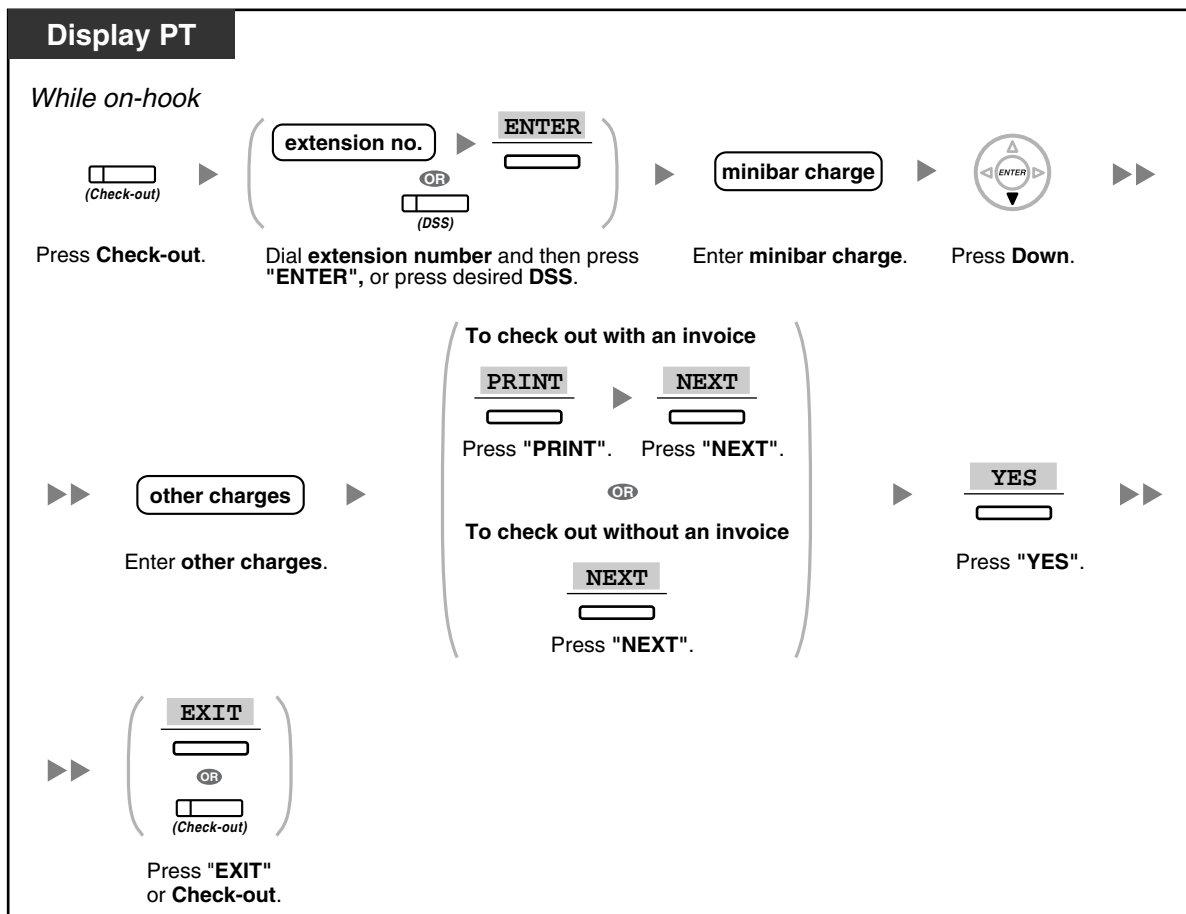



- After check-out, Remote Extension Dial Lock is activated, and outside calls from the room extension are restricted. (Refer to "2.1.1 Extension Control".)
- After check-out, wake-up call and Call Log information for the room extension are cleared automatically. In addition, features set on the room extension are reset to the default settings. For a list of features that are reset, refer to "1.8.13 Clearing Features Set at Your Extension (Extension Feature Clear)".
- When the room status of extensions is changed, detailed room status information is recorded automatically. This requires system programming.  
<Example>

Date	Time	Ext	CO	Dial Number
02/03/00	08:08AM	1234		Check out

- To print out an invoice, a printer should be connected to the PBX. If the room extension is in use, an invoice cannot be printed out.  
<Example>

```

*****
*                Hotel                *
*****
Check in   : 01.JAN.00 06:31PM
Check out  : 03.JAN.00 07:03AM
Room       : 202 : Mr. Smith

01/01/00 06:52PM 202 01 Call amount:0012 01:24'30 00084.50 001
02/01/00 06:07PM 202 01 123456789          00:10'12 00010.20 1234567890
02/01/00 07:30PM 202 01 012345678901234    00:06'36 00006.60 12345
02/01/00 08:45PM 202 01 0011234567890123   00:03'00 00003.00 12345

Telephone                104.30 (Tax 10.000% = 9.48)
Minibar                   4.00 (Tax 10.000% = 0.36)
Others                     0.00 (Tax 15.000% = 0.00)
-----
Total                      FR 108.30 (Tax Total = 9.84)

Sheet : 002

===== Hotel TDAPBX =====
Tel: +41 3 12 34 56 78 Fax: +41 3 12 34 56 78
E-Mail: 12345678@hoteltdapbx.ch

```

- The PBX can store a limited amount of room information. When this storage becomes almost full, the information of the extension that made the most calls is printed out automatically. In this case, the printout is similar to the example above, but without categorised charge information and the total. The PBX can then store new room information. "Call amount:0012" in the example above indicates that the information of 12 phone calls has previously been printed out automatically.



### Customising Your Phone

- 3.1.3 Customising the Buttons  
Create or edit a Check-in or a Check-out button.

## ◆◆ Setting a Timed Reminder to a Room Extension (Remote Wake-up Call)

The hotel operator can remotely set or cancel a Timed Reminder to a room extension. This allows guests to request wake-up calls without having to program the extension themselves. The hotel operator can also confirm the current Timed Reminder setting for a room extension.

### To set

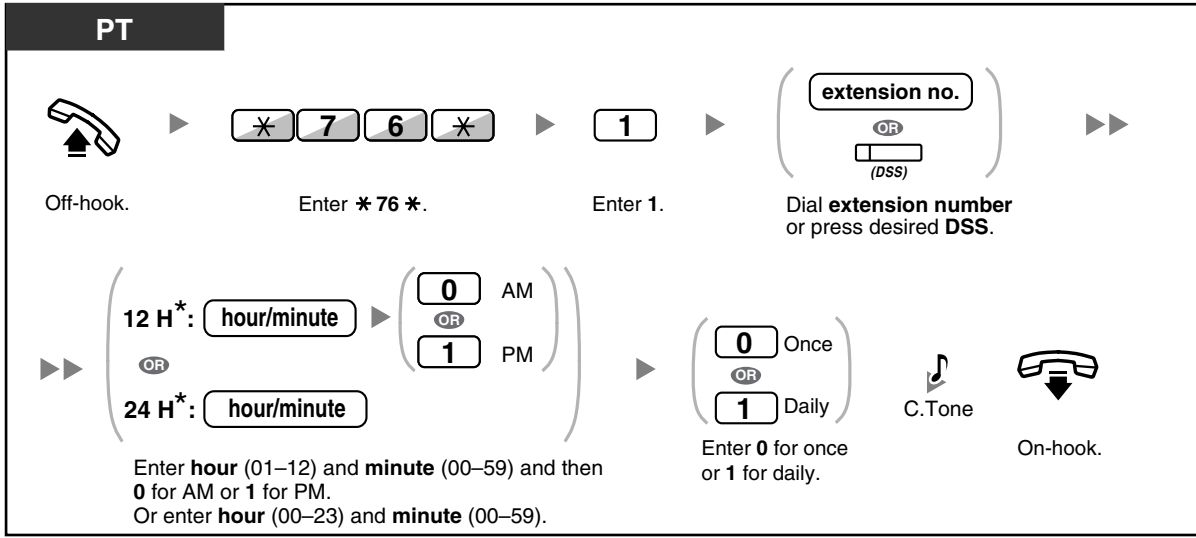

- \* Enter the time in the format assigned to your PBX (12-hour or 24-hour).

### To cancel

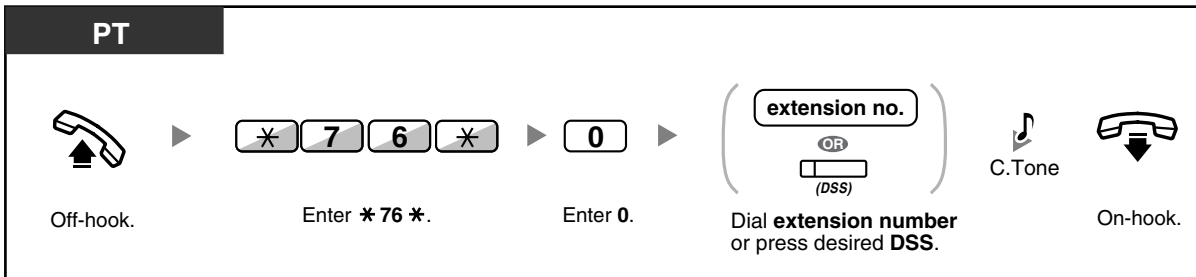



To confirm

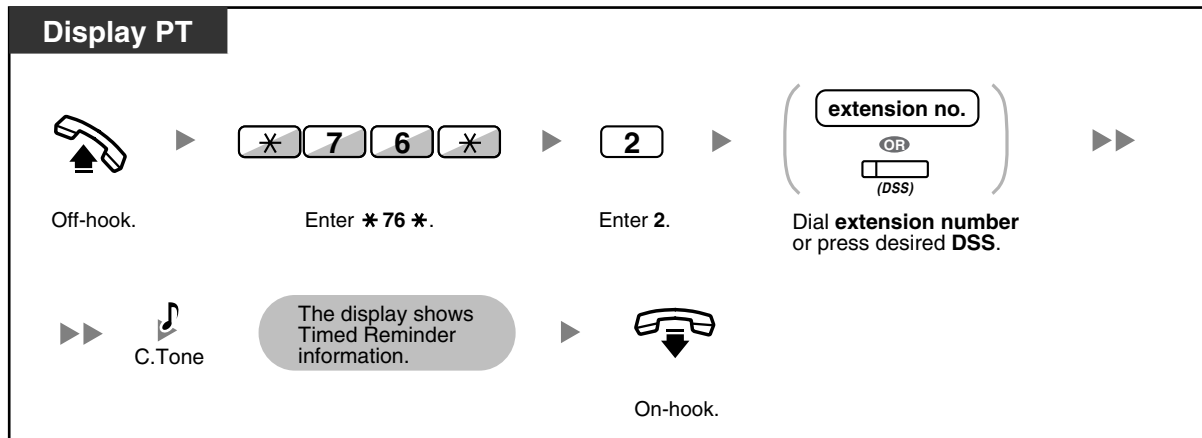

- Timed Reminder can also be set from the room extension. (For information about setting Timed Reminder, refer to "1.8.1 Setting the Alarm (Timed Reminder)".) The most recent setting will be valid no matter which extension made the setting.
- When a Timed Reminder starts, and when it is answered or not answered, detailed Timed Reminder information is recorded automatically. This requires system programming.  
<Example>

Date	Time	Ext	CO	Dial Number
02/02/00	02:45PM	1234		Timed Reminder/Start
02/02/00	02:46PM	1234		Timed Reminder/No Answer
02/02/00	02:47PM	1234		Timed Reminder/Answer



- Users of PTs without displays can confirm only whether a Timed Reminder has been set or not by following the steps shown above. If set, a confirmation tone will be heard.

## 1.11.2 Recording Information Using Preprogrammed Messages (Printing Message)

You can record a variety of information from your extension using up to 8 preprogrammed messages. Message information from all extensions is recorded with the PBX. For example, it is possible to use this feature as a time card by selecting preprogrammed "sign in" and "sign out" messages. In a hotel-type environment, this feature can be used to record room information from a room extension. For a list of preprogrammed messages, consult your dealer.

### To record

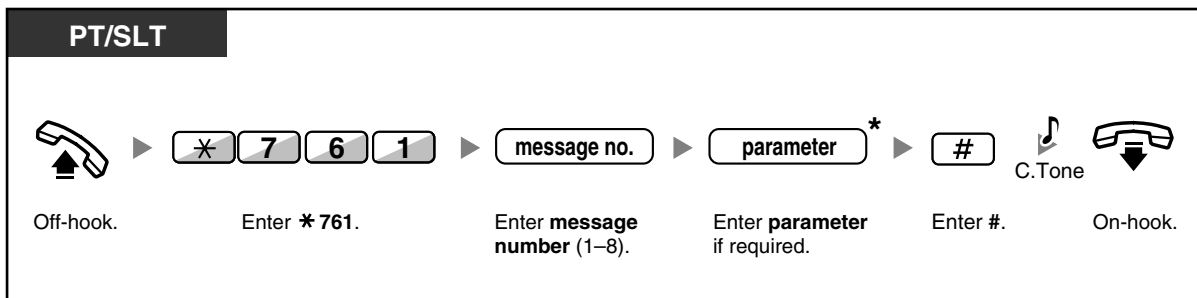

- \* Depending on the content of the selected message, you may be required to enter a numeric parameter, such as a price or time. Enter the correct number of characters as required for the message. For information about required parameters, consult your dealer.

<Example>

If "Snack %%.%" has been programmed as message number 1 (for recording charges for room snacks consumed), hotel employees would enter data as in the example below using the room extension:

\* 761                    1                    0300                    #  
                                   |                    |  
                                   message no.    parameter  
   (Snack charge)

- When a preprogrammed message is selected, detailed information is recorded automatically, as shown below:

Date	Time	Ext	CO	Dial Number
02/02/00	10:45AM	1234		Snack 03.00

- Any charges recorded here are not related to charges that the hotel operator records when checking out a room.

## 1.12 After Moving to a New Location in the Office

### 1.12.1 Using the Same Settings as Your Previous Extension (Walking Extension)

You can use the same features assigned on your previous extension even if you move to another extension in the office.

You can retain your settings, such as extension number or One-touch Dialling memory, on the new extension.

This feature is also known as Walking Station.

#### To set

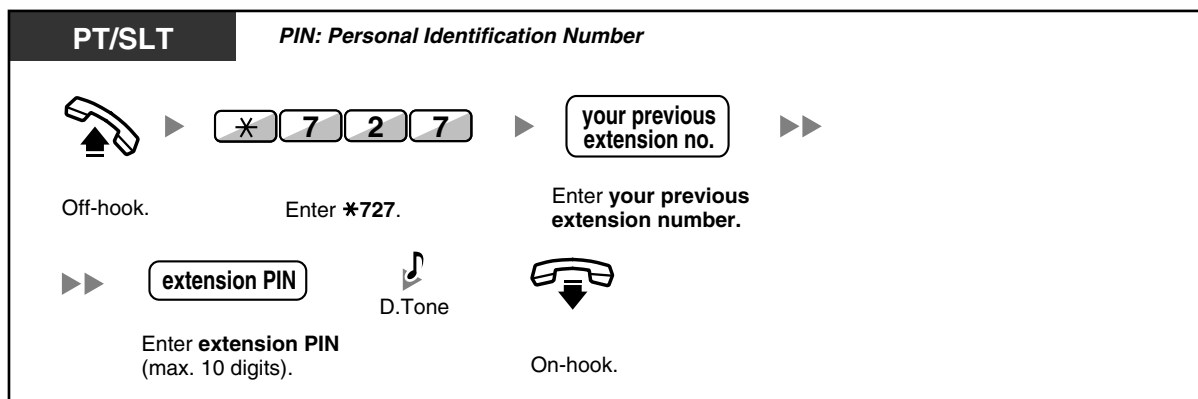

- Your previous extension will receive the old settings of your new extension.
- This feature is available for movement between SLT and SLT, PT and PT or SLT and PT.
- For more information, refer to "3.1.1 Customising Your Phone (Personal Programming)".

# 1.13 Using a Display Proprietary Telephone

## 1.13.1 Using the Call Log

This is available for display proprietary telephones and portable stations.

- Calling with the Incoming Call Log
- Calling with the Outgoing Call Log

### ◆◆ Calling with the Incoming Call Log

When you receive an outside call or an external sensor call, call information is recorded automatically in the incoming call log. A preprogrammed number of calls can be logged per extension.

When the call log is full and other call arrives, the oldest call is deleted.

You can modify the logged telephone number.

When the Call Log button light turns on, there is a call which you did not answer.

The following information is logged.

- Caller's Name
- Date/Time call received
- Answered or Not Answered  
Confirmed or Not Confirmed
- Caller's Phone Number

#### To confirm the log information with the Call Log button

**Display PT**

*While on-hook*

  
(Call Log)

Press **Call Log** until **desired party** appears.

#### To confirm the log information with the Navigator Key

**T7600**

*While on-hook*

  
Press **Left** twice.

▶

  
Press **Up** or **Down** until **desired party** appears.

**To clear the log information**

**Display PT**

*While confirming the log information*

Press **Call Log**, or **Up** or **Down** until **desired party** appears.      Press **TRANSFER**.

**To call**

**Display PT**

*While confirming the log information*

Press **Call Log**, or **Up** or **Down** until **desired party** appears.      Off-hook.

**To store the caller's information in personal speed dialling**

**Display PT**

*While confirming the log information*

Press **Call Log**, or **Up** or **Down** until **desired party** appears.      Press **STORE**.

## 1.13 Using a Display Proprietary Telephone



- The Call Log button light shows the current status as follows:  
**Off:** No incoming call. Or you have already viewed the call log.  
**Red on:** You have missed calls to view.
- If your call is answered by another extension, the caller's information is recorded on the displays of both your extension and the answering extension.
- You can lock your call log display by using an extension PIN (Personal Identification Number), so that you can prohibit access to your logged information (Display Lock). Refer to "3.1.2 Settings on the Programming Mode".
- You can also have a Call Log button for an ICD Group (Incoming Call Distribution Group).
- If a call arrives while you are using the call log, the call log display will be replaced with the caller's information.



### Customising Your Phone

#### 3.1.3 Customising the Buttons

Create or edit a Call Log button or Call Log for ICD Group button.

## ◆◆ Calling with the Outgoing Call Log

You can redial using the outgoing call log.

### To call

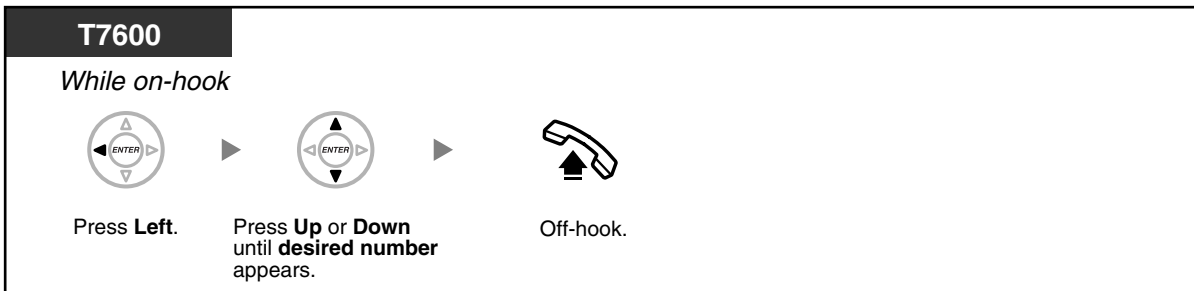

### To call with the REDIAL button

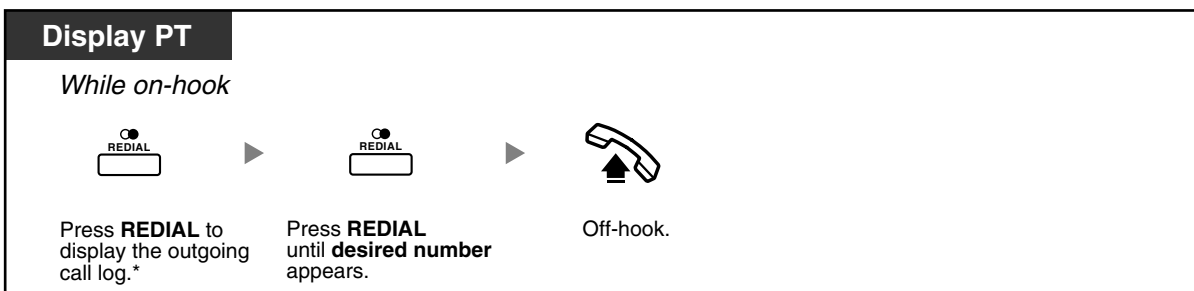

- \* System programming is required for this operation.
- This operation is available only for digital proprietary telephones with a display.

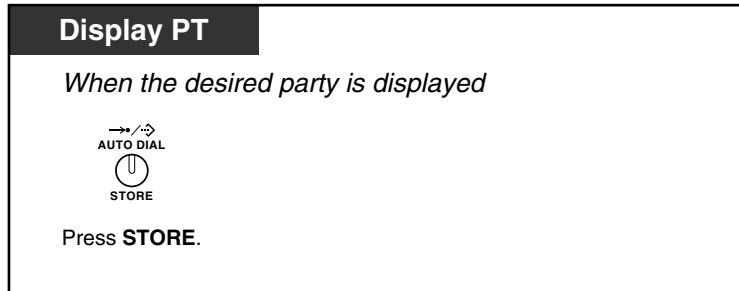
**To store the caller's information in personal speed dialling**

- You can lock your call log display by using an extension PIN (Personal Identification Number), so that you can prohibit access to your logged information (Display Lock). Refer to "3.1.2 Settings on the Programming Mode".
- If a call arrives while you are using the call log, the call log display will be replaced with the caller's information.

### 1.13.2 Using the Directories

You can call using the directories (*Personal Speed Dialling Directory, System Speed Dialling Directory and Extension Number Directory*).

Only personal directories can be stored, edited or deleted on your extension.

If a call arrives while you are using a directory, the display will be replaced with the caller's information.

- Calling with the Directory
- Storing Names and Numbers
- Entering Characters

#### ◆◆ Calling with the Directory

##### To select and call

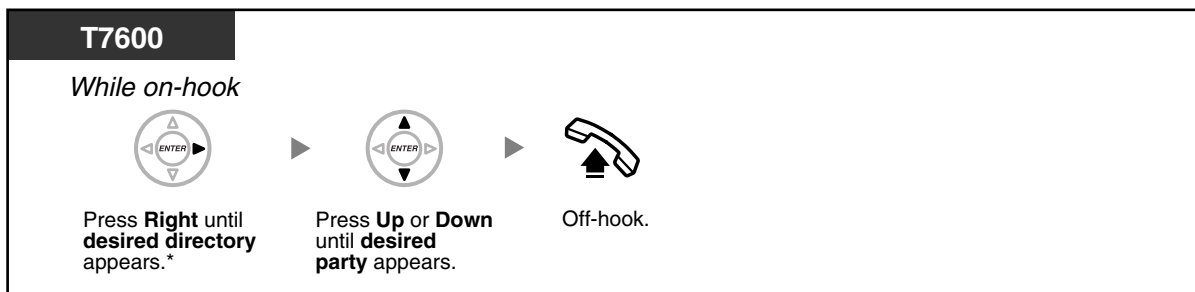

- \* The display order is as follows:  
One time: Personal Speed Dialling Directory  
Two times: System Speed Dialling Directory  
Three times: Extension Number Directory
- To cancel or exit, press the CANCEL or FLASH/RECALL button.
- You can lock your personal speed dialling directory by using an extension PIN (Personal Identification Number), so that you can prohibit access to it (Display Lock). Refer to "3.1.2 Settings on the Programming Mode".



- Directory entries generally should include name and number. If the name is not registered, an entry cannot be displayed.
- The System Speed Dialling Directory can be displayed simply by pressing the AUTO DIAL/STORE button while on-hook.



## ◆◆ Storing Names and Numbers

### To store a Personal Speed Dialling Directory item

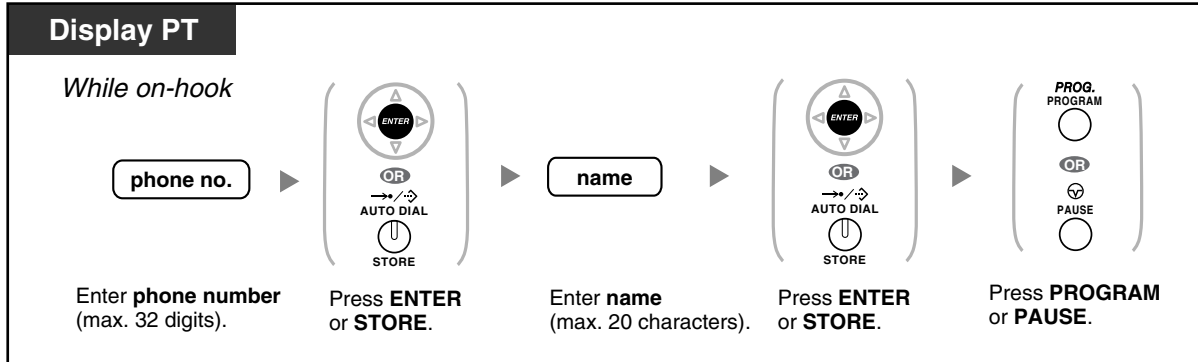

- Telephone numbers and names displayed are stored using the first spare Personal Speed Dialling memory available.
- PS user: Refer to "Operating Instructions" for PS.



- For more details, refer to "To store the names and numbers in personal speed dialling" in "3.1.2 Settings on the Programming Mode".

## ◆◆ Entering Characters

You can enter the following characters. The tables show you the characters available for each button. Table 1 or Table 2 can be programmed.

**Table 1 (Standard mode)**

Times Buttons	1	2	3	4	5	6	7	8	9
1	!	?	"	1					
2	A	B	C	a	b	c	2		
3	D	E	F	d	e	f	3		
4	G	H	I	g	h	i	4		
5	J	K	L	j	k	l	5		
6	M	N	O	m	n	o	6		
7	P	Q	R	S	p	q	r	s	7
8	T	U	V	t	u	v	8		
9	W	X	Y	Z	w	x	y	z	9
0	(Space)	.	,	'	:	;	0		
*	/	+	-	=	<	>	*		
#	\$	%	&	@	(	)	€	£	#

Table 1 (Standard mode for RU model)

Times Buttons	1	2	3	4	5	6	7	8	9
1	!	?	"	1					
2	A	B	C	a	b	c	2		
3	D	E	F	d	e	f	3		
4	G	H	I	g	h	i	4		
5	J	K	L	j	k	l	5		
6	M	N	O	m	n	o	6		
7	P	Q	R	S	p	q	r	s	7
8	T	U	V	t	u	v	8		
9	W	X	Y	Z	w	x	y	z	9
0	(Space)	.	,	'	:	;	0		
*	/	+	-	=	<	>	*		
#	\$	%	&	@	(	)	■	■	#

## 1.13 Using a Display Proprietary Telephone

**Table 2 (Option mode)**

Times Buttons	1	2	3	4	5	6	7	8	9	10	11	12	13	14	15
1	!	?	"	ä	ö	ü	1								
2	A	B	C	a	b	c	À	Á	Â	Ã	Ä	Å	Æ	Ç	2
3	D	E	F	d	e	f	Ð	È	É	Ê	Ë	3			
4	G	H	I	g	h	i	Ì	Í	Î	Ï	4				
5	J	K	L	j	k	l	5								
6	M	N	O	m	n	o	Ñ	Ò	Ó	Ô	Õ	Ö	Ø	Œ	6
7	P	Q	R	S	p	q	r	s	Š	ß	7				
8	T	U	V	t	u	v	Û	Ü	Û	Ü	8				
9	W	X	Y	Z	w	x	y	z	Ý	Ž	9				
0	(Space)	.	,	'	:	;	0								
*	/	+	-	=	<	>	*								
#	\$	%	&	@	(	)	€	£	#						

Table 2 (Option mode for CE model)

Times Buttons	1	2	3	4	5	6	7	8	9	10	11	12	13	14	15
1	!	?	"	ä	ö	ü	1								
2	A	B	C	a	b	c	Á	Â	Ă	Ä	Å	Ć	Ç	Č	2
3	D	E	F	d	e	f	Ď	Ð	É	Ě	Ë	ě	3		
4	G	H	I	g	h	i	Í	Î	4						
5	J	K	L	j	k	l	Ĺ	Ľ	5						
6	M	N	O	m	n	o	Ň	Ń	Ó	Ô	Õ	Ö	6		
7	P	Q	R	S	p	q	r	s	Ř	Ŕ	Š	Ś	Ş	ß	7
8	T	U	V	t	u	v	Ť	Ț	ű	Ú	Ű	Ü	8		
9	W	X	Y	Z	w	x	y	z	Ž	Ż	Ž	Ý	9		
0	(Space)	.	,	'	:	;	0								
*	/	+	-	=	<	>	*								
#	§	%	&	@	(	)	€	£	#						

### 1.13 Using a Display Proprietary Telephone

**Table 2 (Option mode for GR model)**

Times Buttons \	1	2	3	4	5	6	7	8	9
1	!	?	"	1					
2	A	B	Γ	2					
3	Δ	E	Z	3					
4	H	Θ	I	4					
5	K	Λ	M	5					
6	N	Ξ	O	6					
7	Π	P	Σ	7					
8	T	Υ	Φ	8					
9	X	Ψ	Ω	9					
0	(Space)	.	,	'	:	;	0		
*	/	+	-	=	<	>	*		
#	\$	%	&	@	(	)	€	£	#

Table 2 (Option mode for RU model)

Times Buttons	1	2	3	4	5	6	7	8	9	10	11
1	А	Б	В	!	?	"	1				
2	Г	Д	Е	Ё	2						
3	Ж	З	И	Й	3						
4	К	Л	М	4							
5	Н	О	П	5							
6	Р	С	Т	6							
7	У	Ф	Х	7							
8	Ц	Ч	Ш	8							
9	Щ	Ъ	Ы	Ь	9						
0	Э	Ю	Я	(Space)	.	,	'	:	;	0	
*	/	+	-	=	<	>	Г	€	І	İ	*
#	§	%	&	@	(	)	€	І	Ÿ	#	

### 1.13.3 Accessing System Features (System Feature Access)

You can access a feature with the "Feature Access" menu.

To access "Feature Access" menu and select the feature

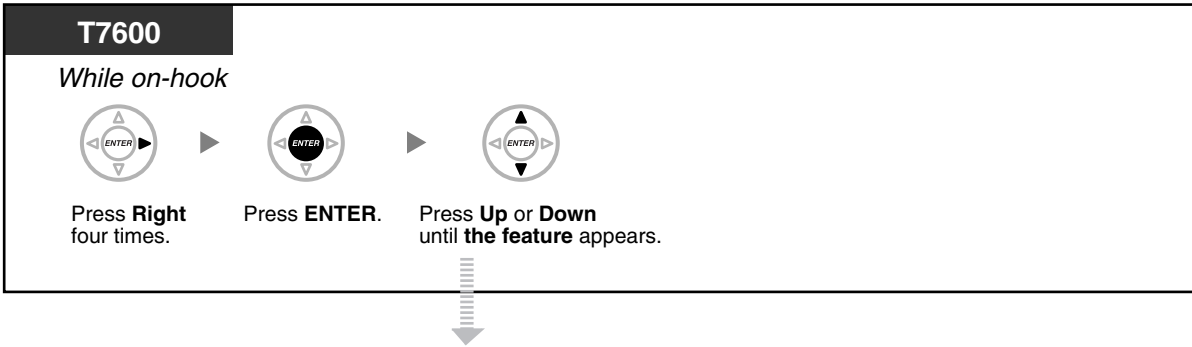

Features	Refer to
Automatic Callback Busy Cancel	1.2.4 When the Dialed Line is Busy or There is No Answer
Group Call Pickup	1.3.3 Answering a Call Ringing at Another Telephone (Call Pickup)
Directed Call Pickup	1.3.3 Answering a Call Ringing at Another Telephone (Call Pickup)
Paging	1.7.1 Paging
Doorphone Call	1.10.1 If a Doorphone/Door Opener is Connected
Door Open	1.10.1 If a Doorphone/Door Opener is Connected
External Relay	1.10.2 If an External Relay is Connected
External Background Music	2.1.4 Turning on the External Background Music (BGM)



---

## **Section 2**

# ***Manager Operation***

*This chapter shows the manager how to control the other extensions or the PBX.*

## 2.1 Control Features

### 2.1.1 Extension Control

The manager extension can control the settings of other extensions.

- Changing the Settings of Other Extensions

#### ◆◆ Changing the Settings of Other Extensions

##### To lock/unlock other extensions (Remote Extension Dial Lock)

This feature is also known as Remote Station Lock Control.

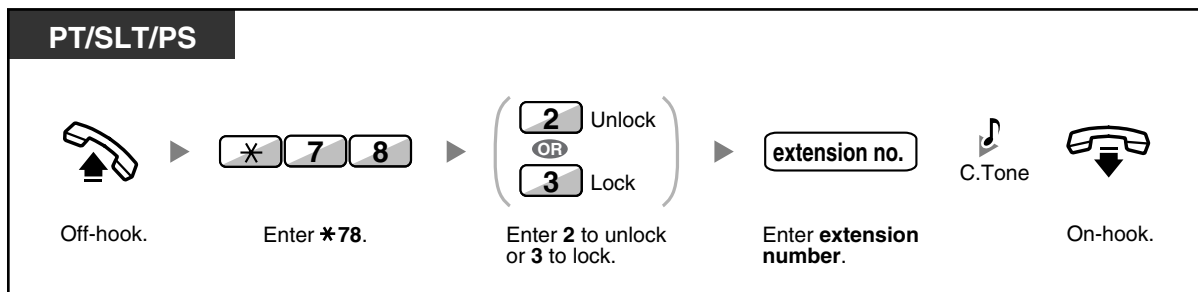

- The manager can use Remote Extension Dial Lock to unlock any extension, whether that extension was locked remotely (Remote Extension Dial Lock) or from the extension itself (Extension Dial Lock).

## 2.1.2 Time Service Mode Control

The manager extension or the preprogrammed extension can change the time mode (Day, Lunch, Break or Night).

There are two methods (Automatic or Manual) of changing the time modes.

**Automatic:** enables the time mode for each day of the week to change automatically. You may also change it manually.

**Manual:** enables to change a mode in manual as follows.

### To change the time mode (Day/Night/Lunch/Break)

PT/PS

*While on-hook*



(Time Service  
Day/Night/  
Lunch/Break)

Press **Time Service (Day/Night/Lunch/Break)** until the desired mode appears.

PT/SLT/PS



Off-hook.

Enter \*780.

0 Day

1 Night

2 Lunch

3 Break

Enter 0 to 3 as you desire.

C.Tone



On-hook.

### To select the time service switching mode (Automatic/Manual)

PT/PS

*While on-hook*



(Time Service  
Switching Mode  
Automatic/Manual)

Press **Time Service Switching Mode (Automatic/Manual)**.

User Manual | 175

## 2.1 Control Features

---



- Besides the time mode, there is Holiday mode. It can change mode once on a specified date.
- The Time Service (Day/Night/Lunch/Break) button light shows the current status as follows:
  - Off:** Day mode
  - Green on:** Lunch mode
  - Flashing green:** Break mode
  - Red on:** Night mode
  - Flashing red:** Holiday mode
- The Time Service Switching Mode (Automatic/Manual) button light shows the current status as follows:
  - Off:** Automatic
  - Red on:** Manual



### Customising Your Phone

- 3.1.3 Customising the Buttons  
Create or edit a Time Service (Day/Night/Lunch/Break) button or a Time Service Switching Mode (Automatic/Manual) button.

## 2.1.3 Restriction Level Control (Dial Tone Transfer)

The manager extension can change the restriction level, permitting an extension to make a call.

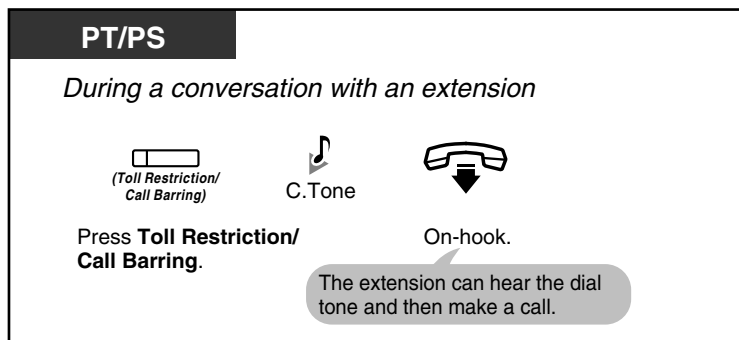

- The restriction level is changed to the preprogrammed level of Toll Restriction/Call Barring button.



### Customising Your Phone

- 3.1.3 Customising the Buttons  
Create or edit a Toll Restriction/Call Barring button.

## 2.1.4 Turning on the External Background Music (BGM)

The manager extension can select and broadcast background music in the office through external speakers.

### To select and start/stop the background music

<For users of KX-TDA100/KX-TDA200/KX-TDA600>

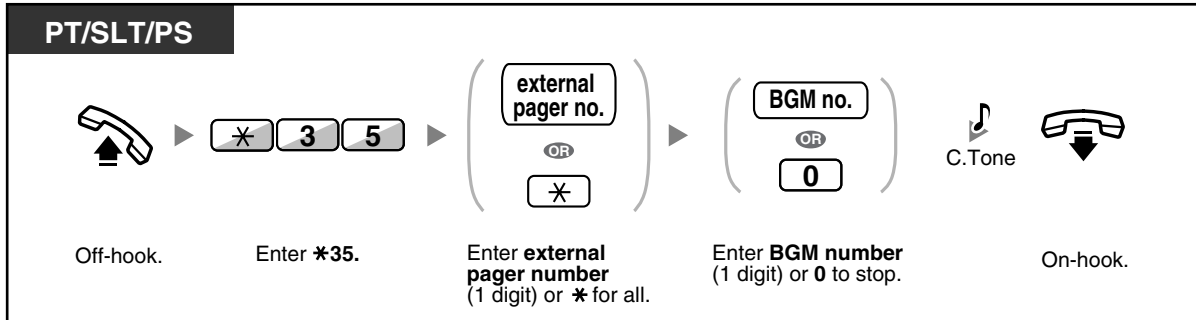

<For users of KX-TDA30>

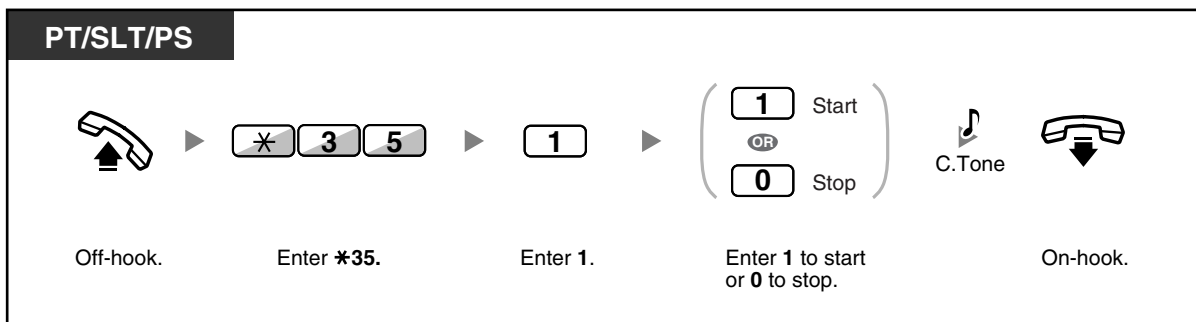

## 2.1.5 Recording Outgoing Messages (OGM)

The manager extension can record three kinds of greeting messages (OGM) as follows:

1. **DISA message:** Used to greet and guide callers so that they access an extension user group or outside party without operator assistance.
2. **Incoming Call Distribution Group message:** Used to greet and guide callers to an incoming call distribution group.
3. **Timed Reminder message:** Used for a wake-up call message when the extension answers the Timed Reminder.



All messages have their own extension numbers. You can select the desired message. You have two methods for recording a message. One is recorded using the handset, and the other is recorded from an external BGM (MOH) port.

### To record

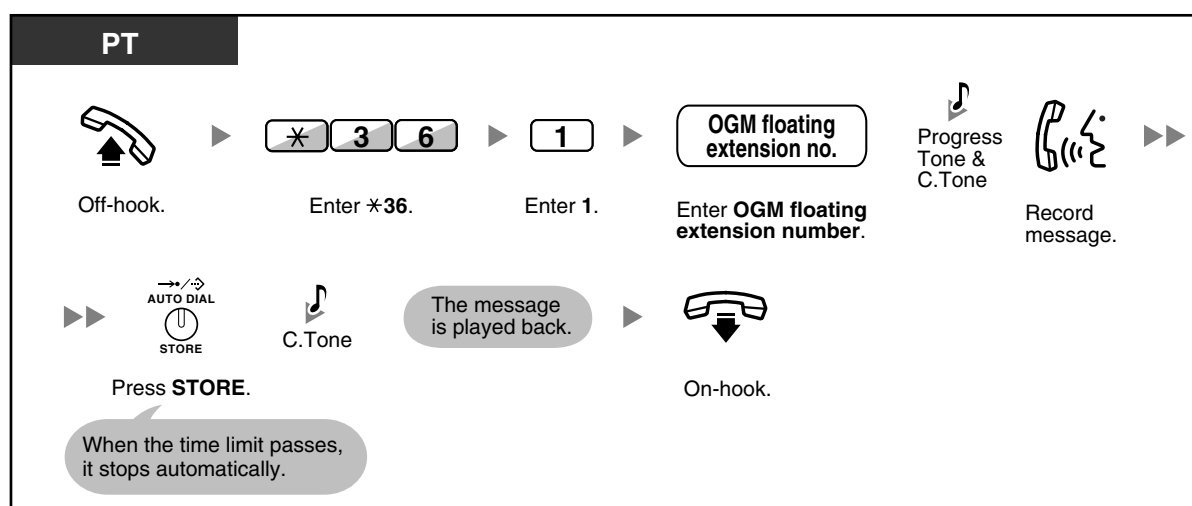

### To play back

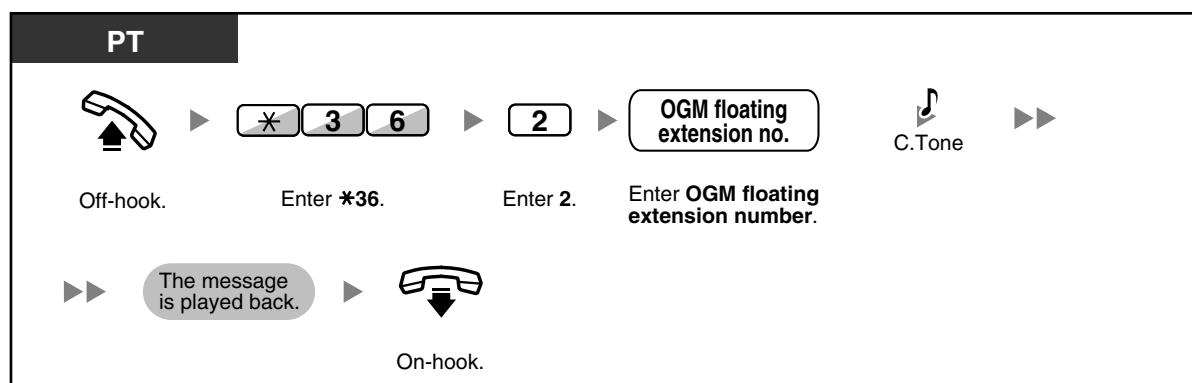

**To record from an external BGM (MOH) port**  
 <For users of KX-TDA100/KX-TDA200/KX-TDA600>

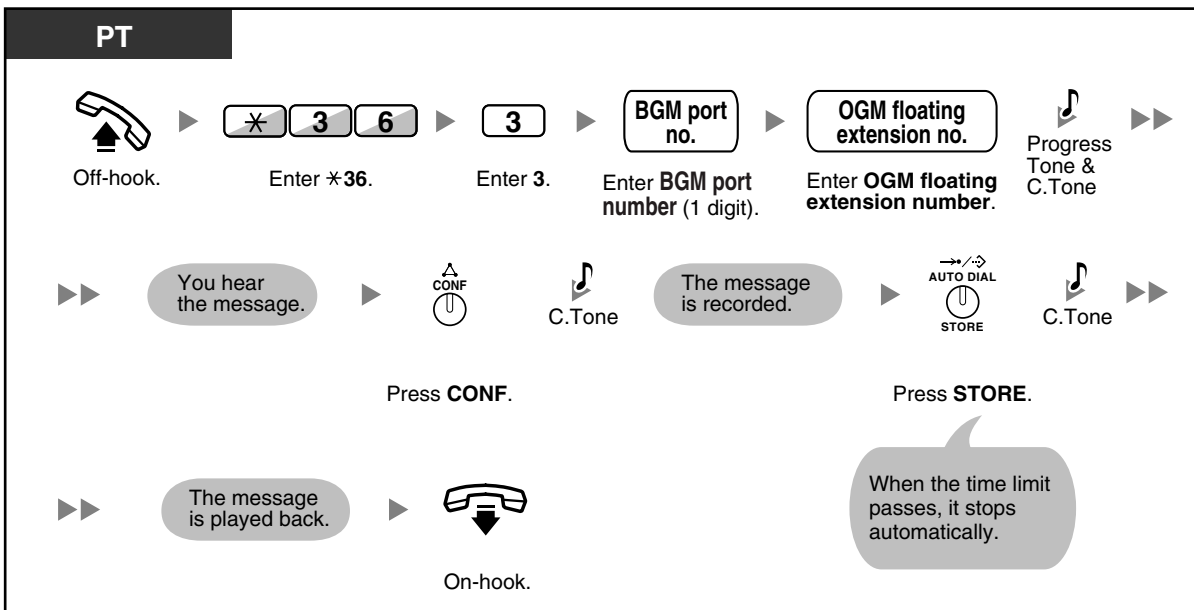

<For users of KX-TDA30>

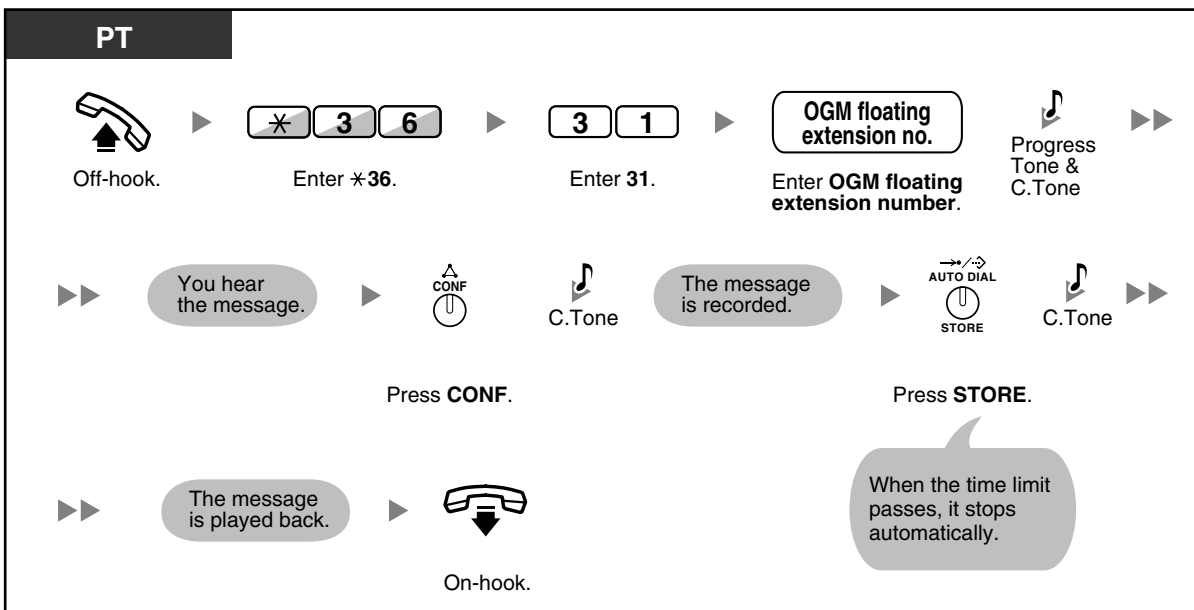



### To clear the message

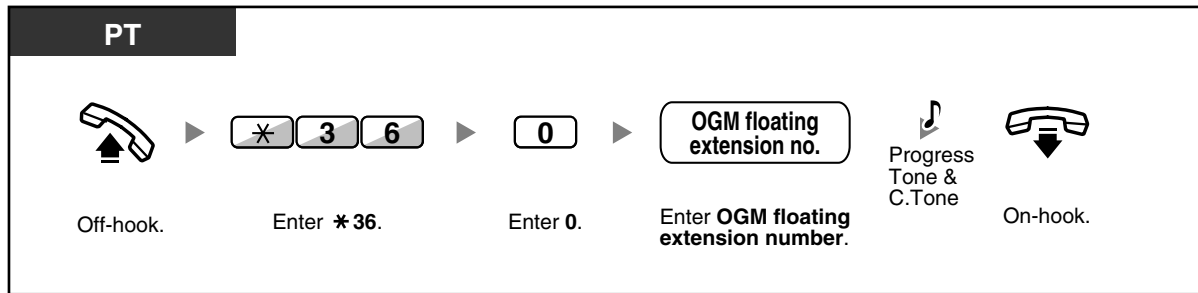

- Record voice messages only; avoid the recording of music.



- The default of OGM floating extension numbers is 5xx (xx: two-digit number of message).

## 2.1.6 Allowing Users to Seize an Unavailable Outside Line (Trunk Busy Out)

When a problem is found on a certain outside line, the PBX automatically makes it unavailable for use temporarily. The manager can manually enable the outside line and allow users to use it again.

### To re-enable an outside line

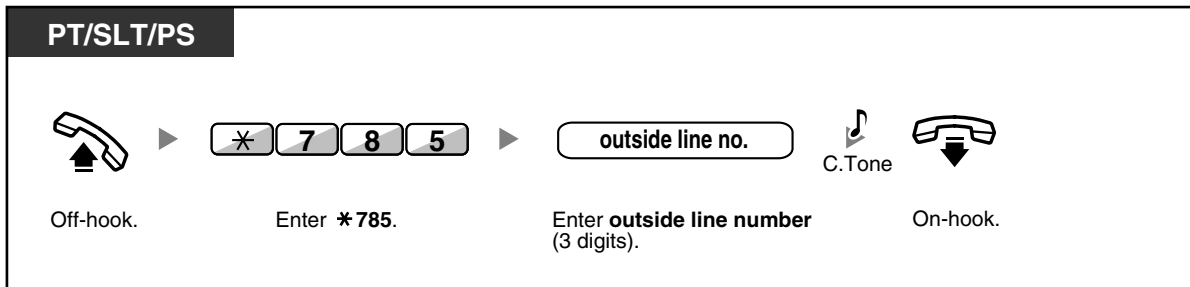

- In some countries/areas, the PBX may not be able to automatically make a faulty outside line unavailable for use.

## 2.1.7 Releasing Network Direct Station Selection (NDSS) Monitor

NDSS buttons can be customised on any extension connected to your PBX. An NDSS button allows an extension user to monitor another extension connected to another PBX in a private network. The NDSS button light shows the current status of the monitored extension in the same way as a DSS button. When it becomes unnecessary to monitor an extension connected to another PBX, the manager can stop the PBX from monitoring it. Any NDSS buttons set to monitor that extension will also stop monitoring.

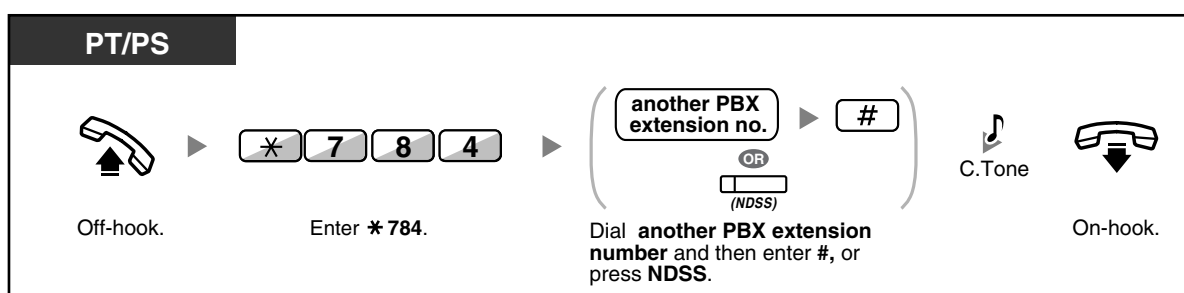

- To restart monitoring of an extension after performing this operation, go off-hook, press the corresponding NDSS button, and go on-hook.



### Customising Your Phone

- 3.1.3 Customising the Buttons  
Create or edit a Network Direct Station Selection (NDSS) button.

## 2.1 Control Features

---

---

## **Section 3**

# ***Customising Your Phone & System***

*This chapter shows you how to customise your individual telephone or PBX according to your needs. Find the desired setting and program as necessary.*

## 3.1 Customising Your Phone (Personal Programming)

### 3.1.1 Customising Your Phone (Personal Programming)

You can customise your telephone features. For example, you can change the initial settings or button features according to your needs.

- Assigning an Extension PIN to Your Extension (Extension PIN [Personal Identification Number])



- If you change your desk and extension, refer to "1.12.1 Using the Same Settings as Your Previous Extension (Walking Extension)".

#### ◆◆ Assigning an Extension PIN to Your Extension (Extension PIN [Personal Identification Number])

You can assign a password to each extension.  
The following features require an extension PIN.

1. Screening calls (Live Call Screening [LCS])
2. Prohibiting other people from seeing your personal speed dialling directory, call log, SVM log, and from playing back the voice messages in your message box (Display Lock)
3. Using the same settings as your extension at other extensions (Walking Extension)
4. Remote Control Operation (Walking COS)
5. Extension Dial Lock Clear

#### To set

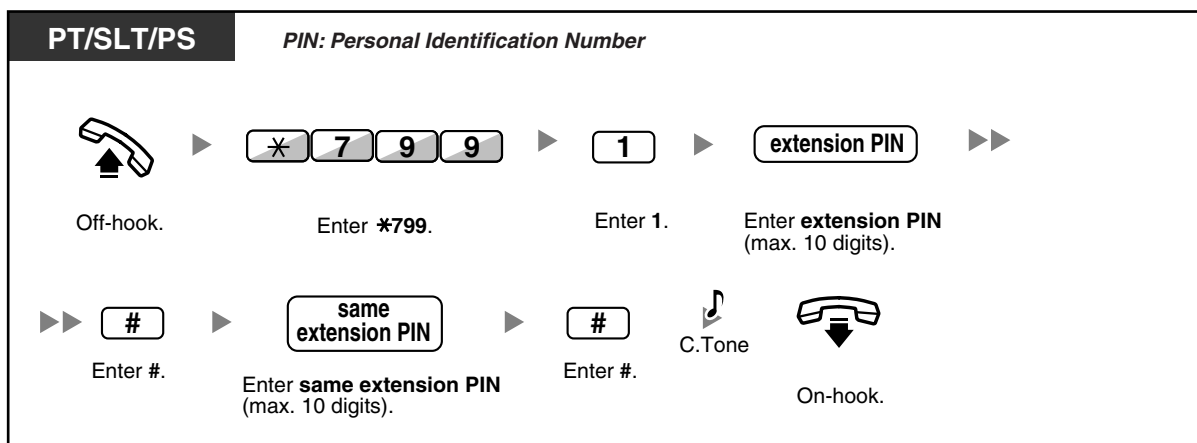

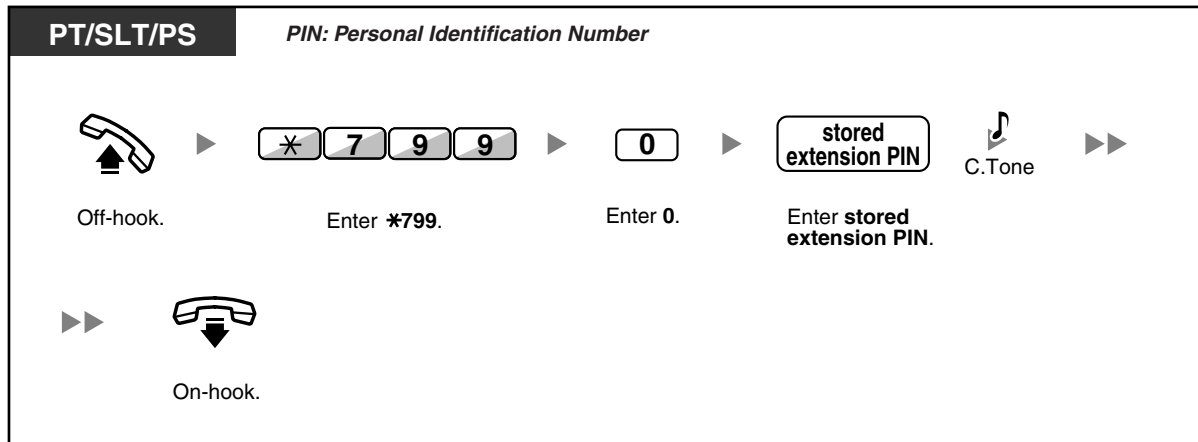
**To cancel**

- **WARNING**  
 There is a risk that fraudulent telephone calls will be made if a third party discovers your password (extension PIN).  
 The cost of such calls will be billed to the owner/renter of the PBX.  
 To protect the PBX from this kind of fraudulent use, we strongly recommend:
  - a) Keeping your PIN secret.
  - b) Selecting a complex, random PIN that cannot be easily guessed.
  - c) Changing your PIN regularly.
- Valid numbers for an extension PIN are "0" through "9".
- If the wrong extension PIN is entered a preprogrammed number of times, the PIN is locked.
- If you forget your extension PIN or your extension PIN is locked, your manager can clear the extension PIN and extension PIN lock.

### 3.1.2 Settings on the Programming Mode

You can programme features using the programming mode.

- Setting Features
- Clearing Features



- To exit at any time, lift the handset.
- To enter the programming mode when using a PS, refer to "Operating Instructions" for PS.

#### ◆◆ Setting Features

The default settings are shown in bold letters. For later reference, place a check mark in the boxes below to indicate your customised setting.

**Notice**

The default value may vary depending on country/area.

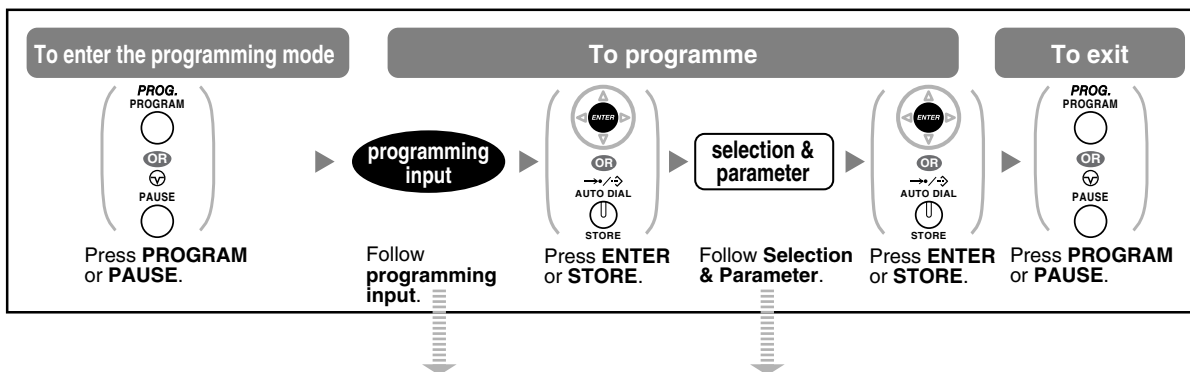

Item	Programming Input	Selection & Parameter
Your extension information	<input type="text" value="0"/> <input type="text" value="0"/>	PT: The display shows the PBX or shelf number, slot number and port number. <example for users of KX-TDA30/KX-TDA100/KX-TDA200> EXT1050:10308 PBX no. <input type="text" value="1"/> <input type="text" value="1"/> <input type="text" value="1"/> Port no. Slot no. <example for users of KX-TDA600> EXT2100:20101 Shelf no. <input type="text" value="1"/> <input type="text" value="1"/> <input type="text" value="1"/> Port no. (1-4) Slot no. PS: The display shows the PS number. <example> EXT3001:99001 PS no.



Item	Programming Input	Selection & Parameter	
Preferred display contrast level from the 4 levels available (Display Contrast Selection)*1	0 1	1	<input type="checkbox"/> Light
		2	<input type="checkbox"/> Little Light
		3	<input type="checkbox"/> <b>Little Dark</b>
		4	<input type="checkbox"/> Dark
Which display language do you prefer? (Display Language Selection)	0 2	1	<input type="checkbox"/> <b>English</b>
		2	<input type="checkbox"/> 2nd Language
		3	<input type="checkbox"/> 3rd Language
		4	<input type="checkbox"/> 4th Language
		5	<input type="checkbox"/> 5th Language
Would you like the call duration to be shown automatically on the display when answering an outside call? (Display Switching Mode)	0 3	0	<input type="checkbox"/> No—Manual (The display keeps showing all of the outside caller's information unless you change it to the call duration manually.)
		1	<input type="checkbox"/> <b>Yes—Automatic (The first line of the display will change to the call duration automatically when you answer an outside call.)</b>
Would you like to turn on the display backlight of the KX-T7633/KX-T7636? (Display Backlight Selection)*1	0 4	0	<input type="checkbox"/> <b>Yes—ON in use</b>
		1	<input type="checkbox"/> Yes—always ON
		2	<input type="checkbox"/> No—always OFF
Would you like to dial a preset number simply by going off-hook?	1 1	desired no. (max. 32 digits)	
	1 2	0	<input type="checkbox"/> <b>Do not use</b>
		1	<input type="checkbox"/> Use
Should you prevent your number being displayed on the called party's telephone? (Calling Line Identification Restriction [CLIR])	1 3	0	<input type="checkbox"/> <b>No—Allows your number to be displayed</b>
		1	<input type="checkbox"/> Yes—Prevent your number being displayed

### 3.1 Customising Your Phone (Personal Programming)

Item	Programming Input	Selection & Parameter	
Which number should be displayed on the called and calling party's telephone? (Calling/Connected Line Identification Presentation [CLIP/COLP])	1 4	0	<b>Caller ID assigned to your extension</b>
		1	Caller ID assigned on the outside line being used
Which do you prefer to seize when you go off-hook to make calls? (Preferred Line Assignment—Outgoing)	1 9	0	<input type="checkbox"/> No line
		1	<input type="checkbox"/> An idle outside line
		2 + CO button no. (01–36)* <sup>2</sup> or [ ] (CO)	<input type="checkbox"/> A CO/ICD Group button
		3 or INT* INTERCOM / [ ] (PDN)	<input type="checkbox"/> <b>Intercom</b> (On a PDN extension, an idle PDN button is selected when going off-hook.)
Which line do you prefer to answer when you go off-hook? (Preferred Line Assignment—Incoming)	2 0	0	<input type="checkbox"/> No line
		1	<input type="checkbox"/> <b>The longest ringing line (when multiple calls arrive)</b>
		2 + CO button no. (01–36)* <sup>2</sup> or [ ] (CO)	<input type="checkbox"/> A CO/ICD Group button
		3 / [ ] (PDN)	<input type="checkbox"/> A PDN button
How do you prefer to receive an intercom call? (Alternate Receiving—Ring/Voice)* <sup>1</sup>	2 1	0	<input type="checkbox"/> <b>Ring (Tone Call)</b>
		1	<input type="checkbox"/> Directly—The party's voice is heard without ringing.
		2	<input type="checkbox"/> Ring only—Prohibiting the caller switching to the voice mode.

Item	Programming Input	Selection & Parameter	
Should the single line telephone in parallel ring? (Paralleled Telephone)*1*3	2 2	0	<input type="checkbox"/> No—The telephone will not ring.
		1	<input type="checkbox"/> <b>Yes—The telephone will ring.</b>
Do you prefer to answer a call without going off-hook regardless of the AUTO ANS button status? (Forced Answerback Selection)*1	2 3	0	<input type="checkbox"/> <b>No—Disable</b>
		1	<input type="checkbox"/> Yes—Enable
Which service do you prefer when a calling party is recording a message in your mailbox? (Live Call Screening Mode Set)*1	2 5	0	<input type="checkbox"/> You can monitor the message through the telephone speaker. <b>(Hands-free mode)</b>
		1	<input type="checkbox"/> Only an alarm tone is heard. (Private mode)
Would you like to keep recording after answering the call in the LCS mode? (LCS Mode Set [After Answering])	2 6	0	<input type="checkbox"/> <b>No—Stop recording</b>
		1	<input type="checkbox"/> Yes—Keep recording
Would you prefer to automatically hear a call waiting tone when you receive a call while already on the phone? (Automatic Call Waiting)*4	3 0	0	<input type="checkbox"/> <b>No (OFF)</b>
		1	<input type="checkbox"/> Yes (ON)
How would you prefer to receive call waiting notifications for intercom calls? (Manual Call Waiting)	3 1	0	<input type="checkbox"/> <b>No call (OFF)</b>
		1	<input type="checkbox"/> Tone (BSS)
		2	<input type="checkbox"/> Voice announcement through the built-in speaker (OHCA)*5
		3	<input type="checkbox"/> Voice announcement through the handset (Whisper OHCA)*5
Which type of call waiting tone do you prefer? (Call Waiting Tone Type Selection)	3 2	0	<input type="checkbox"/> <b>Tone 1</b>
		1	<input type="checkbox"/> Tone 2

### 3.1 Customising Your Phone (Personal Programming)

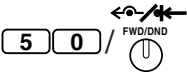
Item	Programming Input	Selection & Parameter	
Would you like to show a message on the caller's telephone display? (Absent Message)	4 0	0	<input type="checkbox"/> No—Off
		message no. (1–8)	<input type="checkbox"/> Yes—Shows the selected message.
		9	<input type="checkbox"/> Yes—Shows your personal message.
Creating your personal message (Personal Absent Message)	4 1	message (max. 16 characters)	
To forward or refuse some or all of your incoming calls (Call Forwarding [FWD])/Do Not Disturb [DND])	 5 0 / (for both calls) 5 1 (for outside calls) 5 2 (for intercom calls)	0	<input type="checkbox"/> Off
		1	<input type="checkbox"/> Do Not Disturb (DND)
		2 + desired no. (max. 32 digits)	<input type="checkbox"/> All—Forward all calls
		3 + desired no. (max. 32 digits)	<input type="checkbox"/> Busy—Forwarded when your extension is busy.
		4 + desired no. (max. 32 digits)	<input type="checkbox"/> No Answer—Forwarded when you do not answer.
		5 + desired no. (max. 32 digits)	<input type="checkbox"/> Busy/No Answer—Forwarded when you do not answer or when your extension is busy.
To set the timer for "No Answer" and "Busy/No Answer" (FWD N/A Timer)	5 3	<input type="text"/> (0–120) seconds (Default: 15 seconds)	
Should you prohibit other people from picking up your calls? (Call Pickup Deny)	6 0	0	<input type="checkbox"/> No—Allow
		1	<input type="checkbox"/> Yes—Deny
Do you use the headset? (Headset Operation) <sup>*1*3</sup>	6 1	0	<input type="checkbox"/> No—Headset off
		1	<input type="checkbox"/> Yes—Headset on
Do you prohibit other people from joining your conversation? (Executive Busy Override Deny)	6 2	0	<input type="checkbox"/> No—Allow
		1	<input type="checkbox"/> Yes—Deny

Item	Programming Input	Selection & Parameter	
Would you like to prohibit paging announcements? (Paging Deny)* <sup>1</sup>	6 3	0	<input type="checkbox"/> No—Allow
		1	<input type="checkbox"/> Yes—Deny
Do you prefer to hear the key pad tone? (Key Pad Tone Set)* <sup>1</sup>	6 4	0	<input type="checkbox"/> No—Off
		1	<input type="checkbox"/> Yes—On
Do you want background music through your telephone speaker while on-hook? (Background Music [BGM])* <sup>1</sup>	6 5	0	<input type="checkbox"/> No—Off
		KX-TDA100/KX-TDA200/KX-TDA600: 1 + BGM no. (1 digit) KX-TDA30: 1 1	<input type="checkbox"/> Yes—On
Would you like to set your extension PIN or change a stored extension PIN to new one? (Extension PIN [Personal Identification Number])	9 0	extension PIN (max. 10 digits) + ENTER/STORE + same extension PIN	To set an extension PIN
		stored extension PIN + new extension PIN (max. 10 digits) + ENTER/STORE + same extension PIN	To change a stored extension PIN to new one
To prevent other people from using your telephone (Extension Dial Lock)	9 1	extension PIN (max. 10 digits) + 0	<input type="checkbox"/> To unlock
		extension PIN (max. 10 digits) + 1	<input type="checkbox"/> To lock
To prevent other people from seeing your personal speed dialling directory, call log, SVM log, and from playing back the voice messages in your message box (Display Lock)* <sup>1</sup>	9 2	extension PIN (max. 10 digits) + 0	<input type="checkbox"/> To unlock
		extension PIN (max. 10 digits) + 1	<input type="checkbox"/> To lock

### 3.1 Customising Your Phone (Personal Programming)

Item	Programming Input	Selection & Parameter	
Do you prefer to set the One-touch dialling only? (One-touch Dialling Assignment Mode Selection)	<input type="button" value="#"/> <input type="button" value="*"/>	<input type="button" value="0"/>	<input type="checkbox"/> No—Normal (Any Flexible CO buttons can be modified.)
		<input type="button" value="1"/>	<input type="checkbox"/> Yes—Only One-touch dialling buttons can be modified. However, to modify them, there is no need to enter "2" before the number.

\*1: Not available for a PS

\*2: CO button numbers (25–36) are available only when the Add-on Key Module is set up to your telephone.

\*3: Not available for the KX-T7665

\*4: This setting applies to both outside and intercom calls. For intercom calls, this feature must be enabled through system programming.

\*5: Only available for certain digital proprietary telephones.



- **WARNING**  
**There is a risk that fraudulent telephone calls will be made if a third party discovers your password (extension PIN). The cost of such calls will be billed to the owner/renter of the PBX. To protect the PBX from this kind of fraudulent use, we strongly recommend:**
  - a) Keeping your PIN secret.
  - b) Selecting a complex, random PIN that cannot be easily guessed.
  - c) Changing your PIN regularly.
- After the programme number is entered, the programme title is displayed. The programming screen can be changed with the Navigator Key (Up or Down).



- You can select the parameter with the Navigator Key (Up or Down) instead of entering a number.

**To store the names and numbers in personal speed dialling**

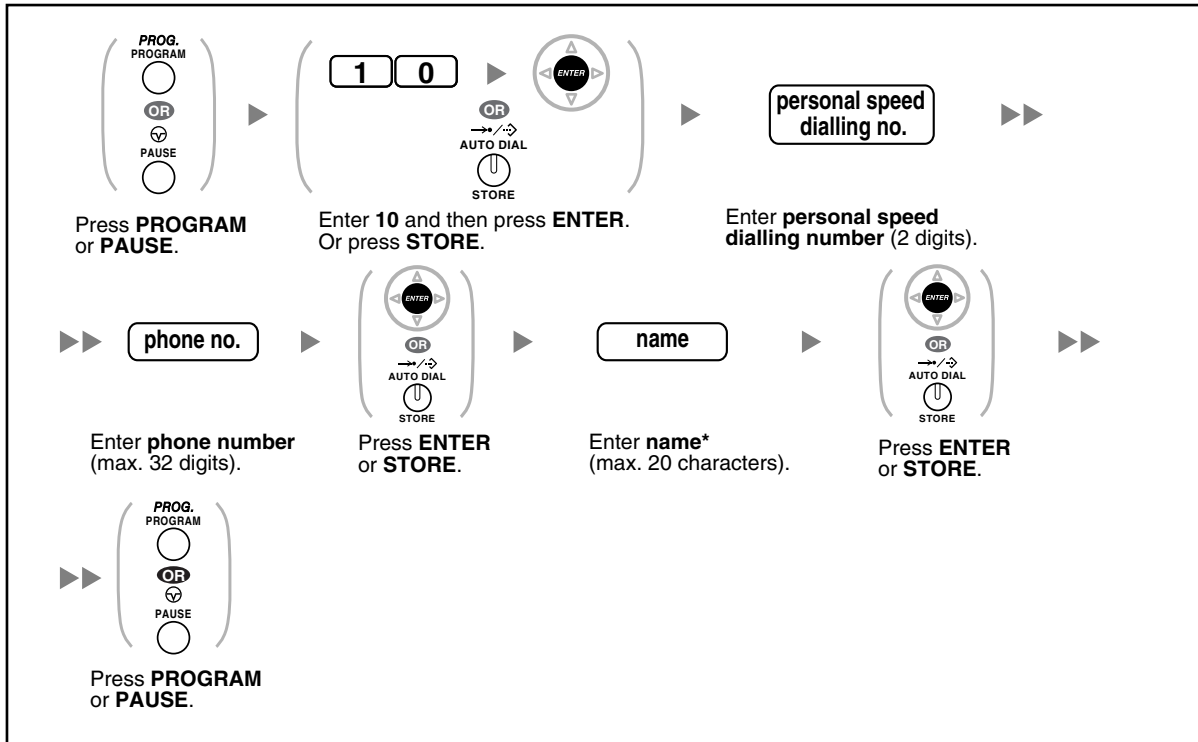

- \* To enter characters, refer to "Entering Characters".
- The number of personal speed dialling numbers available per extension (default: 10 numbers stored in locations "00" to "09") can be increased to a maximum of 100.

### 3.1 Customising Your Phone (Personal Programming)

#### To edit the names and numbers of personal speed dialling

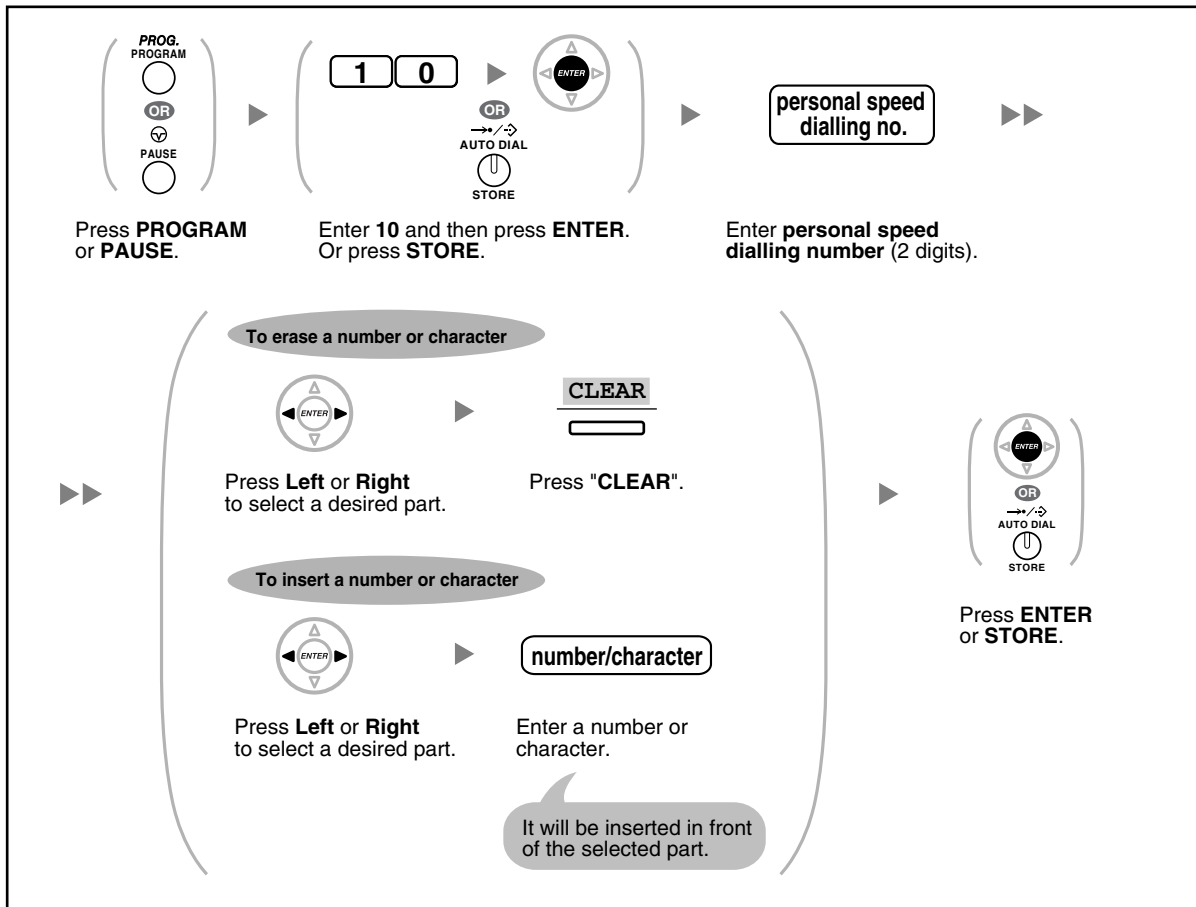



## ◆◆ Clearing Features

You can clear or change to features as follows:

Features	Default Setting
Display Switching Mode	<b>Automatic</b>
Hot Line	<b>Off</b>
Calling Line Identification Restriction [CLIR]	<b>Allow</b>
Calling/Connected Line Identification Presentation [CLIP/COLP]	<b>Caller ID assigned on your extension</b>
Preferred Line Assignment—Outgoing	<b>Intercom</b>
Preferred Line Assignment—Incoming	<b>The longest ringing line</b>
Alternate Receiving—Ring/Voice	<b>Ringing (Tone Call)</b>
Paralleled Telephone	<b>Paired SLT will ring</b>
Forced Answerback Selection	<b>Disable</b>
Live Call Screening Mode Set	<b>Hands-free mode</b>
LCS Mode Set [After Answering]	<b>Stop recording</b>
Automatic Call Waiting	<b>Enable</b>
Manual Call Waiting—Intercom Calls	<b>Disable (No call/No tone)</b>
Call Waiting Tone Type Selection	<b>Tone 1</b>
Absent Message	<b>Off</b>
Personal Absent Message	<b>Cleared</b>
Call Forwarding [FWD]/Do Not Disturb [DND]—Intercom/Outside Calls	<b>Off</b>
FWD N/A Timer	<b>15 seconds</b>
Call Pickup Deny	<b>Allow</b>
Headset Operation	<b>Headset off</b>
Executive Busy Override Deny	<b>Allow</b>
Paging Deny	<b>Allow</b>
Key Pad Tone Set	<b>On</b>
Background Music [BGM]	<b>Off</b>
Data Line Security	<b>Off</b>
Connected Line Identification Restriction [COLR]	<b>Allow</b>
Log-in/Log-out	<b>Log-in</b>
Message Waiting	<b>Off</b>
Timed Reminder	<b>Cleared</b>

### 3.1 Customising Your Phone (Personal Programming)

#### To set

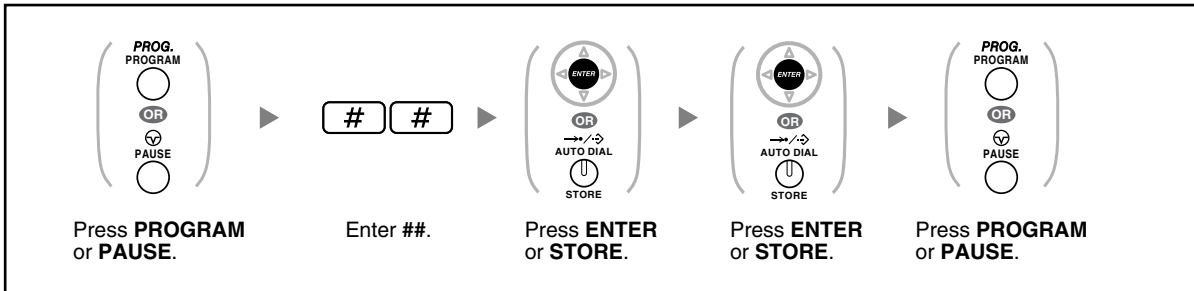

- If you do not desire that the Call Waiting, FWD/DND or Hot Line to be cleared by this feature, please ask your dealer.

### 3.1.3 Customising the Buttons

You can change the flexible CO buttons/DSS buttons, and programmable feature (PF) buttons on PTs, DSS Consoles, Add-on Key Modules, and PSs to the following feature buttons. For example, if your telephone has more CO buttons than available outside lines, you may change unused CO buttons to one-touch buttons.



- To enter the programming mode when using a PS, refer to "Operating Instructions" for PS.

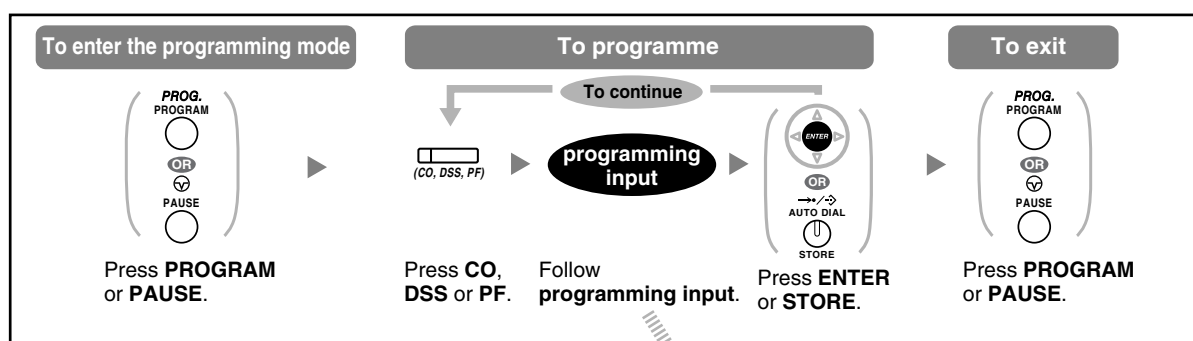

Buttons	Programmable Button			Programming Input
	CO	DSS	PF	
Loop-CO (L-CO)	✓	✓		<b>*</b>
Group-CO (G-CO)	✓	✓		<b>#</b> + Outside line group no. (2 digits)
Single-CO (S-CO)	✓	✓		<b>0</b> + Outside line no. (3 digits)
Direct Station Selection (DSS)	✓	✓		<b>1</b> + Extension no.
One-touch Dialling* <sup>1</sup>	✓	✓	✓	<b>2</b> <sup>*2</sup> + Desired no. (max. 32 digits)
Incoming Call Distribution Group (ICD Group)	✓	✓		<b>3</b> <b>0</b> + Incoming call distribution group extension no. (+ <b>#</b> + delayed ringing time [0-7]) <sup>*3</sup>
Message	✓	✓		<b>4</b> <b>0</b>
Message for Another Extension	✓	✓		<b>4</b> <b>0</b> + Extension no./Incoming call distribution group extension no.
Call Forwarding (FWD)/Do Not Disturb (DND)—Both calls	✓	✓		<b>4</b> <b>1</b>
FWD/DND—Outside calls	✓	✓		<b>4</b> <b>2</b>

### 3.1 Customising Your Phone (Personal Programming)

Buttons	Programmable Button			Programming Input
	CO	DSS	PF	
FWD/DND—Intercom calls	✓	✓		<b>4</b> <b>3</b>
Group FWD—Both calls	✓	✓		<b>4</b> <b>4</b> + Incoming call distribution group extension no.
Group FWD—Outside calls	✓	✓		<b>4</b> <b>5</b> + Incoming call distribution group extension no.
Group FWD—Intercom calls	✓	✓		<b>4</b> <b>6</b> + Incoming call distribution group extension no.
Account	✓	✓		<b>4</b> <b>8</b>
Conference	✓	✓		<b>4</b> <b>9</b>
Terminate	✓	✓		<b>5</b> <b>0</b>
External Feature Access (EFA)	✓	✓		<b>5</b> <b>1</b>
Call Charge Reference	✓	✓		<b>5</b> <b>2</b>
Call Park	✓	✓		<b>5</b> <b>3</b> + Parking zone no. (2 digits)
Call Park (Automatic Park Zone)	✓	✓		<b>5</b> <b>3</b> <b>*</b>
Call Log* <sup>4</sup>	✓	✓		<b>5</b> <b>4</b>
Call Log for ICD Group* <sup>4</sup>	✓	✓		<b>5</b> <b>4</b> + Incoming call distribution group extension no.
Log-in/Log-out	✓	✓		<b>5</b> <b>5</b>
Log-in/Log-out of a specified group	✓	✓		<b>5</b> <b>5</b> + Incoming call distribution group extension no.
Log-in/Log-out for all groups	✓	✓		<b>5</b> <b>5</b> <b>*</b>
Hurry-up	✓	✓		<b>5</b> <b>6</b> + Incoming call distribution group extension no.
Wrap-up	✓	✓		<b>5</b> <b>7</b>
System Alarm* <sup>4</sup>	✓	✓		<b>5</b> <b>8</b>
Time Service (Day/Night/Lunch/Break)	✓	✓		<b>5</b> <b>9</b> + 0/1/2/3* <sup>5</sup> (+ <b>#</b> + Tenant no.)

Buttons	Programmable Button			Programming Input
	CO	DSS	PF	
Answer* <sup>4</sup>	✓	✓		[6] [0]
Release* <sup>4</sup>	✓	✓		[6] [1]
Toll Restriction/Call Barring	✓	✓		[6] [2] + Toll Restriction/Call Barring Level (1–7)
ISDN Service* <sup>6</sup>	✓	✓		[6] [3] + Desired no. (max. 32 digits)
Calling Line Identification Restriction (CLIR)	✓	✓		[6] [4]
Connected Line Identification Restriction (COLR)	✓	✓		[6] [5]
ISDN-Hold	✓	✓		[6] [6]
Headset* <sup>4,7</sup>	✓	✓		[6] [7]
Time Service Switching Mode (Automatic/Manual)	✓	✓		[6] [8] (+ Tenant no.)
Network Direct Station Selection (NDSS)* <sup>8</sup>	✓	✓		[6] [9] + Another PBX extension no.
CTI	✓			[7] [0]
Primary Directory Number (PDN)* <sup>9</sup>	✓			[7] [1]
Secondary Directory Number (SDN)* <sup>9</sup>	✓	✓		[7] [2] + Extension no. + [#] + delayed ringing time (0–7)* <sup>10</sup>
Check-in* <sup>4</sup>	✓	✓		[8] [0]
Check-out* <sup>4</sup>	✓	✓		[8] [1]
Two-way Record* <sup>11</sup>	✓	✓		[9] [0] + Voice mail floating extension no.* <sup>12</sup>
Two-way Transfer* <sup>11</sup>	✓	✓		[9] [1] + Voice mail floating extension no.* <sup>12</sup>
One-touch Two-way Transfer* <sup>11</sup>	✓	✓		[9] [1] + Voice mail floating extension no.* <sup>12</sup> + # + Extension no./Incoming call distribution group extension no.
Live Call Screening (LCS)* <sup>11</sup>	✓	✓		[9] [2]
Voice Mail Transfer* <sup>11</sup>	✓	✓		[9] [4] + Voice mail floating extension no.* <sup>12</sup>

### 3.1 Customising Your Phone (Personal Programming)

---



- \*1 "×", "#", FLASH/RECALL, PAUSE, Secret (INTERCOM) and TRANSFER can also be stored.  
If you do not want to display the stored number when making a call, press the Secret (INTERCOM) button before and after the numbers you wish to conceal.  
If you store an outside party's number, you should first store a line access number.  
If you need to enter an account code, you can enter the specified account code before the line access number.  
<Example>

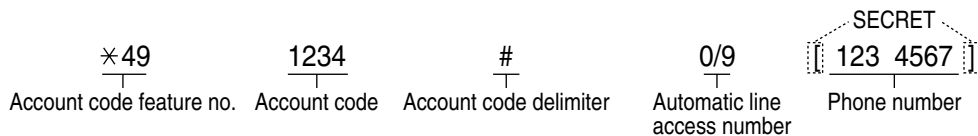

- \*2 For a PF button, "2" is not required to enter before the desired number.
- \*3 Depending on the settings of your PBX, you may be required to enter delayed ringing time (0: Immediate, 1: 1 ring, 2: 2 rings, 3: 3 rings, 4: 4 rings, 5: 5 rings, 6: 6 rings, 7: No ring). In this case, you can automatically join a new ICD Group by creating a button for that group.
- \*4 This button is not available for a PS.
- \*5 0: Day/Night/Lunch/Break, 1: Day/Night/Break, 2: Day/Night/Lunch, 3: Day/Night
- \*6 Availability of this button depends on the ISDN service of your telephone company. Refer to "1.2.5 Accessing the ISDN Service (ISDN Service Access)".
- \*7 This button is not available for the KX-T7665.
- \*8 The button may not be available depending on the networking method in use or the settings of the PBX.
- \*9 This button is only available for KX-TDA100/KX-TDA200/KX-TDA600.
- \*10 It is possible to set delayed ringing for each SDN button.
- \*11 This button is used for the integrated voice mail features.
- \*12 The default voice mail floating extension number is 500.
- **To exit at any time**, lift the handset.



- You can select the parameter with the Navigator Key (Up or Down) instead of entering a number.

**To distinguish the ringing tones for each CO, INTERCOM, ICD Group, PDN, or SDN button (Digital proprietary telephone only)**

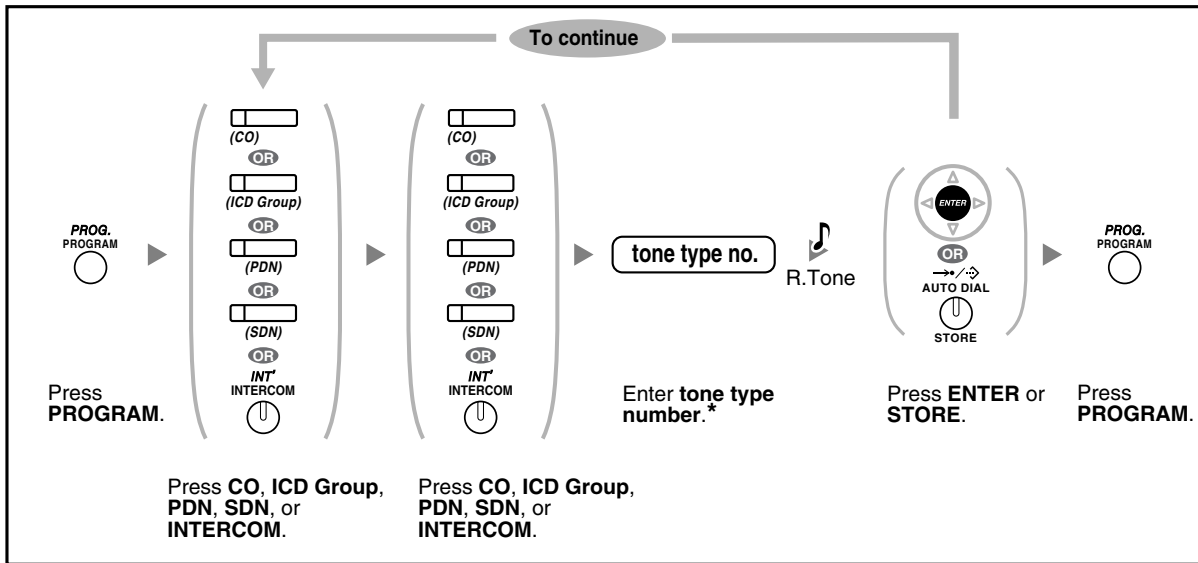

- \* Available tone types vary depending on the telephone you are using:
  - IP-PTs (except KX-NT265)/KX-T7600 series PTs (except KX-T7665): Tone types "01" to "30" (01–20: tone, 21–30: melody) are available.
  - KX-NT265/KX-T7665: Only tone types "01" to "08" are available. It is possible to enter a tone type number from "09" to "30", but you will hear tone type "01".
  - Other telephones: Only tone types "01" to "08" are available. It is possible to enter a tone type number from "09" to "30", but you will hear tone type "02".
  - Only one ringing tone can be selected for all PDN buttons on your extension.

**To clear the button**

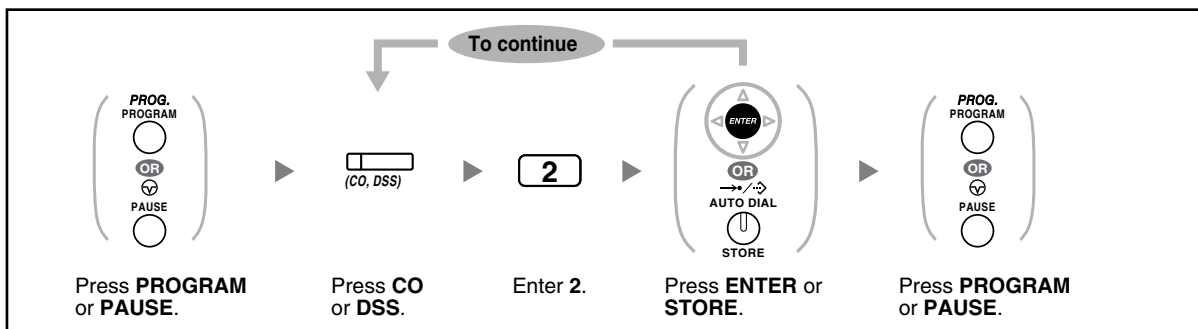

## 3.2 Manager Programming

### 3.2.1 Programming Information

The manager can programme the following items.

- Call Charges
- Other Extensions Control

#### **Available Extension**

The extension assigned as a manager

#### **Required Telephone**

A Panasonic Proprietary Telephone with display (over 2 lines)  
(e.g., KX-T7636)

#### **Manager Password**

To enter programming mode, the manager password (max. 10 digits) is required. (Default: 1234)

#### **WARNING**

- The PBX has a default password preset. For security, change the password the first time that you programme the PBX.
- It is strongly recommended that a password of 10 numbers or characters be used for maximum protection against unauthorised access. For a list of numbers and characters that can be used in the password, refer to "Entering Characters".
- To avoid unauthorised access to the PBX, keep the password secret. If it becomes known to others, the PBX may be misused.
- Change the password periodically.

#### **Conditions**

The programming extension must be idle, on-hook and holding no calls.







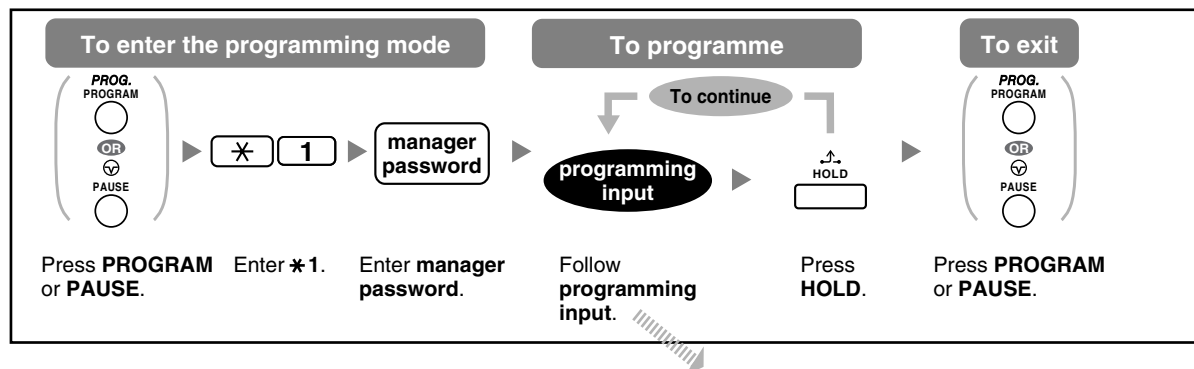



## 3.2.2 Manager Programming

### ◆◆ Changing Call Charges and Extension Control



Item	Programming Input
Changing the manager password.	<b>0 0</b> +  + Password (max. 10 digits) +
Viewing extension call charges.	<b>0 1</b> +  + Extension no.
Clearing extension call charges.	<b>0 1</b> +  + Extension no. +  +
Setting the budget for extension call charges.	<b>0 2</b> +  + Extension no. + Charge* +
Viewing call charges for each verification code.	<b>0 3</b> +  + Verification code
Clearing call charges for each verification code.	<b>0 3</b> +  + Verification code +  +
Setting the budget for each verification code.	<b>0 4</b> +  + Verification code + Charge* +
Viewing call charges for each outside line.	<b>0 5</b> +  + Outside line no. (3 digits)
Assigning a charge rate for each outside line group.	<b>0 6</b> +  + Outside line group no. (2 digits) + Charge rate* +
Clearing all charges.	<b>0 7</b> +  +
Printing the total call charge.	<b>0 8</b> +  +
Locking/unlocking other extensions. (Remote Extension Dial Lock)	<b>9 0</b> +  + Extension no. + <b>1</b> (to lock)/ <b>0</b> (to unlock) +
Clearing the PIN and PIN lock for extensions.	<b>9 1</b> +  + Extension no. +

### 3.2 Manager Programming

Item	Programming Input
Clearing the PIN and PIN lock for verification codes.	  +  + Verification code + 
Setting the verification code PIN.	  +  + Verification code + PIN (max. 10 digits) + 



- **WARNING**  
 There is a risk that fraudulent telephone calls will be made if a third party discovers your password (verification code PIN).  
 The cost of such calls will be billed to the owner/renter of the PBX.  
 To protect the PBX from this kind of fraudulent use, we strongly recommend:
  - a) Keeping your PIN secret.
  - b) Selecting a complex, random PIN that cannot be easily guessed.
  - c) Changing your PIN regularly.
- \* To enter a decimal point, press \* .

## 3.3 Customising Your System (System Programming)

### 3.3.1 Programming Information

You can customise your system according to your requirements.  
[Your system already has default settings (factory installed).]

**The programming is shown below. (Programme number)**

- The date and time [000]
- System speed dialling numbers and names [001]/[002]
- Extension number and name [003]/[004]

#### Available Extension

The extension allowed through COS programming

#### Required Telephone

A Panasonic Proprietary Telephone with display (over 2 lines)  
(e.g., KX-T7636)

#### System Password

To enter programming mode, the system password (max. 10 digits) is required. (Default: 1234)

#### **WARNING**

- The PBX has a default password preset. For security, change the password the first time that you programme the PBX.
- It is strongly recommended that a password of 10 numbers or characters be used for maximum protection against unauthorised access. For a list of numbers and characters that can be used in the password, refer to "Entering Characters".
- To avoid unauthorised access to the PBX, keep the password secret. If it becomes known to others, the PBX may be misused.
- Change the password periodically.

#### Conditions

The programming extension must be idle, on-hook and holding no calls.

#### List

Before programming, decide the settings and write them down. Your notes will provide a useful record of the programming for future reference. Your dealer also has programming records which contain all of the system programming. You may ask for photocopies of these tables to be aware of the facilities and features available.

## ◆◆ Icon Descriptions

Fixed Buttons		Function
T7600/IP-PT*1	T7200/T7400/T7500*2	
		PREVIOUS (PREV)
		NEXT
		➔
		➔
		STORE (ENTER)
	None	Back to Previous Menu (CANCEL)
		SHIFT
		PROGRAM
		END
		SELECT
		FLASH
		CLEAR
		SECRET

\*1: The buttons shown in this column are from KX-T7600 series PTs.

\*2: The buttons shown in this column are from KX-T7400 series PTs.

## ◆◆ Procedure

The basic steps are shown below.

### 1. Entering the programming mode

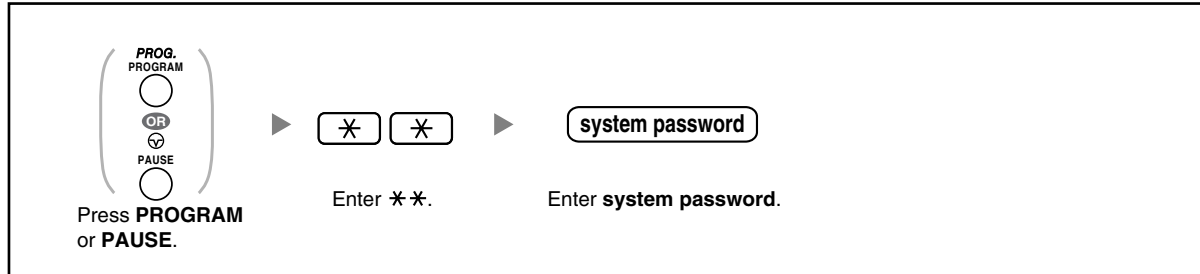

### 2. Programming

You can enter each programme number (3 digits).



- To exit the programming mode at any time, lift the handset.

### 3. Exiting the mode

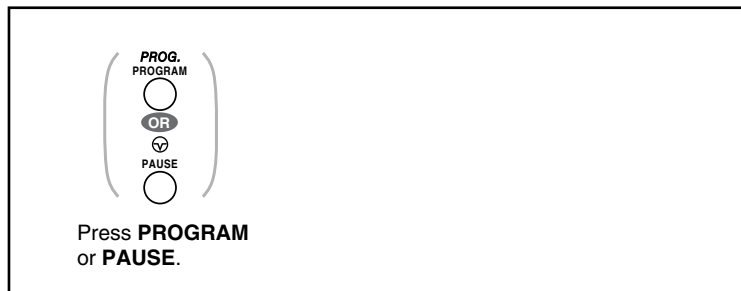

- To exit the programming mode at any time, lift the handset.

## 3.3.2 System Programming

### ◆◆ Date & Time [000]

The proprietary telephones display the current date and time while on-hook.

[In 12-hour Format]

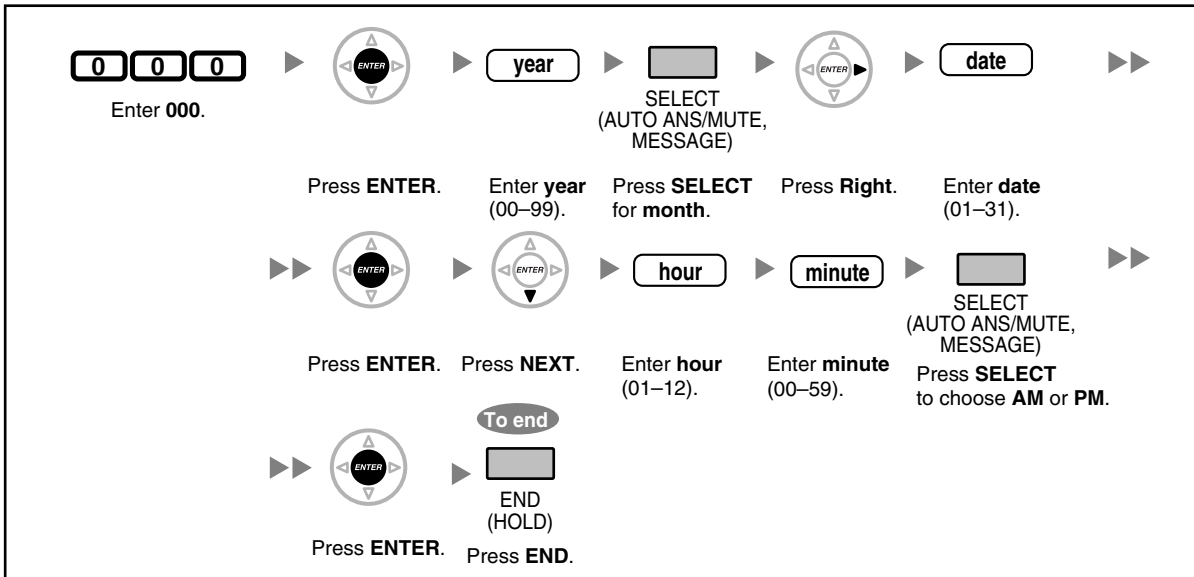

[In 24-hour Format]

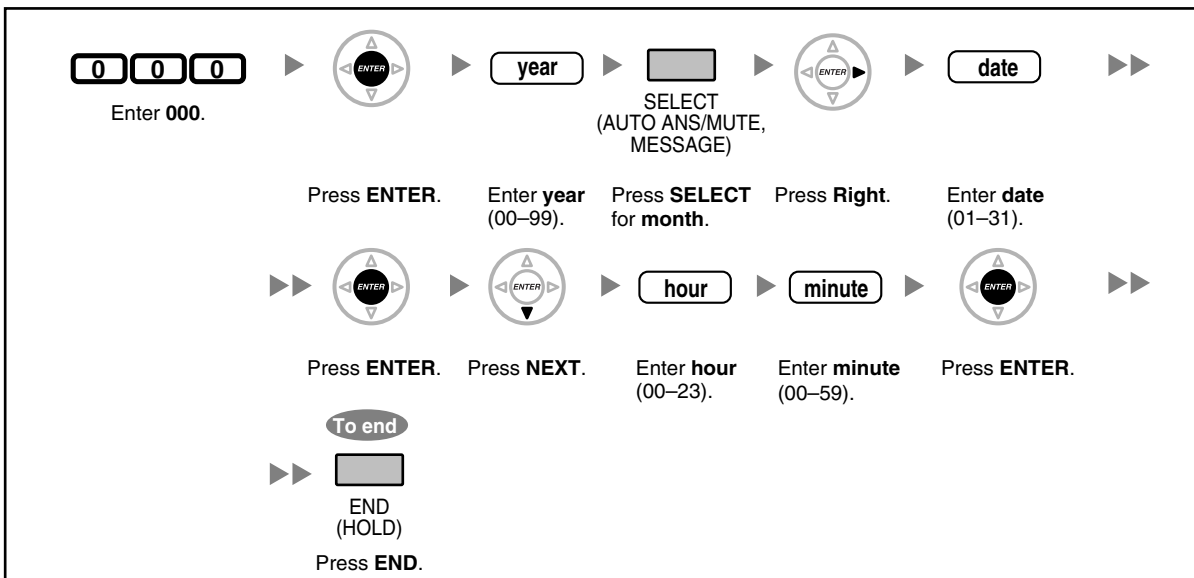



- **After changing the desired values**, you can press the ENTER button. You do not have to perform the rest of the steps.
- The clock starts immediately after the ENTER button is pressed.
- You cannot leave a value empty.
- You can clear the entry by pressing the CLEAR button.
- **To confirm your entry after storing data:**
  - The STORE button light: Lights red
  - Confirmation Tone:
    - One beep: Your entry is accepted.
    - Three beeps: Your entry is rejected.

### ◆◆ System Speed Dialling Number [001]

You can store the phone numbers of frequently dialled destinations.

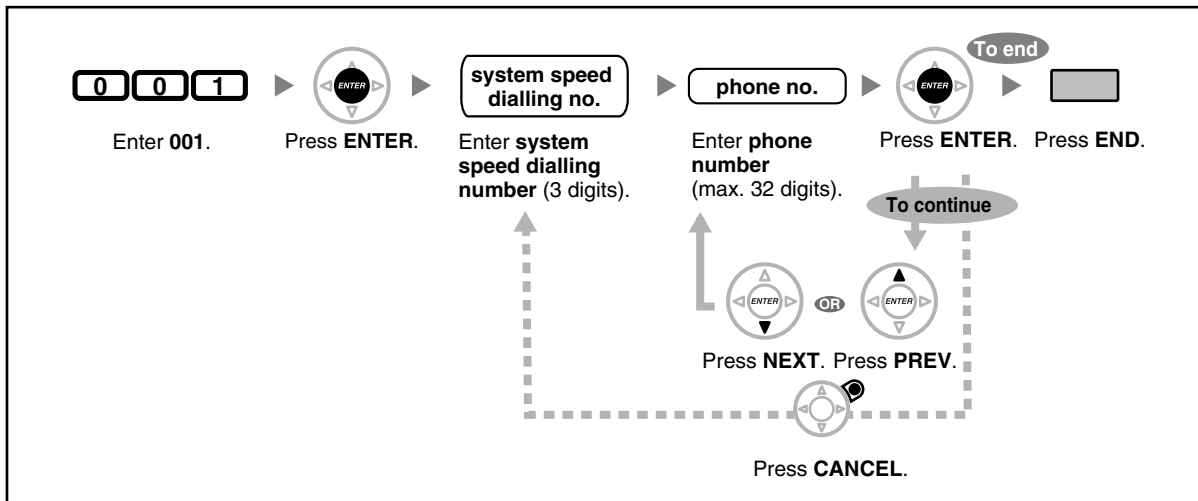

- If the desired number is more than 32 digits, divide the number and store it into more than one speed dialling number.
- "∗", "#", FLASH/RECALL, PAUSE, and Secret (INTERCOM) can also be stored. If you do not want to display the stored number when making a call, press the Secret (INTERCOM) button before and after the numbers you wish to conceal. If you store an outside party's number, you should first store a line access number. If you need to enter an account code, you can enter the specified account code before the line access number.

<Example>

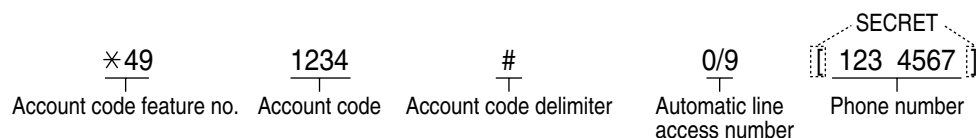

### ◆◆ System Speed Dialling Name [002]

You can store the name associated with the speed dialling number. These names are displayed when making calls using the display operation. To enter characters, refer to "Entering Characters".

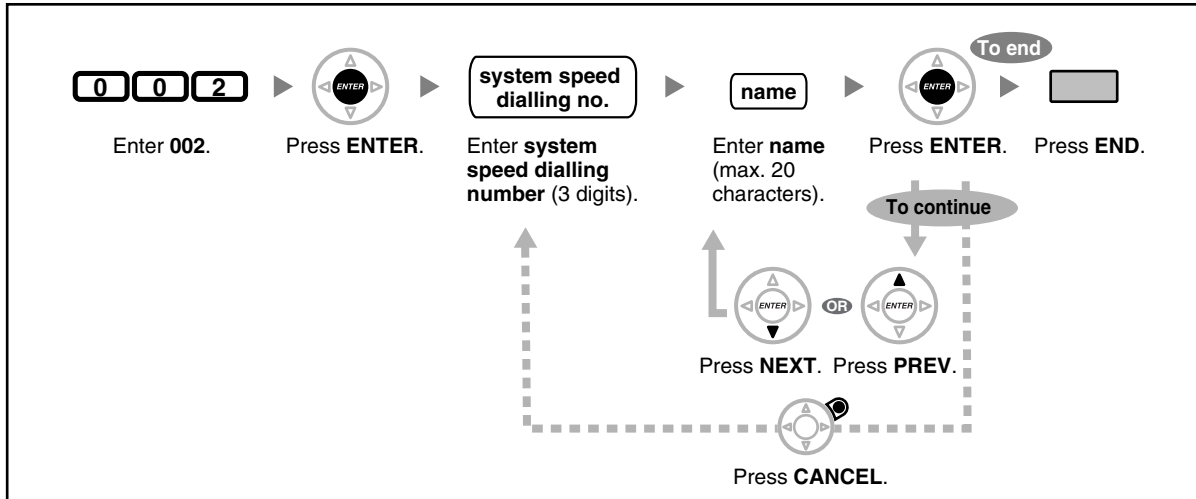

### ◆◆ Extension Number [003]

You can assign an extension number to each extension.

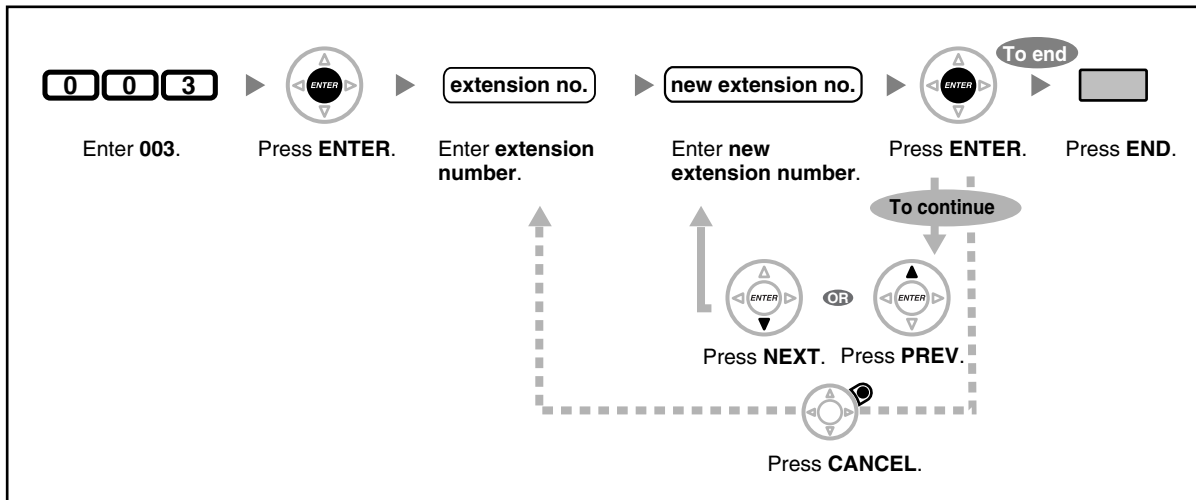

- The leading number(s) should be the same as the number(s) assigned for Flexible Numbering.
- A duplicate entry is invalid.



## ◆◆ Extension Name [004]

You can store the name of an extension user. This is useful if you want to know who is calling, or who you are calling when making an intercom call using the directory.  
To enter characters, refer to "Entering Characters".

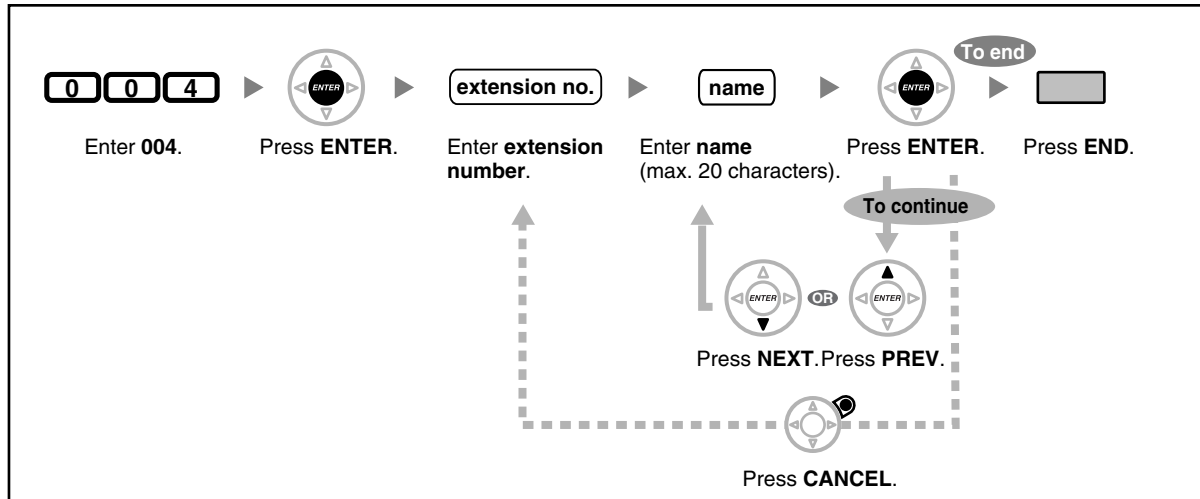

### 3.3 Customising Your System (System Programming)

---

---

## **Section 4**





### **Appendix**











*This chapter provides the Troubleshooting, the Feature Number Table and Tone List. Check the Troubleshooting section before consulting your dealer.*

## 4.1 Troubleshooting















### 4.1.1 Troubleshooting

#### ◆◆ Troubleshooting

Problem	Remedy
The telephone does not work properly.	<ul style="list-style-type: none"> <li>➤ Confirm with your manager that your settings are correct.</li> <li>➤ If the problem persists, consult your dealer.</li> </ul>
The telephone does not respond when buttons are pressed.	<ul style="list-style-type: none"> <li>• <b>The telephone is locked.</b> ➤ Unlock your telephone. (  1.6.4 Preventing Other People from Using Your Telephone (Extension Dial Lock), 2.1.1 Extension Control)</li> <li>• <b>Your telephone is connected to an eXtra Device Port.</b> ➤ System programming is required. Consult your dealer.</li> </ul>
Some features do not work.	<ul style="list-style-type: none"> <li>• <b>System management may restrict certain features.</b> ➤ Consult your manager.</li> <li>• <b>The feature numbers have changed.</b> ➤ Confirm the revised number and try again.</li> </ul>
Even though following the manual instructions, none of the operations work when using a proprietary telephone.	<ul style="list-style-type: none"> <li>• <b>The Intercom line was not seized.</b> The seized line, when going off-hook, was changed by personal setting. (  3.1.2 Settings on the Programming Mode) ➤ In the manual, going off-hook means an Intercom line is seized. If the setting has been changed, press the INTERCOM or PDN button after going off-hook and follow the instructions.</li> </ul>
The paralleled single line telephones do not ring.	<ul style="list-style-type: none"> <li>• <b>"No ring" may be selected.</b> Change the setting to ring. (  1.8.11 Setting the Paralleled Telephone to Ring (Paralleled Telephone))</li> </ul>
The telephone does not work using the personal settings or with other settings. (One-touch dialling, forwarding destination, etc.)	<ul style="list-style-type: none"> <li>• <b>The extension line has been changed.</b> The previous telephone's settings have not been cleared. ➤ Clear the settings and then programme your desired settings again. (  1.8.13 Clearing Features Set at Your Extension (Extension Feature Clear), 3.1.1 Customising Your Phone (Personal Programming), 3.1.3 Customising the Buttons)</li> </ul>

Problem	Remedy
My proprietary telephone does not have a feature button.	<ul style="list-style-type: none"> <li>• <b>Some models do not have the feature button.</b> <ul style="list-style-type: none"> <li>➤ Change a flexible button to the desired button. (  3.1.3 Customising the Buttons)</li> <li>➤ Enter the specified feature number instead of the feature button. (  1.1.1 Before Operating the Telephones)</li> </ul> </li> </ul>
A reorder tone is audible or "Restricted" is displayed.	<ul style="list-style-type: none"> <li>• <b>The telephone is locked.</b> <ul style="list-style-type: none"> <li>➤ Unlock your telephone. (  1.6.4 Preventing Other People from Using Your Telephone (Extension Dial Lock), 2.1.1 Extension Control)</li> </ul> </li> <li>• <b>Toll restriction is activated.</b> <ul style="list-style-type: none"> <li>➤ Consult your manager or dealer.</li> </ul> </li> <li>• <b>An account code is required.</b> (  1.2.7 Calling without Restrictions, Using an Account Code (Account Code Entry) in 1.2.1 Basic Calling)</li> </ul>
I cannot make an outside call using the One-touch Dialling button or speed dialling.	<ul style="list-style-type: none"> <li>• <b>A line access number was not stored.</b> <ul style="list-style-type: none"> <li>➤ A line access number is required for outside calls. (  1.2.1 Basic Calling, 3.1.3 Customising the Buttons)</li> </ul> </li> </ul>
I cannot remember the feature numbers.	<ul style="list-style-type: none"> <li>• ➤ If the feature numbers have been changed from the default values, write the new feature numbers in the table in "4.2.1 Feature Number Table".</li> <li>• ➤ Ask your dealer to change the feature numbers for easier use.</li> </ul>
While talking to an outside party, the line is disconnected.	<ul style="list-style-type: none"> <li>• <b>The time limit has run out.</b> (  1.4.1 Transferring a Call (Call Transfer), 1.4.5 Multiple Party Conversation) <ul style="list-style-type: none"> <li>➤ Consult your dealer to extend the time limit, if necessary.</li> </ul> </li> </ul>
Redialling does not function.	<ul style="list-style-type: none"> <li>• <b>The stored number was more than 32 digits or an extension number.</b> (  1.2.3 Redial)</li> </ul>
The personal computer and fax machine communication failed.	<ul style="list-style-type: none"> <li>• <b>An indication tone may have interrupted communication.</b> (  1.8.9 Protecting Your Line against Notification Tones (Data Line Security))</li> </ul>
I do not want to show my telephone number to the calling or called party's telephone.	<ul style="list-style-type: none"> <li>• (  1.8.5 Preventing Your Telephone Number Being Displayed on the Caller's Telephone (Connected Line Identification Restriction [COLR]), 1.8.6 Preventing Your Number Being Displayed on the Called Party's Telephone (Calling Line Identification Restriction [CLIR]))</li> </ul>
I want to show my telephone number to the calling or called party's telephone.	<ul style="list-style-type: none"> <li>• (  1.8.4 Displaying Your Telephone Number on the Called Party and Caller's Telephone (Calling/ Connected Line Identification Presentation [CLIP/ COLP]))</li> </ul>

## 4.1 Troubleshooting

Problem	Remedy
<p><b>I cannot send a call waiting tone to the dialled extension.</b></p>	<ul style="list-style-type: none"> <li>• <b>The other party has not set the Call Waiting feature.</b> (  Sending a Call Waiting Notification (Call Waiting), 1.4.4 Answering Call Waiting, 1.8.3 Receiving Call Waiting (Call Waiting/Off-hook Call Announcement [OHCA]/Whisper OHCA))</li> <li>• <b>The other party has set Data Line Security.</b> (  1.8.9 Protecting Your Line against Notification Tones (Data Line Security))</li> </ul>
<p><b>I forgot the password.</b></p>	<ul style="list-style-type: none"> <li>• Ask the manager to assist you. (  2.1.1 Extension Control)</li> </ul>
<p><b>The background music started suddenly.</b></p>	<ul style="list-style-type: none"> <li>•  Turn off the music. (  1.8.8 Turning on the Background Music (BGM), 2.1.4 Turning on the External Background Music (BGM))</li> </ul>
<p><b>I do not want to display a number which is stored in memory.</b></p>	<ul style="list-style-type: none"> <li>•  Conceal the number. (  Storing Names and Numbers, 3.1.3 Customising the Buttons)</li> </ul>
<p><b>I want to confirm my extension number.</b></p>	<ul style="list-style-type: none"> <li>• (  Your Extension Number in 1.1.1 Before Operating the Telephones)</li> </ul>
<p><b>The date and time are not correct.</b></p>	<ul style="list-style-type: none"> <li>• <b>Set the date and time by system programming.</b> (  Date &amp; Time [000] in 3.3.2 System Programming)</li> </ul>
<p><b>The display is not shown well.</b></p>	<ul style="list-style-type: none"> <li>•  Change the Display contrast level. (  3.1.2 Settings on the Programming Mode)</li> </ul>
<p><b>I want to distinguish the tones.</b></p>	<ul style="list-style-type: none"> <li>• (  To distinguish the ringing tones for each CO, INTERCOM, ICD Group, PDN, or SDN button (Digital proprietary telephone only), 3.1.3 Customising the Buttons)</li> </ul>
<p><b>The MESSAGE button light lit.</b></p>	<ul style="list-style-type: none"> <li>• <b>Another extension left you a message waiting indication while you were on the phone or away from your desk.</b></li> </ul>
<p><b>An SDN button on my extension does not work.</b></p>	<ul style="list-style-type: none"> <li>• <b>A PDN button is not assigned on the extension corresponding to your SDN button.</b>  Create a PDN button on the desired extension. (  3.1.3 Customising the Buttons)</li> </ul>

## 4.2 Feature Number Table

### 4.2.1 Feature Number Table

Numbers listed below are the default settings. There are flexible feature numbers and fixed feature numbers. If you change the flexible feature numbers, fill in your assigned numbers (new) in the list for future reference.

Feature (While dial tone is heard)	Default (New)	Additional digits/buttons
<b>1.2.1 Basic Calling</b> To call an operator (Operator Call)	9/0 (      )	
To select an idle outside line automatically (Automatic Line Access)	0/9 (      )	outside phone no.
To select an idle outside line in the specified outside line group automatically (Outside Line Group Access)	8 (      )	outside line group no. (2 digits) + outside phone no.
Making a Call to a Private Network (TIE Line Access)	7 (      )	private phone no.
Using an Account Code (Account Code Entry)	*49 (      )	account code + # + outside phone no.
<b>1.2.2 Easy Dialling</b> Using Numbers Stored at Your Extension (Personal Speed Dialling)		
– To store	*30 (      )	personal speed dialling no. (2 digits) + phone no. + #
– To dial	* (      )	* + personal speed dialling no. (2 digits)
Using Numbers Stored in the PBX (System Speed Dialling)		
– To dial	* (      )	system speed dialling no. (3 digits)
To a Preset Number by Going Off-hook (Hot Line)	*740 (      )	
– To store		2 + phone no. + #
– To set		1
– To cancel		0
<b>1.2.3 Redial</b> Redialling the Last Number You Dialed (Last Number Redial)	# (      )	

## 4.2 Feature Number Table

Feature (While dial tone is heard)	Default (New)	Additional digits/buttons
<p>1.2.4 When the Dialed Line is Busy or There is No Answer</p> <p>To cancel callback ringing (Automatic Callback Busy Cancel)/To cancel (CCBS Cancel)</p> <p>Leaving a Message Waiting Indication/ Calling Back the Caller Who Left an Indication (Message Waiting)</p> <p>For a caller</p> <ul style="list-style-type: none"> <li>- To leave/cancel</li> </ul> <p>For a called extension</p> <ul style="list-style-type: none"> <li>- To call back</li> <li>- To clear</li> </ul>	<p style="text-align: center;">*46 (        )</p> <p style="text-align: center;">*70 (        )</p>	<p>1/0 + extension no.</p> <p>2</p> <p>0 + your extension no.</p>
<p>1.2.7 Calling without Restrictions</p> <p>Using Your Calling Privileges at Another Extension (Remote COS Access)</p> <p>To call with a verification code (Verification Code Entry)</p>	<p style="text-align: center;">*47 (        )</p>	<p>extension no. + extension PIN + phone no.</p> <p>* + verification code + verification code PIN + phone no.</p>
<p>1.2.8 To Access Another Party Directly from Outside (Direct Inward System Access [DISA])</p> <p>Calling through DISA</p> <ul style="list-style-type: none"> <li>- To an extension (In All Security Mode only)</li> <li>- To an outside party (In Trunk Security Mode/All Security Mode only)</li> </ul>		<p>your extension no./( * + verification code) + extension PIN/verification code PIN + extension no.</p> <p>your extension no./( * + verification code) + extension PIN/verification code PIN + outside phone no.</p>
<p>1.2.9 Setting Your Telephone from Another Extension or through DISA (Remote Setting)</p> <ul style="list-style-type: none"> <li>- From another extension</li> <li>- Through DISA</li> </ul>		<p>your extension no. + extension PIN + feature no.</p>



Feature (While dial tone is heard)	Default (New)	Additional digits/buttons
<p>1.3.3 Answering a Call Ringing at Another Telephone (Call Pickup)</p> <p>Answering a Call from Another Telephone (Call Pickup)</p> <ul style="list-style-type: none"> <li>– Group</li> <li>– Directed</li> </ul> <p>Denying Other People the Possibility of Picking Up Your Calls (Call Pickup Deny)</p> <ul style="list-style-type: none"> <li>– To deny</li> <li>– To allow</li> </ul>	<p>※40 ( )</p> <p>※41 ( )</p> <p>※720 ( )</p>	<p>group no. (2 digits)</p> <p>extension no.</p> <p>1</p> <p>0</p>
<p>1.3.4 Answering a Call via an External Speaker (Trunk Answer From Any Station [TAFAS])</p> <ul style="list-style-type: none"> <li>– Calls through an external speaker</li> </ul>	<p>※42 ( )</p>	<p>KX-TDA100/KX-TDA200/KX-TDA600: speaker no. (1 digit)</p> <p>KX-TDA30: 1</p>
<p>1.3.6 Identifying Malicious Calling Parties (Malicious Call Identification [MCID])</p>	<p>※7※3 ( )</p>	
<p>1.4.1 Transferring a Call (Call Transfer)</p> <p>Transferring a Call Using the ISDN Service (Call Transfer [CT]—by ISDN)</p>	<p>※62 ( )</p>	<p>phone no.</p>
<p>1.4.2 Holding a Call</p> <p>To hold (Call Hold)/To retrieve a call (Call Hold Retrieve)</p> <p>To retrieve a call (Call Hold Retrieve)</p> <ul style="list-style-type: none"> <li>– Specified with a held line number</li> <li>– Specified with a holding extension number</li> </ul> <p>Holding in a System Parking Zone (Call Park)</p> <ul style="list-style-type: none"> <li>– To set</li> <li>– To retrieve</li> </ul>	<p>※50 ( )</p> <p>※53 ( )</p> <p>※51 ( )</p> <p>※52 ( )</p>	<p>outside line no. which is held (3 digits)</p> <p>extension no. which has a held call</p> <p>parking zone no. (2 digits)/※</p> <p>stored parking zone no. (2 digits)</p>

## 4.2 Feature Number Table

Feature (While dial tone is heard)	Default (New)	Additional digits/buttons
1.4.4 Answering Call Waiting Answering Call Waiting in the PBX	×50 (        )	
Answering Call Waiting from the Telephone Company	×60 (        )	
1.4.5 Multiple Party Conversation Adding a Third Party during a Conversation Using the ISDN Service (Three-party Conference [3PTY]—by ISDN)	×62 (        )	phone no. + TRANSFER button + 3
1.6.1 Forwarding Calls Forwarding Your Calls (Call Forwarding [FWD])/ 1.8.2 Refusing Incoming Calls (Do Not Disturb [DND])		
– Both Calls	×710 (        )	0 (Cancel)/
– Outside Calls	×711 (        )	1 (Do Not Disturb [DND])/
– Intercom Calls	×712 (        )	2 (All calls) + phone no. + #/ 3 (Busy) + phone no. + #/ 4 (No Answer) + phone no. + #/ 5 (Busy/No Answer) + phone no. + #/ 7 (Follow Me) + your extension no./ 8 (Follow Me Cancel) + your extension no.
– To set the timer for "No Answer" and "Busy/No Answer"	×713 (        )	00–99 (second)
To set/cancel (Call Forwarding [FWD] for your Incoming Call Distribution Group)		
– Both Calls	×714 (        )	1 (Set) + ICD Group extension no. + phone no. + #/0 (Cancel) + ICD Group extension no.
– Outside Calls	×715 (        )	
– Intercom Calls	×716 (        )	

Feature (While dial tone is heard)	Default (New)	Additional digits/buttons
Forwarding Your Calls Using ISDN Service (Call Forwarding [CF]—by ISDN) <ul style="list-style-type: none"> <li>– To set</li> <li>– To cancel</li> <li>– To confirm</li> </ul>	*7*5 (        )	outside line no. + # + multiple subscriber no. + # + 2 (Unconditional)/3 (Busy)/4 (No Reply) + phone no. + # outside line no. + # + multiple subscriber no. + # + 0 outside line no. + # + multiple subscriber no. + # + 1
1.6.2 Using Voice Messaging (Built-in Simplified Voice Message [SVM]) (KX-TDA30 only) <p>Recording a Normal Greeting Message</p> <ul style="list-style-type: none"> <li>– To record</li> <li>– To play back</li> <li>– To clear</li> </ul> <p>Recording a Greeting Message for Each Time Mode</p> <ul style="list-style-type: none"> <li>– To record</li> <li>– To play back</li> <li>– To clear</li> </ul> <p>To leave a voice message directly to another extension's message box</p> <p>Listening to Voice Messages Left by Callers</p> <p>Redirecting Your Calls to Your Message Box</p> <ul style="list-style-type: none"> <li>– Both Calls</li> <li>– Outside Calls</li> <li>– Intercom Calls</li> </ul>	*38 (        )	1 2 0 8 + 0 (Day)/1 (Night)/2 (Lunch)/3 (Break) + 1 8 + 0 (Day)/1 (Night)/2 (Lunch)/3 (Break) + 2 8 + 0 (Day)/1 (Night)/2 (Lunch)/3 (Break) + 0 # + 6 + extension no. 3 0 (Cancel)/ 2 (All Calls) + floating extension no. for SVM card*5 + #/ 3 (Busy) + floating extension no. for SVM card*5 + #/ 4 (No Answer) + floating extension no. for SVM card*5 + #/ 5 (Busy/No Answer) + floating extension no. for SVM card*5 + #

## 4.2 Feature Number Table

Feature (While dial tone is heard)	Default (New)	Additional digits/buttons
1.6.3 Showing a Message on the Caller's Telephone Display (Absent Message) <ul style="list-style-type: none"> <li>– To set</li> <li>– To cancel</li> </ul>	*750 (        )	1–9 (+ parameter) + # 0
1.6.4 Preventing Other People from Using Your Telephone (Extension Dial Lock) <ul style="list-style-type: none"> <li>– To lock</li> <li>– To unlock</li> <li>– To make an outside call while your extension is locked</li> </ul>	*77 (        )	1 0 + extension PIN your extension no. + extension PIN + phone no.
1.7.1 Paging Group Paging	*33 (        )	paging group no. (2 digits)
1.7.2 Answering/Denying a Paging Announcement <ul style="list-style-type: none"> <li>– To answer</li> <li>– To deny</li> <li>– To allow</li> </ul>	*43 (        ) *721 (        )	1 0
1.7.3 Making an Announcement and Having a Multiple Party Conversation (Broadcasting) <ul style="list-style-type: none"> <li>– To call and make an announcement</li> </ul>	*32 (        )	broadcasting group no. (1 digit)
1.8.1 Setting the Alarm (Timed Reminder) <ul style="list-style-type: none"> <li>– To set</li> <li>– To cancel</li> </ul>	*760 (        )	12H: 1 + hour/minute + 0 (AM)/1 (PM) + 0 (once)/1 (daily) 24H: 1 + hour/minute + 0 (once)/1 (daily) 0
1.8.3 Receiving Call Waiting (Call Waiting/Off-hook Call Announcement [OHCA]/Whisper OHCA) <ul style="list-style-type: none"> <li>– For intercom calls (No call/Tone/OHCA/Whisper OHCA)</li> <li>– For outside calls (No tone/Tone)</li> </ul>	*731 (        ) *732 (        )	0 (No call)/1 (Tone)/2 (OHCA)/3 (Whisper OHCA) 0 (No tone)/1 (Tone)

Feature (While dial tone is heard)	Default (New)	Additional digits/buttons
1.8.4 Displaying Your Telephone Number on the Called Party and Caller's Telephone (Calling/Connected Line Identification Presentation [CLIP/COLP]) <ul style="list-style-type: none"> <li>- Public</li> <li>- Your extension</li> </ul>	*7*2 (        )	1 2
1.8.5 Preventing Your Telephone Number Being Displayed on the Caller's Telephone (Connected Line Identification Restriction [COLR]) <ul style="list-style-type: none"> <li>- To show</li> <li>- To prevent</li> </ul>	*7*0 (        )	0 1
1.8.6 Preventing Your Number Being Displayed on the Called Party's Telephone (Calling Line Identification Restriction [CLIR]) <ul style="list-style-type: none"> <li>- To show</li> <li>- To prevent</li> </ul>	*7*1 (        )	0 1
1.8.7 Preventing Other People from Joining Your Conversation (Executive Busy Override Deny) <ul style="list-style-type: none"> <li>- To prevent</li> <li>- To allow</li> </ul>	*733 (        )	1 0
1.8.8 Turning on the Background Music (BGM) <ul style="list-style-type: none"> <li>- To set</li> <li>- To cancel</li> </ul>	*751 (        )	KX-TDA100/KX-TDA200/KX-TDA600: BGM no. (1 digit) KX-TDA30: 1 0
1.8.9 Protecting Your Line against Notification Tones (Data Line Security) <ul style="list-style-type: none"> <li>- To set</li> <li>- To cancel</li> </ul>	*730 (        )	1 0
1.8.11 Setting the Paralleled Telephone to Ring (Paralleled Telephone) <ul style="list-style-type: none"> <li>- Ring</li> <li>- No Ring</li> </ul>	*39 (        )	1 0

## 4.2 Feature Number Table

Feature (While dial tone is heard)	Default (New)	Additional digits/buttons
1.8.12 Using Your PS in Parallel with a Wired Telephone (Wireless XDP Parallel Mode) <ul style="list-style-type: none"> <li>- To set</li> <li>- To cancel</li> </ul>	*48 (        )	1 + paired wired extension no. 0
1.8.13 Clearing Features Set at Your Extension (Extension Feature Clear)	*790 (        )	
1.9.1 Leaving an Incoming Call Distribution Group (Log-in/Log-out, Wrap-up) <ul style="list-style-type: none"> <li>Log-in</li> <li>Log-out</li> <li>To enter/leave Not Ready mode</li> </ul>	*736 (        )	1 + ICD Group extension no./* 0 + ICD Group extension no./* 1 (Not Ready)/0 (Ready)
*3 1.9.2 Monitoring and Controlling the Call Status of an Incoming Call Distribution Group (Incoming Call Distribution Group Monitor)	*739 (        )	ICD Group extension no.
1.10.1 If a Doorphone/Door Opener is Connected <ul style="list-style-type: none"> <li>Doorphone Call</li> <li>Opening a Door (Door Open)</li> </ul>	*31 (        )	doorphone no. (2 digits)
	*55 (        )	doorphone no. (2 digits)
1.10.2 If an External Relay is Connected	*56 (        )	relay no. (2 digits)
1.10.4 If a Host PBX is Connected <ul style="list-style-type: none"> <li>Accessing External Services (External Feature Access [EFA])</li> </ul>	*60 (        )	service code

Feature (While dial tone is heard)	Default (New)	Additional digits/buttons
1.10.5 If a Voice Processing System is Connected Call Forwarding to Voice Mail (Voice Mail Integration) <ul style="list-style-type: none"> <li>– Both Calls</li> <li>– Outside Calls</li> <li>– Intercom Calls</li> </ul>	*710 (        )  *711 (        )  *712 (        )	0 (Cancel)/  2 (All Calls)/  3 (Busy)/ 4 (No Answer)/ 5 (Busy/No Answer) + voice mail floating extension no.*6 + #
1.11.1 Using the Telephones in a Hotel-type Environment (Hospitality Features) *4 Setting a Timed Reminder to a Room Extension (Remote Wake-up Call) <ul style="list-style-type: none"> <li>– To set</li> <li>– To cancel</li> <li>– To confirm</li> </ul>	*76* (        )	12H: 1 + extension no. + hour/minute + 0 (AM)/ 1 (PM) + 0 (once)/1 (daily) 24H: 1 + extension no. + hour/minute + 0 (once)/1 (daily)  0 + extension no. 2 + extension no.
1.11.2 Recording Information Using Preprogrammed Messages (Printing Message)	*761 (        )	message no. (+ parameter) + #
1.12.1 Using the Same Settings as Your Previous Extension (Walking Extension)	*727 (        )	your previous extension no. + extension PIN
2.1.1 Extension Control *1 To lock/unlock other extensions (Remote Extension Dial Lock) <ul style="list-style-type: none"> <li>– To unlock</li> <li>– To lock</li> </ul>	*782 (        )  *783 (        )	extension no.  extension no.
*2 2.1.2 Time Service Mode Control – Day/Night/Lunch/Break	*780 (        )	0/1/2/3

## 4.2 Feature Number Table

Feature (While dial tone is heard)	Default (New)	Additional digits/buttons
<p>*1 2.1.4 Turning on the External Background Music (BGM)</p> <ul style="list-style-type: none"> <li>– To start</li> <li>– To stop</li> </ul>	<p>✖35 (        )</p>	<p>KX-TDA100/KX-TDA200/KX-TDA600: external pager no. (1 digit)/✖ + BGM no. (1 digit) KX-TDA30: 11</p> <p>KX-TDA100/KX-TDA200/KX-TDA600: external pager no. (1 digit)/✖ + 0 KX-TDA30: 10</p>
<p>*1 2.1.5 Recording Outgoing Messages (OGM)</p> <ul style="list-style-type: none"> <li>– To record</li> <li>– To play back</li> <li>– To record from an external BGM (MOH) port</li> <li>– To clear</li> </ul>	<p>✖36 (        )</p>	<p>1 + OGM floating extension no.*7 2 + OGM floating extension no.*7</p> <p>KX-TDA100/KX-TDA200/KX-TDA600: 3 + BGM port no. (1 digit) + OGM floating extension no.*7 KX-TDA30: 31 + OGM floating extension no.*7</p> <p>0 + OGM floating extension no.*7</p>
<p>*1 2.1.6 Allowing Users to Seize an Unavailable Outside Line (Trunk Busy Out)</p>	<p>✖785 (        )</p>	<p>outside line no. (3 digits)</p>
<p>*1 2.1.7 Releasing Network Direct Station Selection (NDSS) Monitor</p>	<p>✖784 (        )</p>	<p>another PBX extension no. + #</p>
<p>3.1.1 Customising Your Phone (Personal Programming)</p> <p>Assigning an Extension PIN to Your Extension (Extension PIN [Personal Identification Number])</p> <ul style="list-style-type: none"> <li>– To set</li> <li>– To cancel</li> </ul>	<p>✖799 (        )</p>	<p>1 + extension PIN + # + same extension PIN + # 0 + stored extension PIN</p>

\*1: Manager only

\*2: Manager and preprogrammed extension user only

\*3: Supervisor only

\*4: Hotel operator only

\*5: The default floating extension numbers are 591 for SVM card 1, and 592 for SVM card 2.

\*6: The default voice mail floating extension number is 500.

\*7: The default of OGM floating extension numbers is 5xx (xx: two-digit number of message).



<b>Feature (While busy, DND or call tone is heard)</b>	<b>Default</b>
1.2.4 When the Dialed Line is Busy or There is No Answer Sending a Call Waiting Notification (Call Waiting) To an Extension Refusing the Call (DND Override)	1
Joining an Existing Call (Executive Busy Override)	3
Leaving a Message Waiting Indication/Calling Back the Caller Who Left an Indication (Message Waiting)	4
Monitoring Another Extension (Call Monitor)	5
Reserving a Busy Line (Automatic Callback Busy)/Setting Callback on an ISDN Line (Completion of Calls to Busy Subscriber [CCBS])	6
1.2.6 Alternating the Calling Method (Alternate Calling—Ring/Voice)	×

<b>Feature (While dialling or talking)</b>	<b>Fixed Number</b>
1.4.5 Multiple Party Conversation Adding Other Parties during a Conversation (Conference)	3
1.10.1 If a Doorphone/Door Opener is Connected From any extension while talking to the doorphone	5

## 4.3 What is This Tone?

### 4.3.1 What is This Tone?

#### While on-hook

##### Ring Tones

The following tones are programmable allowing recognition of call type (Outside, Intercom or Doorphone).

##### Tone 1



##### Tone 2

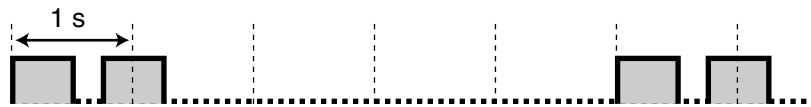

##### Tone 3



##### Tone 4

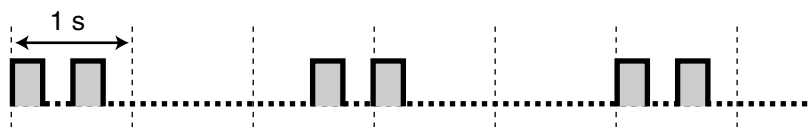

#### When going off-hook

##### Dial Tones

##### Tone 1

Normal

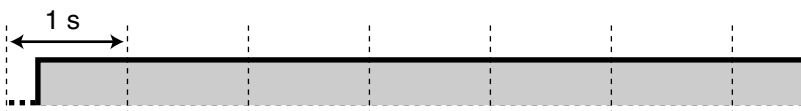

**Tone 2**

- When there are messages that have previously been listened to and no new messages on the SVM card
- When any of the following features are set:
  - Absent Message
  - Background Music
  - Call Forwarding
  - Call Pickup Deny
  - Call Waiting
  - Do Not Disturb
  - Extension Dial Lock
  - Executive Busy Override Deny
  - Hot Line
  - Timed Reminder

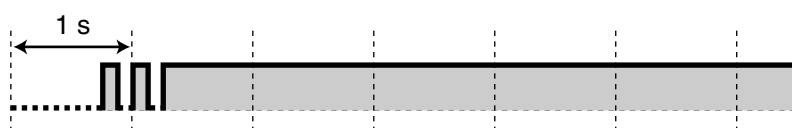
**Tone 3**

- After pressing TRANSFER or Recall/ hookswitch to hold a call temporarily (e.g., Call Splitting)
- When the recording space of the Built-in Simplified Voice Message feature becomes almost full
- While a called PS is being searched
- When Account Code Entry is performed
- When answering a Timed Reminder call with no message
- When answering an external sensor call

**Tone 4**

Message waiting indication was received.

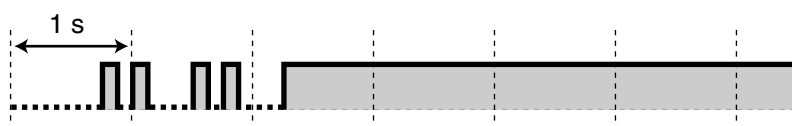
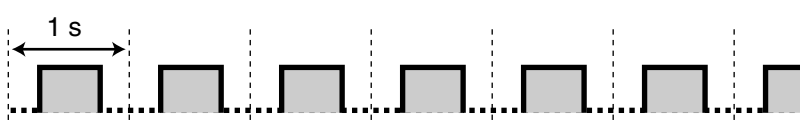
**When you make calls****Busy Tone**

### 4.3 What is This Tone?

#### Reorder Tone

The outside line you tried to seize is not assigned or denied.



#### Ringback Tones

##### Tone 1



##### Tone 2



#### Do Not Disturb (DND) Tone

The dialled extension is refusing incoming calls.

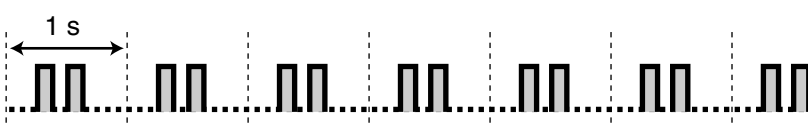

### While off-hook

#### Indication Tones

##### Tone 1

Call waiting tone

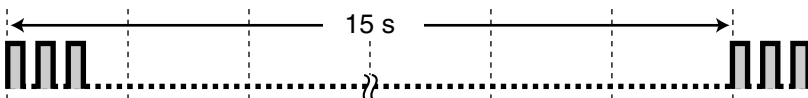

##### Tone 2

A call is on hold longer than the specified time

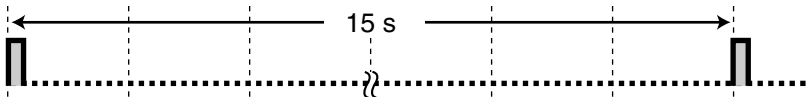

### When talking to an outside party

#### Warning Tone

This tone is sent 15, 10 and 5 seconds before the specified time for disconnection.



### When setting the features or programming

#### Confirmation Tones

##### Tone 1

The feature setting was set successfully.

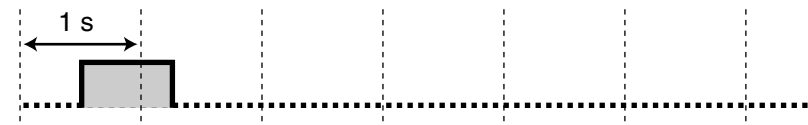

##### Tone 2

Before receiving a page through an external speaker



**Tone 3**

Before the following features activate:

- Retrieving a held call
- Picking up another call
- Paging/Answering a paging announcement
- Answering the call through a speaker

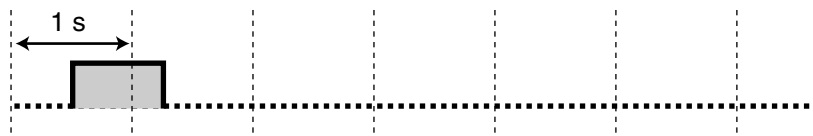
**Tone 4**

Establishing or leaving a conference

**Tone 5**

A call has been put on hold.

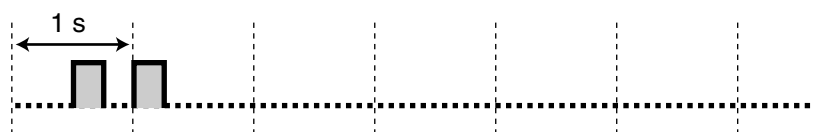

# 4.4 Revision History

## 4.4.1 KX-TDA600 PLMPR Software File Version 3.1xxx

### New Contents

- 1.5.1 Primary Directory Number (PDN)/Secondary Directory Number (SDN) Extension (KX-TDA100/KX-TDA200/KX-TDA600 only)

### Changed Contents

- 1.2.1 Basic Calling
  - To call an extension (Intercom Call)
- 1.2.4 When the Dialed Line is Busy or There is No Answer
  - Sending a Call Waiting Notification (Call Waiting)
  - Joining an Existing Call (Executive Busy Override)
  - Monitoring Another Extension (Call Monitor)
- 1.3.1 Answering Calls
- 1.4.4 Answering Call Waiting
  - Answering Call Waiting in the PBX
- 1.4.5 Multiple Party Conversation
  - Adding Other Parties during a Conversation (Conference)
  - Leaving a Conference (Unattended Conference)
- 1.12.1 Using the Same Settings as Your Previous Extension (Walking Extension)
- 3.1.2 Settings on the Programming Mode
  - Preferred Line Assignment—Outgoing
  - Preferred Line Assignment—Incoming
  - Automatic Call Waiting
  - Manual Call Waiting
- 3.1.2 Settings on the Programming Mode
  - Clearing Features
- 3.1.3 Customising the Buttons
  - Primary Directory Number (PDN)
  - Secondary Directory Number (SDN)
- 3.1.3 Customising the Buttons
  - To distinguish the ringing tones for each CO, INTERCOM, ICD Group, PDN, or SDN button (Digital proprietary telephone only)

## 4.4.2 KX-TDA100/KX-TDA200 PMPR Software File Version 1.1xxx

### New Contents

- 1.4.5 Multiple Party Conversation
  - Adding a Third Party during a Conversation Using the ISDN Service (Three-party Conference [3PTY]—by ISDN)
- 1.7.3 Making an Announcement and Having a Multiple Party Conversation (Broadcasting)

### Changed Contents

- 1.1.1 Before Operating the Telephones
  - When You Use a Panasonic Proprietary Telephone
    - FLASH/RECALL
- 1.2.4 When the Dialed Line is Busy or There is No Answer
  - Leaving a Message Waiting Indication/Calling Back the Caller Who Left an Indication (Message Waiting)
    - To clear message waiting indications left on your extension
- 1.13.1 Using the Call Log
  - Calling with the Incoming Call Log
  - Calling with the Outgoing Call Log
- 1.13.2 Using the Directories
  - Calling with the Directory
  - Storing Names and Numbers
  - Entering Characters

### 4.4.3 KX-TDA100/KX-TDA200 PMPR Software File Version 2.0xxx

#### New Contents

- 1.1.1 Before Operating the Telephones
  - When You Use a Panasonic Proprietary Telephone
    - Network Direct Station Selection (NDSS)
    - CTI
    - Check-in
    - Check-out
- 1.2.1 Basic Calling
  - Making a Call to a Private Network (TIE Line Access)
    - To call with one touch
- 1.10.2 If an External Relay is Connected
- 1.10.3 If an External Sensor is Connected
- 2.1.6 Allowing Users to Seize an Unavailable Outside Line (Trunk Busy Out)
- 1.11.1 Using the Telephones in a Hotel-type Environment (Hospitality Features)
- 2.1.7 Releasing Network Direct Station Selection (NDSS) Monitor

#### Changed Contents

- 1.2.2 Easy Dialling
  - Using Numbers Stored at Your Extension (Personal Speed Dialling)
    - To store a phone number



## 4.4.4 KX-TDA100/KX-TDA200 PMPR Software File Version 3.0xxx

### Changed Contents

- 1.2.8 To Access Another Party Directly from Outside (Direct Inward System Access [DISA])
  - To call an extension
  - To call an outside party
- 1.4.1 Transferring a Call (Call Transfer)
  - Transferring to an Extension in the PBX
    - To transfer
    - To transfer with one touch (One-touch Transfer)
- 1.6.1 Forwarding Calls
  - FWD/DND Settings Using Fixed FWD/DND Button
- 1.8.2 Refusing Incoming Calls (Do Not Disturb [DND])
  - Switching FWD/DND Status Using Fixed FWD/DND Button
- 3.1.3 Customising the Buttons
  - Incoming Call Distribution Group (ICD Group)

### 4.4.5 KX-TDA100/KX-TDA200 PMPR Software File Version 3.2xxx

#### New Contents

- 1.5.1 Primary Directory Number (PDN)/Secondary Directory Number (SDN) Extension (KX-TDA100/KX-TDA200/KX-TDA600 only)

#### Changed Contents

- 1.2.1 Basic Calling
  - To call an extension (Intercom Call)
- 1.2.4 When the Dialed Line is Busy or There is No Answer
  - Sending a Call Waiting Notification (Call Waiting)
  - Joining an Existing Call (Executive Busy Override)
  - Monitoring Another Extension (Call Monitor)
- 1.3.1 Answering Calls
- 1.4.4 Answering Call Waiting
  - Answering Call Waiting in the PBX
- 1.4.5 Multiple Party Conversation
  - Adding Other Parties during a Conversation (Conference)
  - Leaving a Conference (Unattended Conference)
- 1.12.1 Using the Same Settings as Your Previous Extension (Walking Extension)
- 1.13.1 Using the Call Log
  - Calling with the Incoming Call Log
- 3.1.2 Settings on the Programming Mode
  - Preferred Line Assignment—Outgoing
  - Preferred Line Assignment—Incoming
  - Automatic Call Waiting
  - Manual Call Waiting
- 3.1.2 Settings on the Programming Mode
  - Clearing Features
- 3.1.3 Customising the Buttons
  - Primary Directory Number (PDN)
  - Secondary Directory Number (SDN)
- 3.1.3 Customising the Buttons
  - To distinguish the ringing tones for each CO, INTERCOM, ICD Group, PDN, or SDN button (Digital proprietary telephone only)

## 4.4.6 KX-TDA30 PSMR Software File Version 1.1xxx

### New Contents

- 1.4.5 Multiple Party Conversation
  - Adding a Third Party during a Conversation Using the ISDN Service (Three-party Conference [3PTY]—by ISDN)
- 1.7.3 Making an Announcement and Having a Multiple Party Conversation (Broadcasting)

### Changed Contents

- 1.13.1 Using the Call Log
  - Calling with the Incoming Call Log
  - Calling with the Outgoing Call Log
- 1.13.2 Using the Directories
  - Calling with the Directory
  - Storing Names and Numbers
  - Entering Characters

### 4.4.7 KX-TDA30 PSMR Software File Version 2.0xxx

#### New Contents

- 1.1.1 Before Operating the Telephones
  - When You Use a Panasonic Proprietary Telephone
    - Network Direct Station Selection (NDSS)
    - CTI
    - Check-in
    - Check-out
- 1.2.1 Basic Calling
  - Making a Call to a Private Network (TIE Line Access)
    - To call with one touch
- 1.10.2 If an External Relay is Connected
- 1.10.3 If an External Sensor is Connected
- 2.1.6 Allowing Users to Seize an Unavailable Outside Line (Trunk Busy Out)
- 1.11.1 Using the Telephones in a Hotel-type Environment (Hospitality Features)
- 2.1.7 Releasing Network Direct Station Selection (NDSS) Monitor

#### Changed Contents

- 1.2.2 Easy Dialling
  - Using Numbers Stored at Your Extension (Personal Speed Dialling)
    - To store a phone number

## 4.4.8 KX-TDA30 PSMR Software File Version 2.2xxx

### New Contents

- 1.1.1 Before Operating the Telephones
  - When You Use a Panasonic Proprietary Telephone
    - Network Direct Station Selection (NDSS)
    - CTI
    - Check-in
    - Check-out
- 1.2.1 Basic Calling
  - Making a Call to a Private Network (TIE Line Access)
    - To call with one touch
- 1.6.2 Using Voice Messaging (Built-in Simplified Voice Message [SVM]) (KX-TDA30 only)
- 1.10.2 If an External Relay is Connected
- 1.10.3 If an External Sensor is Connected
- 2.1.6 Allowing Users to Seize an Unavailable Outside Line (Trunk Busy Out)
- 1.11.1 Using the Telephones in a Hotel-type Environment (Hospitality Features)
- 2.1.7 Releasing Network Direct Station Selection (NDSS) Monitor

### Changed Contents

- 1.2.2 Easy Dialling
  - Using Numbers Stored at Your Extension (Personal Speed Dialling)
    - To store a phone number
- 4.3.1 What is This Tone?

### 4.4.9 KX-TDA30 PSMR Software File Version 3.0xxx

#### Changed Contents

- 1.2.8 To Access Another Party Directly from Outside (Direct Inward System Access [DISA])
  - To call an extension
  - To call an outside party
- 1.4.1 Transferring a Call (Call Transfer)
  - Transferring to an Extension in the PBX
    - To transfer
    - To transfer with one touch (One-touch Transfer)
- 1.6.1 Forwarding Calls
  - FWD/DND Settings Using Fixed FWD/DND Button
- 1.8.2 Refusing Incoming Calls (Do Not Disturb [DND])
  - Switching FWD/DND Status Using Fixed FWD/DND Button
- 3.1.3 Customising the Buttons
  - Incoming Call Distribution Group (ICD Group)

## 4.4.10 KX-TDA30 PSMPR Software File Version 4.0xxx

### Changed Contents

- 1.2.4 When the Dialed Line is Busy or There is No Answer
  - Sending a Call Waiting Notification (Call Waiting)
- 1.12.1 Using the Same Settings as Your Previous Extension (Walking Extension)
- 1.13.1 Using the Call Log
  - Calling with the Incoming Call Log
- 3.1.2 Settings on the Programming Mode
  - Automatic Call Waiting
  - Manual Call Waiting

#### 4.4 Revision History

---



---

# ***Index***

## Index

---

- A**
- Absent Message 108, 192, 224
  - Accessing System Features (System Feature Access) 172
  - Accessing the ISDN Service (ISDN Service Access) 43
  - Account Button 21, 200
  - Account Code Entry 28, 219
  - Adding Other Parties during a Conversation (Conference) 71
  - Alarm Setting 118
  - Alarm Setting, Remote 156
  - Alternate Calling—Ring/Voice 44, 229
  - Alternate Receiving—Ring/Voice 190
  - Announcement, Making 115
  - Announcement, Making/Answering 112
  - Answer Button 19, 22, 54, 201
  - Answering Calls 50
  - Answering Calls, Hands-free 51
  - Answering Calls, Malicious 56
  - Answering Calls, Ringing at Other Telephones 52
  - Answering Calls, Via External Speaker 53
  - AUTO ANS (Auto Answer)/MUTE Button 18
  - AUTO DIAL/STORE Button 17
  - Automatic Call Hold 63, 86
  - Automatic Call Waiting 191
  - Automatic Callback Busy 35, 229
  - Automatic Callback Busy Cancel 36, 220
  - Automatic Line Access 26, 219
  - Automatic Redial 34
- B**
- Background Music (BGM) 128, 193, 225
  - Background Music, External Speaker Settings 178
  - Backlight, Display 189
  - Before Operating the Telephones 14
  - BGM → Background Music 128
  - Boss & Secretary feature 88
  - Broadcasting 115, 224
  - Built-in Simplified Voice Message 97, 223
  - Busy Station Signalling (BSS) → Call Waiting 37
  - Busy Tone 231
  - Buttons, Customising 20, 199
  - Buttons, Fixed 17
  - Buttons, Proprietary Telephone 17
- C**
- Call Charge Reference 27
  - Call Charge Reference Button 21, 200
  - Call Forwarding (CF)—by ISDN 95, 223
  - Call Forwarding (FWD) 88
  - Call Forwarding (FWD) Button 19
  - Call Forwarding (FWD)/Do Not Disturb (DND)—Both calls Button 21, 199
  - Call Hold 61, 221
  - Call Hold Retrieve 62, 221
  - Call Hold Retrieve, PDN/SDN Button 86
  - Call Log Button 21, 200
  - Call Log for ICD Group Button 21, 200
  - Call Monitor 42, 229
  - Call Park 63, 221
  - Call Park (Automatic Park Zone) Button 21, 200
  - Call Park Button 21, 200
  - Call Park Retrieve 64
  - Call Pickup 52
  - Call Pickup Deny 52, 221
  - Call Splitting 65
  - Call Transfer 57, 221
  - Call Transfer (CT)—by ISDN 59, 221
  - Call Waiting 37
  - Call Waiting Tone 123
  - Call Waiting Tone Type Selection 191
  - Call Waiting, Answering 67, 222
  - Call Waiting, Automatic 191
  - Call Waiting, From PBX 67, 222
  - Call Waiting, From Telephone Company 70, 222
  - Call Waiting, Manual 191
  - Call Waiting, Receiving 123, 224
  - Call Waiting, Sending 37
  - Call, To PDN Extension 85
  - Callback Setting 35
  - Callback Setting, ISDN Line 36
  - Calling Line Identification Presentation (CLIP) 124, 190, 225
  - Calling Line Identification Restriction (CLIR) 126, 189, 225
  - Calling Line Identification Restriction (CLIR) Button 22, 201
  - Calling, Account Code 28
  - Calling, Adding Another Party 77
  - Calling, Automatically 32
  - Calling, Directory 164
  - Calling, Extension in DND Mode 42
  - Calling, From Other Extension 45
  - Calling, From Outside Directly 46, 220
  - Calling, Incoming Call Log 160
  - Calling, Joining a Call 40
  - Calling, Last Dialed Number 34
  - Calling, One-touch Button 30
  - Calling, Operator 26
  - Calling, Other Extension 25
  - Calling, Outgoing Call Log 162
  - Calling, Outside Party 26
  - Calling, Personal Preprogrammed Numbers 30
  - Calling, Preprogrammed Numbers 33
  - Calling, Private Network 27
  - Calling, Privately 127
  - Calling, System Preprogrammed Numbers 31
  - Calling, Through DISA 46
  - Calling, Using the Headset 82
  - Calling/Connected Line Identification Presentation (CLIP/COLP) 124, 190, 225
  - CANCEL Button 20
  - CCBS Cancel 37, 220
  - CCBS → Completion of Calls to Busy Subscriber 36
  - Changing the Settings of Other Extensions 174
  - Characters, Entering 166
  - Charges, Changing 205
  - Check-in 152
  - Check-in Button 22, 201
  - Check-out 153
  - Check-out Button 22, 201
  - Clearing Settings 133, 197
  - CLIP → Calling Line Identification Presentation 124
  - CLIR → Calling Line Identification Restriction 126

CO Button 17  
 COLP → Connected Line Identification Presentation 124  
 COLR → Connected Line Identification Restriction 125  
 Completion of Calls to Busy Subscriber (CCBS) 36, 229  
 CONF (Conference) Button 19  
 Conference 71  
 Conference (ISDN Service), Adding Parties 77  
 Conference (Multiple Party), Leaving 75  
 Conference (Three-Party), Leaving 76  
 Conference Button 21, 200  
 Conference, Adding Parties 71  
 Confirmation Tones 232  
 Connected Line Identification Presentation (COLP) 124, 190, 225  
 Connected Line Identification Restriction (COLR) 125, 225  
 Connected Line Identification Restriction (COLR) Button 22, 201  
 Connection Example 24  
 Contrast Selection, Display 189  
 CTI Button 22, 201  
 Customised Buttons 20  
 Customising Your Phone (Personal Programming) 186  
 Customising Your System (System Programming) 207

## D

Data Line Security 129, 225  
 Date & Time [000] 210  
 Denying Call Pickup 52  
 Denying Other People the Possibility of Picking Up Your Calls (Call Pickup Deny) 52  
 Dial Tone Transfer 177  
 Dial Tones 230  
 Direct Inward System Access (DISA) 46, 220  
 Direct Station Selection (DSS) Button 21, 199  
 DISA → Direct Inward System Access 46  
 Display 15  
 Display Backlight Selection 189  
 Display Contrast Selection 189  
 Display Language Selection 189  
 Display Lock 193  
 Display Switching Mode 189  
 DND Override 42, 229  
 DND → Do Not Disturb 120  
 Do Not Disturb (DND) 120  
 Do Not Disturb (DND) Button 19  
 Do Not Disturb (DND) Tone 232  
 Door Open 142, 226  
 Doorphone Call 141, 226  
 DSS → Direct Station Selection 21

## E

EFA → External Feature Access 145  
 Electronic Station Lockout → Extension Dial Lock 110, 193, 224  
 Enhanced DSS Key Mode 85  
 ENTER Button 20  
 Entering Characters 166  
 Exclusive Call Hold 61  
 Executive Busy Override 40, 229  
 Executive Busy Override Deny 127, 192, 225  
 Extension Control 174, 205  
 Extension Dial Lock 110, 193, 224

Extension Feature Clear 133, 226  
 Extension Name [004] 213  
 Extension Number [003] 212  
 Extension number, Confirming Your Own 15  
 Extension PIN (Personal Identification Number) 186, 193, 228  
 External Background Music (BGM) 178, 228  
 External Feature Access (EFA) 145, 200, 226  
 External Feature Access (EFA) Button 21, 200  
 External Relay 143  
 External Sensor 144

## F

Feature Highlights 2  
 Feature Number Table 219  
 Feature Numbers 14  
 Fixed Buttons 17  
 FLASH/RECALL Button 19  
 Forced Answerback Selection 191  
 Forwarding Calls 88  
 Forwarding Calls, ISDN Service 95  
 Forwarding Calls, To Incoming Call Distribution Group 90, 222  
 FWD N/A Timer 192  
 FWD/DND Cycle Switch Mode 91, 121  
 FWD/DND Setting Mode 91, 121  
 FWD/DND settings, FWD/DND fixed button 92  
 FWD/DND status, switching with FWD/DND fixed button 92, 121  
 FWD/DND—Intercom calls Button 21, 200  
 FWD/DND—Outside calls Button 21, 199

## G

G-CO → Group-CO 20  
 Greeting Message, Recording 98, 99  
 Group FWD—Both calls Button 21, 200  
 Group FWD—Intercom calls Button 21, 200  
 Group FWD—Outside calls Button 21, 200  
 Group Paging 224  
 Group-CO (G-CO) Button 20, 199

## H

Handset/Headset Selection → Headset Operation 82, 192  
 Hands-free Answerback 51  
 Hands-free operation 81  
 Headset Button 22, 201  
 Headset Operation 82, 192  
 HOLD Button 18  
 Holding Calls 61  
 Holding in a System Parking Zone (Call Park) 63  
 Hospitality Features 152  
 Host PBX 145  
 Hot Line 32, 219  
 Hotel Use 152  
 Hurry-up Button 21, 200  
 Hurry-up Transfer → Manual Queue Redirection 140

## I

ICD Group → Incoming Call Distribution Group 21  
 Icon Descriptions 16, 208  
 Incoming Call Distribution Group (ICD Group) 21, 199

## Index

---

Incoming Call Distribution Group Monitor 137, 226  
Incoming Call Distribution Group, Extension Status 138  
Incoming Call Distribution Group, Forwarding Calls 140  
Incoming Call Distribution Group, Leaving 134  
Incoming Call Distribution Group, Monitoring and Controlling 137  
Incoming Call Distribution Group, Waiting Call Status 137  
Incoming Call Log 160  
Indication Tones 232  
INTERCOM Button 18  
Intercom Call 25  
ISDN Service Access 43  
ISDN Service Button 22, 201  
ISDN-Hold Button 22, 201

## J

Jog Dial 15, 20  
Joining an Existing Call (Executive Busy Override) 40

## K

Key Pad Tone Set 193

## L

Language, Display 189  
Last Number Redial 34, 219  
L-CO → Loop-CO 20  
LCS Mode Set (After Answering) 191  
LCS → Live Call Screening 148  
Leaving a Message Waiting Indication/Calling Back the Caller Who Left an Indication (Message Waiting) 38  
Leaving Three-party Conference 76  
Live Call Screening (LCS) 148  
Live Call Screening Button 22, 201  
Live Call Screening Mode Set 191  
Locking Your Telephone 110  
Log-in/Log-out 134, 226  
Log-in/Log-out Button 21, 200  
Log-in/Log-out for all groups Button 21, 200  
Log-in/Log-out of a specified group Button 21, 200  
Loop-CO (L-CO) Button 20, 199

## M

Malicious Call Identification (MCID) 56, 221  
Manager Operation 174  
Manager Password 204  
Manager Programming Information 204  
Manual Call Waiting 191  
Manual Queue Redirection 140  
Message Box, Accessing from Outside 106  
Message Box, Accessing Other Extension's 107  
Message Box, Redirecting to 101  
Message Button 17, 21, 199  
Message Display (Absent Message) 108  
Message for Another Extension Button 21, 199  
Message Waiting 38, 220, 229  
Messages (Preprogrammed), Recording 158  
MODE Button 20  
MONITOR Button 18  
Monitoring Another Extension (Call Monitor) 42

Multiple Party Conversation 71, 115  
Mute 80

## N

Names and Numbers, Storing 165  
Navigator Key 15, 20  
NDSS → Network Direct Station Selection 183  
Network Direct Station Selection (NDSS) Button 22, 201  
Network Direct Station Selection, Releasing 183

## O

Off-hook Call Announcement (OHCA) 123, 224  
Off-hook Monitor 81  
OGM → Outgoing Messages 179  
OHCA → Off-hook Call Announcement 123  
One-touch Dialling 30  
One-touch Dialling Assignment Mode Selection 194  
One-touch Dialling Button 21, 199  
One-touch Transfer 58  
One-touch Two-way Transfer 150  
One-touch Two-way Transfer Button 22, 201  
Operating Telephones, Preparations 14  
Operator Call 26, 219  
Outgoing Call Log 162  
Outgoing Messages (OGM) 179, 228  
Outgoing Messages (OGM), Recording 179  
Outside Line Group Access 26, 219  
Outside Line, Re-enabling Unavailable 182

## P

Paging 112  
Paging Announcement, Answering/Denying 114  
Paging Deny 114, 193  
Paging, and Transferring 112  
Paging, Group 112  
Parallelled Telephone 131, 191, 225  
Parallelled Telephone Setting 131  
PAUSE Button 17  
PDN Extension 84  
PDN → Primary Directory Number 84  
Personal Absent Message 192  
Personal Programming 186  
Personal Speed Dialling 30, 219  
PF → Programmable Feature 20  
Pickup Dialling → Hot Line 32, 219  
PIN → Personal Identification Number 186  
Portable Station, Registration 14  
Portable Station, Using in Parallel with Wired Telephone 132  
Predialling 27  
Preferred Line Assignment—Incoming 190  
Preferred Line Assignment—Outgoing 190  
Preventing Other People from Using Your Telephone (Extension Dial Lock) 110  
Primary Directory Number (PDN) Button 22, 201  
Printing Message 158  
Privacy Release 77  
PROGRAM Button 19  
Programmable Feature (PF) Button 20  
Purchase Information 9

**Q**

Quick Dialling 33

**R**

Redial 34

Redial Button 17

Refusing Incoming Calls (Do Not Disturb [DND]) 120

Relay → External Relay 143

Release Button 20, 22, 54, 201

Remote COS Access 45, 220

Remote Extension Dial Lock 174, 227

Remote Setting 49, 220

Remote Station Lock Control → Remote Extension Dial Lock 174, 227

Remote Wake-up Call 156

Reorder Tone 232

Restriction Level Control (Dial Tone Transfer) 177

Revision History, KX-TDA100/KX-TDA200 PMPR Software File Version  
1.1xxx 235Revision History, KX-TDA100/KX-TDA200 PMPR Software File Version  
2.0xxx 92, 236Revision History, KX-TDA100/KX-TDA200 PMPR Software File Version  
3.0xxx 237Revision History, KX-TDA100/KX-TDA200 PMPR Software File Version  
3.2xxx 238

Revision History, KX-TDA30 PSMMPR Software File Version 1.1xxx 239

Revision History, KX-TDA30 PSMMPR Software File Version 2.0xxx 240

Revision History, KX-TDA30 PSMMPR Software File Version 2.2xxx 241

Revision History, KX-TDA30 PSMMPR Software File Version 3.0xxx 242

Revision History, KX-TDA30 PSMMPR Software File Version 4.0xxx 243

Revision History, KX-TDA600 PLMPR Software File Version 3.1xxx 234

Ring Tones 230

Ringback Tones 232

Ringing Method (Ring/Voice) 44

**S**

Safety Instructions 5

S-CO → Single-CO 21

Screening Calls (Live Call Screening [LCS]) 148

SDN Direct Dial 85

SDN Extension 84

SDN Walking COS 86

SDN → Secondary Directory Number 84

Secondary Directory Number (SDN) Button 22, 201

SELECT Button 20

Sensor → External Sensor 144

Setting Your Telephone, Personal 186

Setting Your Telephone, Remotely 49

Settings, Changing Other Extension's 174

Settings, Feature 188

Settings, Keeping when Changing Extensions 159

Settings, Personal 186

Settings, Programming Mode 188

Settings, System 207

SHIFT Button 20

Single-CO (S-CO) Button 21, 199

Soft Buttons 18

SP-PHONE Button 17

Standard SDN Key Mode 85

Station Programme Clear → Extension Feature Clear 133, 226

Station Speed Dialling → Personal Speed Dialling 30, 219

Storing Names and Numbers 165

System Alarm Button 21, 200

System Feature Access 172

System Password 207

System Programming 207, 210

System Programming Information 207

System Programming, Icon Descriptions 208

System Speed Dialling 31, 219

System Speed Dialling Name [002] 212

System Speed Dialling Number [001] 211

**T**

TAFAS → Trunk Answer From Any Station 53

Talking to Two Parties Alternately (Call Splitting) 65

Telephone Number, Hiding 125, 126

Telephone Number, Sending 124

Telephone Numbers, Storing 165

Telephone Types 14

Terminate Button 21, 200

Three-party Conference [3PTY]—by ISDN 77, 222

TIE Line Access 27, 219

Time Service (Day/Night/Lunch/Break) Button 21, 130, 175, 200,  
227

Time Service Mode, Control 175

Time Service Mode, Status 130

Time Service Switching Mode (Automatic/Manual) Button 22, 175, 201

Time Service Switching Mode (Automatic/Manual), Select 175

Timed Reminder 118, 224

Toll Restriction/Call Barring Button 22, 201

Tone Types 230

TRANSFER Button 18

Transfer, SDN Button 87

Transfer, To PDN Extension 87

Transferring Calls, After Paging 112

Transferring Calls, ISDN Service 59

Transferring Calls, To Other Extension 57

Transferring Calls, To Outside Party 58

Troubleshooting 216

Trunk Answer From Any Station (TAFAS) 53, 221

Trunk Busy Out 182, 228

Two-way Record 150

Two-way Record Button 22, 201

Two-way Transfer 150

Two-way Transfer Button 22, 201

**U**

Unattended Conference 75

**V**

Verification Code Entry 45, 220

VOICE CALL/MUTE Button 19

Voice Mail Integration 146, 227

Voice Mail Transfer 146

Voice Mail Transfer Button 22, 146, 201

Voice Mail, Call Forwarding 146

Voice Mail, Monitoring → Live Call Screening (LCS) 148

Voice Mail, Recording Conversation 150

Voice Messages 97

## Index

---

Voice Messages, Leaving 102  
Voice Messages, Listening to 103  
Voice Processing System 146  
Volume Key 15, 20

## W

Walking COS 45  
Walking Extension 159, 227  
Walking Station → Walking Extension 159, 227  
Warning Tone 232  
When the Dialed Line is Busy or There is No Answer 35  
Whisper OHCA 123, 224  
Wireless XDP Parallel Mode 132, 226  
Wrap-up 134  
Wrap-up Button 21, 200

## Y

Your Extension Number 15



**Panasonic Communications Co., Ltd.**

1-62, 4-chome, Minoshima, Hakata-ku, Fukuoka 812-8531, Japan

**Copyright:**

This material is copyrighted by Panasonic Communications Co., Ltd., and may be reproduced for internal use only. All other reproduction, in whole or in part, is prohibited without the written consent of Panasonic Communications Co., Ltd.

© 2005 Panasonic Communications Co., Ltd. All Rights Reserved.